

---



---

**UNITED STATES  
SECURITIES AND EXCHANGE COMMISSION**

Washington, D.C. 20549

---

**FORM F-1**

REGISTRATION STATEMENT  
*UNDER*  
*THE SECURITIES ACT OF 1933*

---

**Belite Bio, Inc**

(Exact name of Registrant as specified in its charter)

---

**Not Applicable**

(Translation of Registrant's name into English)

**Cayman Islands**  
(State or other jurisdiction of  
incorporation or organization)

**2834**  
(Primary Standard Industrial  
Classification Code Number)

**Not Applicable**  
(I.R.S. Employer  
Identification Number)

**5820 Oberlin Drive, Suite 101,  
San Diego, CA 92121  
Telephone: +1-858-246-6240**

(Address, including zip code, and telephone number, including area code, of Registrant's principal executive offices)

---

**Puglisi & Associates  
850 Library Avenue, Suite 204  
Newark, Delaware 19711  
(302) 738-6680**

(Name, address, including zip code, and telephone number, including area code, of agent for service)

---

*Copies to:*

**Portia Ku, Esq.  
Vincent Lin, Esq.  
O'Melveny & Myers LLP  
Times Square Tower  
7 Times Square  
New York, NY 10036  
+1-212-326-2000**

**Yu-Hsin Lin  
Belite Bio, Inc  
5820 Oberlin Drive, Suite 101,  
San Diego, CA 92121  
+1-858-246-6240**

**Richard Anslow, Esq.  
John J. Hart, Esq.  
Ellenoff Grossman & Schole LLP  
1345 Avenue of the Americas, 11<sup>th</sup> Floor  
New York, New York 10105  
+1-212-370-1300**

---

**Approximate date of commencement of proposed sale to the public:  
As soon as practicable after the effective date of this registration statement.**

If any of the securities being registered on this Form are to be offered on a delayed or continuous basis pursuant to Rule 415 under the Securities Act of 1933, check the following box.

If this Form is filed to register additional securities for an offering pursuant to Rule 462(b) under the Securities Act, check the following box and list the Securities Act registration statement number of the earlier effective registration statement for the same offering.

If this Form is a post-effective amendment filed pursuant to Rule 462(c) under the Securities Act, check the following box and list the Securities Act registration statement number of the earlier effective registration statement for the same offering.

---

If this Form is a post-effective amendment filed pursuant to Rule 462(d) under the Securities Act, check the following box and list the Securities Act registration statement number of the earlier effective registration statement for the same offering.

Indicate by check mark whether the registrant is an emerging growth company as defined in Rule 405 of the Securities Act of 1933.

Emerging growth company

If an emerging growth company that prepares its financial statements in accordance with U.S. GAAP, indicate by check mark if the registrant has elected not to use the extended transition period for complying with any new or revised financial accounting standards<sup>†</sup> provided pursuant to Section 7(a)(2)(B) of the Securities Act.

<sup>†</sup> The term “new or revised financial accounting standard” refers to any update issued by the Financial Accounting Standards Board to its Accounting Standards Codification after April 5, 2012.

---

**The Registrant hereby amends this Registration Statement on such date or dates as may be necessary to delay its effective date until the Registrant shall file a further amendment which specifically states that this Registration Statement shall thereafter become effective in accordance with Section 8(a) of the Securities Act of 1933 or until the Registration Statement shall become effective on such date as the Securities and Exchange Commission, acting pursuant to said Section 8(a), may determine.**

---

---

**PRELIMINARY PROSPECTUS (Subject to Completion)**  
**Dated** , 2022.

**American Depositary Shares**



**Belite Bio, Inc**

**Representing Ordinary Shares**

We are selling American depositary shares, or ADSs. Each ADS represents one ordinary share, par value US\$0.0001 per share. This is an initial public offering in the United States of Belite Bio, Inc, a Cayman Islands exempted holding company with headquarters in San Diego, California and operations in the United States and Australia.

Throughout this prospectus, unless the context indicates otherwise, references to “Belite” refer to Belite Bio, Inc, a holding company, together as a group with our subsidiaries, including our operating subsidiaries: Belite Bio, LLC and RPA Pty Ltd, our U.S. and Australia-based operating subsidiaries, respectively, conduct our daily operations. Investors purchasing our ADSs in this initial public offering are purchasing equity securities of our Cayman Islands exempt holding company and are not purchasing equity securities of our operating subsidiaries in the United States and Australia. In the normal course of our business, Belite would evaluate the financial condition and capital needs of our subsidiaries periodically and then provide funding for their operations via equity investments and intercompany loans. As of the date of this prospectus, we have provided US\$10.06 million to our subsidiaries via capital contribution, including US\$0.2 million intercompany loans that have been repaid by the subsidiary via the issuance of ordinary shares, among which we have provided US\$60,000 to our Hong Kong subsidiary via capital contribution which further invested US\$50,000 to our PRC subsidiary via capital contribution. None of our subsidiaries have declared or paid any dividends or distributions on equity to their respective holding companies as of the date of this prospectus. We have not relied, and do not expect to rely, on dividends or other distributions on equity from any of our subsidiaries for our cash requirements. We have no plans to declare cash dividends in the near term, but as a holding company, we may depend on receipt of funds from one or more of our subsidiaries if we determine to pay cash dividends to holders of our ordinary shares in the future. While our PRC subsidiary has no operations and generates no revenue as of the date of this prospectus, should it generate revenue in the future, restrictions on currency exchanges in China may limit our ability to freely convert such Renminbi to fund any future business activities outside China or other payments in U.S. dollars, and capital control measures imposed by the Chinese government may limit our ability to use capital from our PRC subsidiary for business purposes outside of China. See “Prospectus Summary — Cash Transfers and Dividend Distribution” for a more detailed description.

All of our operations are outside of PRC as of the date of this prospectus although we have established a subsidiary in each of Hong Kong and China. We do not expect the listing of our ADSs to be materially affected by recent statements by the Chinese government indicating an intent to exert more oversight and control over offerings that are conducted overseas and/or foreign investment in China-based issuers, including, but not limited to, the cybersecurity review and other regulatory reviews of overseas listing through an offshore holding company. However, due to the extraterritorial reach (the so-called “long arm provisions”) under the current PRC laws and regulations, there remains regulatory uncertainty with respect to the implementation and interpretation of laws in China.

In the event that we elect to carry out clinical trials in China and/or expand our operations into China in the future (see “Business” beginning on page 112 for our current plans for future clinical trials), there may be certain legal and operational risks associated with having certain operations in China, including that changes in the legal, political and economic policies of the Chinese government, the relations between China and the United States, or Chinese or United States regulations may materially and adversely affect our business, financial condition, results of operations and the market price of our ADSs. Any such changes may significantly limit or completely hinder our ability to offer or continue to offer our ADSs to investors, and may cause the value of our ADSs to significantly decline or become worthless. For more information on these risks and other risks you should consider before buying our ADSs, see “Risk Factors” beginning on page 15.

Furthermore, as more stringent criteria, including the Holding Foreign Companies Accountable Act, or the HFCAA, have been imposed by the SEC and the Public Company Accounting Oversight Board, or the PCAOB, recently, our ADSs may be prohibited from trading in the United States if our auditor cannot be fully inspected. Our auditor, Friedman LLP, the independent registered public accounting firm that issued the audit report included in this prospectus, is a firm registered with the PCAOB. Friedman LLP is headquartered in Manhattan, New York and has been inspected by the PCAOB on a regular basis. Therefore, we believe that, as of the date of this prospectus, our auditor is not subject to the determinations announced by the PCAOB on December 16, 2021 relating to the PCAOB’s inability to inspect or investigate completely registered public accounting firms headquartered in mainland China of the PRC or Hong Kong because of a position taken by one or more authorities in the PRC or Hong Kong. For more information on these risks and other risks you should consider before buying our ADSs, see “Risk Factors” beginning on page 17. We cannot assure you whether Nasdaq or other regulatory authorities will apply additional or more stringent criteria to us. Such uncertainty could cause the market price of our ADSs to be materially and adversely affected.

Prior to this offering, there has been no public market for our ordinary shares or ADSs. We anticipate that the initial public offering price of the ADSs will be between US\$ and US\$ per ADS. In connection with this offering, we have applied for the listing of the ADSs on the Nasdaq Capital Market under the symbol “BLTE.”

Upon the completion of this offering, Lin Bioscience International Ltd., our principal shareholder, will hold more than 50% of the shareholder voting power of our outstanding share capital, as further described under “Principal Shareholders” in this prospectus. As a result, our principal shareholder could exert substantial influence over matters such as electing directors and approving material mergers, acquisitions, strategic collaborations or other business combination transactions. As a result, we are a “controlled company” as defined under the Nasdaq Stock Market Rules. For so long as we remain a controlled company as defined under that rule, we are exempt from, and our shareholders generally are not provided with the benefits of, some of the Nasdaq Stock Market corporate governance requirements.

We are an “emerging growth company” and a “foreign private issuer” under applicable U.S. federal securities laws and are eligible for reduced public company reporting requirements.

Lin Bioscience International Ltd., our principal shareholder, has indicated an interest to purchase up to US\$15.0 million of ADSs in this offering, which will represent no more than 50% of the total ADSs in this offering such that we still meet the un-affiliated float listing criteria of the Nasdaq Capital Market. Because indications of interest are not binding agreements or commitments to purchase, Lin Bioscience International Ltd. may determine to purchase fewer ADSs than it has indicated an interest in purchasing or not to purchase any ADSs in this offering.

**Investing in the ADSs involves risks. See “Risk Factors” beginning on page 17 for factors you should consider before buying the ADSs.**

**PRICE US\$ PER ADS**

Neither the United States Securities and Exchange Commission nor any other regulatory body has approved or disapproved of these securities or determined if this prospectus is truthful or complete. Any representation to the contrary is a criminal offense.

	Per ADS	Total
Initial public offering price	US\$	US\$
Underwriting discounts and commissions <sup>(1)</sup>	US\$	US\$
Proceeds, before expenses, to us	US\$	US\$

(1) See “Underwriting” for additional information regarding compensation payable by us to the underwriters.

We have granted to the underwriters an option, for a period of 30 days after the date of this prospectus, to purchase up to an additional ADSs from us at the public offering price per ADS, less underwriting discounts and commissions.

The underwriters expect to deliver the ADSs to purchasers on or about , 2022.

*Book-Running Manager*

**THE BENCHMARK COMPANY**

**The date of this prospectus is** , 2022.

The information in this preliminary prospectus is not complete and may be changed. We may not sell these securities until the registration statement filed with the Securities and Exchange Commission is effective. This preliminary prospectus is not an offer to sell these securities and we are not soliciting offers to buy these securities in any state where the offer or sale is not permitted.

## TABLE OF CONTENTS

<a href="#">Prospectus Summary</a>	<a href="#">1</a>
<a href="#">Risk Factors</a>	<a href="#">17</a>
<a href="#">Special Note Regarding Forward-Looking Statements</a>	<a href="#">86</a>
<a href="#">Use of Proceeds</a>	<a href="#">88</a>
<a href="#">Dividend Policy</a>	<a href="#">89</a>
<a href="#">Capitalization</a>	<a href="#">90</a>
<a href="#">Dilution</a>	<a href="#">92</a>
<a href="#">Enforceability of Civil Liabilities</a>	<a href="#">94</a>
<a href="#">Corporate History and Structure</a>	<a href="#">96</a>
<a href="#">Selected Consolidated Financial Data</a>	<a href="#">97</a>
<a href="#">Management's Discussion and Analysis of Financial Condition and Results of Operations</a>	<a href="#">98</a>
<a href="#">Business</a>	<a href="#">112</a>
<a href="#">Regulations</a>	<a href="#">138</a>
<a href="#">Management</a>	<a href="#">167</a>
<a href="#">Principal Shareholders</a>	<a href="#">175</a>
<a href="#">Related Party Transactions</a>	<a href="#">177</a>
<a href="#">Description of Share Capital</a>	<a href="#">182</a>
<a href="#">Description of American Depositary Shares</a>	<a href="#">194</a>
<a href="#">Shares Eligible for Future Sale</a>	<a href="#">204</a>
<a href="#">Taxation</a>	<a href="#">206</a>
<a href="#">Underwriting</a>	<a href="#">211</a>
<a href="#">Expenses Related to this Offering</a>	<a href="#">222</a>
<a href="#">Legal Matters</a>	<a href="#">223</a>
<a href="#">Experts</a>	<a href="#">224</a>
<a href="#">Where You Can Find Additional Information</a>	<a href="#">225</a>
<a href="#">Index to Consolidated Financial Statements</a>	<a href="#">F-1</a>

Until \_\_\_\_\_, 2022 (the 25th day after the date of this prospectus), all dealers that effect transactions in these ADSs, whether or not participating in this offering, may be required to deliver a prospectus. This is in addition to the dealers' obligation to deliver a prospectus when acting as an underwriter and with respect to their unsold allotments or subscriptions.

You should rely only on the information contained in this prospectus or in any free writing prospectus that we authorize to be distributed to you. We and the underwriters have not authorized anyone to provide you with any information other than that contained in this prospectus or in any free writing prospectus prepared by or on behalf of us or to which we have referred you, and neither we, nor the underwriters, take responsibility for any other information others may give you. We are offering to sell, and seeking offers to buy the ADSs, only in jurisdictions where such offers and sales are permitted. The information in this prospectus or any free writing prospectus is accurate only as of its date, regardless of its time of delivery or the time of any sale of the ADSs. Our business, financial condition, results of operations and prospects may have changed since that date.

Neither we nor any of the underwriters has taken any action to permit a public offering of the ADSs outside the United States or to permit the possession or distribution of this prospectus or any filed free writing prospectus outside the United States. Persons outside the United States who come into possession of this prospectus or any filed free writing prospectus must inform themselves about and observe any restrictions relating to the offering of the ADSs and the distribution of the prospectus or any filed free writing prospectus outside the United States.



## PROSPECTUS SUMMARY

*The following summary is qualified in its entirety by, and should be read in conjunction with, the more detailed information and financial statements appearing elsewhere in this prospectus. In addition to this summary, we urge you to read the entire prospectus carefully, especially the risks of investing in the ADSs discussed under “Risk Factors” and information contained in “Management’s Discussion and Analysis of Financial Condition and Results of Operations” before deciding whether to invest in the ADSs.*

### Overview

We are a clinical stage biopharmaceutical drug development company focused on novel therapeutics targeting currently untreatable eye diseases involving retinal degeneration such as atrophic age-related macular degeneration (commonly known as dry AMD) and autosomal recessive Stargardt disease, or STGD1, both of which progressively lead to permanent blindness, and metabolic diseases such as non-alcoholic fatty liver disease, or NAFLD, nonalcoholic steatohepatitis, or NASH, type 2 diabetes, or T2D, and gout.

### **LBS-008**

We believe our lead product candidate, LBS-008, or Tinarebant, if approved, would provide a novel treatment option where there currently is none. LBS-008 is an oral once-a-day treatment that can reduce and maintain the delivery of vitamin A (retinol) to the eye as a means to reduce the accumulation of toxic vitamin A by-products in ocular tissue. This effect is achieved through the ability of LBS-008 to reduce and maintain the level of serum retinol binding protein 4, or RBP4, which carries retinol from the liver to the eye. In clinical trials, LBS-008 has demonstrated its target specificity and potency that we believe could be clinically meaningful to treat STGD1 patients. We initiated an open-label, dose-finding Phase 1b/2 clinical trial in adolescent STGD1 patients in mid-2020 in Australia and Taiwan. The study design includes two portions: Phase 1b and Phase 2. We have completed the Phase 1b portion of this study in 11 adolescent STGD1 patients which has extended into a two-year, Phase 2 study with 13 adolescent STGD1 patients in Australia and Taiwan. The preliminary data from the Phase 1b portion has shown that LBS-008 can achieve a mean RBP4 reduction of > 70%, relative to baseline values. We are currently conducting the Phase 2 portion of this study. See “—Phase 1b/2 Clinical Trial in STGD1” below for more information.

As of the date of this prospectus, we have initiated our Phase 3 clinical trial, to evaluate the safety and efficacy of LBS-008 in adolescent STGD1 patients and received approval to commence patient enrollment in Taiwan, the U.K., Hong Kong and Switzerland. In addition, we are in the process of applying for the necessary approvals to conduct the same clinical trial in other relevant jurisdictions.

STGD1 is a rare monogenetic juvenile-onset macular dystrophy that is characterized by the aberrant and excessive accumulation of toxic vitamin A by-products known as bisretinoids and cellular debris, or lipofuscin, which precedes the death of retinal tissue and loss of vision. Although an orphan disease, STGD1 is the most common juvenile macular degeneration. Dry AMD is a heterogenous condition that arises from a complex interplay between age, genetics and environmental factors, such as diet and smoking, but has a pathology and course of disease that strongly resembles that of STGD1, particularly in intermediate and advanced stages. There are no approved therapies for STGD1 or dry AMD.

Developed from our RBP4 intellectual property portfolio, or RBP4 IP Portfolio, LBS-008 was designed to be a potent and reversible RBP4 antagonist. As an RBP4 antagonist, LBS-008 reduces the amount of retinol entering the visual cycle thereby reducing the formation of bisretinoid toxins which will ultimately preserve the health of the retina. We hold a worldwide exclusive license of the RBP4 IP Portfolio from Columbia University, which contains disclosure directed to over 400 structurally distinct RBP4 antagonists under patent protection in major pharmaceutical markets worldwide, including the United States, the European Union, China, Australia, Japan, South Korea and India.

LBS-008 has received orphan drug designation for the treatment of STGD1 in the United States, which entitles it to market exclusivity such that the U.S. Food and Drug Administration, or FDA, may not approve any other applications for the same product for the same indication for 7 years, except in very limited circumstances. See “Regulations — U.S. Regulation — NDA Submission and Review — Orphan Drug

Designation and Exclusivity” for more information. LBS-008 has also received orphan designation for the treatment of STGD1 in Europe, which entitles it to a 10 year period of market exclusivity, which may be reduced in certain circumstances. During this market exclusivity period, neither the European Medicines Agency, or EMA, nor the European Commission or the member states can accept an application for, or grant a marketing authorization for, a “similar medicinal product.” See “Regulations — European Regulation — Orphan Designation and Exclusivity” for more information. Additional benefits of an orphan drug designation include a tax credit of 50% of the qualified clinical testing expenses for the relevant taxable year and a waiver of the new drug application, or NDA, application fee (which is approximately \$3.1 million for fiscal year 2022).

LBS-008 has also received rare pediatric disease designation in the United States and may be eligible for a priority review voucher. A priority review voucher may be awarded to a sponsor if it develops a drug for a rare pediatric disease and the drug is approved. The priority review voucher allows the sponsor of a subsequent NDA or Biologic License Application for any product candidate to expedite the FDA’s review goal from 10 months to 6 months. The priority review voucher may be sold to other companies that seek to expedite drug reviews. See “Regulations — U.S. Regulation — NDA Submission and Review — Rare Pediatric Disease Designation and Priority Review Vouchers” for more information. In the last three years, priority review vouchers have sold in a price range between \$80-125 million. In the event that we or a sublicensee chooses to sell a priority review voucher, we or such sublicensee would be obligated to pay Columbia University a percentage of revenue in the low double-digits that we or such sublicensee receives from any such sale pursuant to the Columbia License Agreement. In the event that we or a sublicensee does not sell a priority review voucher within one year of receipt, the earned royalties that we would be obligated to pay to Columbia University based on net sales of licensed products would increase by 1%. See “Business — Intellectual Property — Patents — Patent License Agreement with The Trustees of Columbia University in the City of New York” for more information.

LBS-008 is the only drug candidate within the current drug development projects of the National Institute of Health (NIH) Blueprint Neurotherapeutics Network, or the BPN, that is intended to treat dry AMD. The BPN was launched in 2004 to foster small-molecule neurotherapeutic development, bringing together a unique blend of grant dollars, industry-standard scientific expertise, and contract resources under a milestone-driven cooperative agreement program. The BPN criteria for selection of clinical drug candidates are based on multiple features of an applicant’s drug development program including the following: 1) strong biological rationale, 2) novel target for the disease, 3) strong data linking target to disease, 4) demonstration of preclinical pharmacodynamic effect and efficacy, 5) feasible path to clinic, and 6) IP free of roadblocks. LBS-008 was selected by the BPN in 2011 and, as of the date of this prospectus, is the only drug candidate within the current drug development projects of the BPN that is intended to treat dry AMD.

The mechanism of action utilized by LBS-008 has been recognized and recommended as a priority for clinical development in both STGD1 and dry AMD in a systematic review published by the U.K. National Institute for Health Research, or the NIHR, in 2018. The NIHR is funded by the U.K. Department of Health and Social Care and focuses on early translational research, clinical research and applied health and social care research for the purpose of enabling and delivering world-leading health and social care research that improves people’s health and wellbeing and promotes economic growth. The NIHR screened 7,948 articles in 2018 for its systematic review on treatments for dry AMD and STGD1. Its principal findings included that research focus should be at earlier stages in both diseases (before vision is impaired) and that the most promising treatments for both diseases appear to be prevention of lipofuscin and bisretinoid accumulation. Therefore, the NIHR recommended the mechanism of RBP4 inhibition, which is utilized by LBS-008, as a promising treatment in dry AMD and STGD1.

Although there are currently no approved treatments available for macular degeneration, our competitors for LBS-008 include several companies going through clinical development for their product candidates. Based on publicly available information, we understand that there is one Japan-based pharmaceutical company that has an asset in Phase 3 development for STGD1. There are also three U.S.-based companies advancing treatments for STGD1 and their assets are currently in Phase 2 and Phase 2b development, respectively, with the third company having recently completed their Phase 2a trial. In geographic atrophy, or GA, there are five U.S.-based companies in late-stage clinical development, three of which have assets in Phase 3 development and two of which have assets in Phase 2 development.

#### *Clinical Trials in Healthy Adult Subjects*

To support the clinical development of LBS-008, we have completed one randomized, double-blind, placebo-controlled, Phase 1 SAD study in 40 healthy adult subjects in the United States, one randomized, double-blind, placebo-controlled, Phase 1 single ascending dose, or SAD, study in 39 healthy adult subjects and one randomized, double-blind, placebo-controlled, Phase 1 multiple ascending dose, or MAD, study in 32 healthy adult subjects in Australia. These studies were conducted to confirm the safety, toxicity, pharmacokinetics, or PK, and pharmacodynamics, or PD of LBS-008 on a range of single ascending dose (10-50 mg in the US; 25-400 mg in Australia) / multiple ascending dose (5-25 mg in Australia) levels in healthy adult subjects in fasted / fed conditions.

In the US SAD study, we found that single doses of 10–50 mg LBS-008 were well tolerated and reduced mean serum RBP4 level by around 70% from baseline. The degree of lowering of RBP4 plasma concentrations increased with increasing LBS-008 dose. This study also compared doses of LBS-008 taken with and without food, which did not show a food effect with dosing.

In the Australian SAD study, we found that single doses of 25-400 mg LBS-008 were well tolerated and reduced mean RBP4 level by > 70% from baseline. One subject in the 100 mg cohort experienced a drug-related adverse event of mild transient xanthopsia. That event was resolved within 48 hours. A direct correlation between the LBS-008 plasma concentration and RBP4 suppression was observed.

In the Australian MAD study, we found that all dose levels were well tolerated and have identified an optimal daily dose to reduce serum RBP4 by > 70% from baseline. Most drug-related adverse events reported were mild in severity, and the most frequently reported drug-related adverse event was asymptomatic Delayed Dark Adaptation, or DDA, which did not show dose proportionality and reflects a reduction in vitamin A levels in the eye, which is the intended effect of LBS-008. No deaths, serious or severe adverse events were reported. The Safety Review Committee, or SRC, approved dose escalations after reviewing the safety data profile at each dose level.

#### *Stargardt Disease*

In STGD1, we are developing LBS-008 as an oral daily treatment to target RBP4 by disrupting vitamin A (retinol) binding to RBP4 which leads to reduced delivery of retinol to the eye and reduced accumulation of toxic vitamin A by-products.

STGD1 is an inherited juvenile form of macular degeneration and currently, there is no approved treatment available. The disease is caused by a mutation in the ABCA4 gene, which leads to the accelerated formation and accumulation of toxic vitamin A by-products known as bisretinoids. The most prominent bisretinoid identified in human tissues is known as A2E (*N*-retinylidene-*N*-retinylethanolamine). The accumulation of A2E in ocular tissues causes progressive retinal cell death and permanent loss of vision. More than 500 mutations in the ABCA4 gene have been identified in STGD1 patients. Some STGD1 patients suffer severe visual impairment by the age of 20. The prevalence rate of STGD1 is estimated to be 1 in 10,000 people. Based on this estimate, approximately 30,000 US citizens are affected by STGD1. This estimate includes both adults and children. Although comprehensive epidemiological data on the prevalence of STGD1 in other countries is not available, the epidemiological literature from other countries, such as Europe and Asian countries, cite the 1 in 10,000 estimate for the prevalence of STGD1.

#### *Phase 1b/2 Clinical Trial in STGD1*

We have completed the Phase 1b portion of a Phase 1b/2 open-label, dose-finding study in 11 adolescent STGD1 patients which has extended into a two-year, Phase 2 study with 13 adolescent STGD1 patients in Taiwan and Australia. The Phase 1b portion is a dose-finding study designed to determine the optimal dose of LBS-008 and to evaluate safety, tolerability, PK and PD in adolescent STGD1 patients for a treatment period of 2 cycles of 14-day daily dosing of LBS-008 (28 days of daily treatment) and a 14-day follow-up period. Upon completion of Phase 1b, an optimal daily dose was identified and which was able to achieve a mean RBP4 reduction of > 70%, relative to baseline values.

The preliminary data shows that most frequently reported drug-related adverse events reported to date included DDA and transient xanthopsia, which were all graded as mild. Reports of transient DDA/night

vision impairment and xanthopsia were anticipated and are consistent with LBS-008's mechanism of action. It is notable that in most incidences of DDA, it was confirmed by laboratory measure (dark adaptometry) as the majority of patients were asymptomatic. No deaths or serious or severe Treatment-emergent adverse events, or TEAEs, were reported. In addition, there were no clinically significant findings in relation to vital signs, physical exams, or electrocardiograms, or ECGs.

The Phase 2 portion consists of a 2-year treatment period with a follow-up period of one month. In the Phase 2 portion of the study, in addition to monitoring the safety and tolerability, we aimed to monitor PK and PD biomarkers (RBP4 and retinol) and the effects of treatment using various retinal imaging modalities (including definitely decreased autofluorescence, or DDAF, questionably decreased autofluorescence, or QDAF, Spectral-domain optical coherence tomography, or SD-OCT, and microperimetry), change in best-corrected visual acuity, or BCVA, and the relationship between the change in RBP4 levels and rate of lesion growth.

We are currently conducting the Phase 2 portion of this study. A total of 13 adolescent STGD1 patients were enrolled in the Phase 2 portion of the Phase 1b/2 study. As of the date of this prospectus, all 13 patients have received at least 6 months of treatment and completed the scheduled assessments at the first 6 month interval. Change in BCVA (early treatment diabetic retinopathy study, or ETDRS letter score), and fundus autofluorescence, or FAF, imaging results at 6-months are compared to the baseline measurements at the start of Phase 2. The preliminary data shows that 8 of the 13 patients (or 61.5%) recorded a gain in BCVA (ETDRS letter score) in at least one eye, including 2 patients who recorded a gain in BCVA in both eyes. The average BCVA from the 13 patients was an average loss of 2.8 letters in the right eye, and an average gain of 1.9 letters in the left eye. On FAF retinal imaging, 8 of the 13 patients (or 61.5%) had a reduction or no change in their QDAF area size in at least one eye, including 5 patients who had a reduction or no change in QDAF area size in both eyes. There was an average gain in QDAF area in the right eye of  $0.2 \pm 0.09\text{mm}^2$  (Mean  $\pm$  standard error of the mean, or SEM) and in the left eye of  $0.1 \pm 0.09\text{mm}^2$  (Mean  $\pm$  SEM). While 12 of the 13 patients had no DDAF lesion measured at the start of Phase 2 and at 6-months, 1 of the 13 patients had a DDAF lesion growth of  $0.3\text{mm}^2$  in both eyes during the 6-month period. On SD-OCT imaging, a gradual thinning with an average of approximately 7 to 10 microns (on total retinal thickness by ETDRS regions) was observed in both eyes. In the Ellipsoid Zone (EZ), an average increase in defect width of 0.26mm in the right eye and 0.61mm in the left eye were observed. However, 6 patients had a reduction in EZ defect width in at least 1 eye (including 3 patients in both eyes). Additional interim data read-outs will be captured at Months 12, 15, 18 and 21, and a final data read-out will be captured at Month 24.

#### *Phase 3 Clinical Trial in STGD1*

As of the date of this prospectus, we have initiated a randomized, double-masked, placebo-controlled, global, multi-center, Phase 3 clinical trial, to evaluate the safety and efficacy of LBS-008 in adolescent STGD1 patients and received approval to commence patient enrollment in Taiwan, the U.K., Hong Kong and Switzerland. In addition, we are in the process of applying for the necessary approvals to conduct the same clinical trial in other relevant jurisdictions. This study consists of a screening period, a treatment period of 2 years, and a follow-up period of one month. Approximately 60 patients are targeted for enrollment in this study with a 2:1 randomization (active:placebo). See "Risk Factors — In the event that we elect to carry out clinical trials in China and/or expand our operations into China in the future, we will be subject to changing legal and regulatory requirements in the PRC pharmaceutical industry, and new laws, rules and regulations may adversely affect our profitability or impose additional compliance burdens on us."

We intend to focus on adolescent patients in our ongoing clinical trials due to several benefits afforded by utilizing this patient population — namely, establishing proof-of-concept in the context of a more severe and rapidly progressing disease (i.e., STGD1 disease progression is faster in adolescent patients compared to adults or later-onset patients), and the ability to readily expand into the larger adult STGD1 population upon approval (i.e., drug approvals for pediatrics and/or adolescents are accepted for adults but drug approvals for adults are not accepted for pediatrics and/or adolescent populations due to safety concerns).

#### *Dry AMD*

Due to the strong pathophysiologic similarities between STGD1 and intermediate to advanced stages of dry AMD, we expect LBS-008 to have a similar treatment effect on this population of dry AMD patients.

AMD is an age-related form of macular degeneration. The most commonly used classification system for AMD is the Age-Related Eye Disease Study, or AREDS, classification system, which designates the following categories:

- Category 1 is designated as “No AMD,” although there may be a few small (<63µm in diameter) yellowish subretinal deposits (i.e., drusen beneath the retina).
- Category 2 is designated as “Early AMD” and is characterized by multiple small drusen (<20µm in diameter), a few intermediate drusen (63-124µm in diameter), and abnormalities of the retinal pigment epithelium, or RPE, a monolayer of epithelial cells that lies beneath the retina and provides trophic and metabolic support to photoreceptor cells of the retina.
- Category 3 is designated as “Intermediate AMD,” where there is extensive intermediate drusen, large drusen (>125µm in diameter), or geographic atrophy (i.e., localized atrophy of the retina), or GA, and increased lipofuscin in the RPE.
- Category 4 is designated as “Advanced AMD” and is characterized by GA or neovascular maculopathy (i.e., ‘wet’ AMD).

The only approved therapies for AMD are for ‘wet’ AMD which represents approximately 10% of all AMD cases. There are no approved therapies for the other stages of AMD, including GA, secondary to advanced AMD, which are collectively referred to as dry AMD and represents approximately 90% of all AMD cases. Importantly, dry AMD is a leading cause of vision loss in older adults. Thus, there is a significant unmet medical need in treating dry AMD patients. There are an estimated 11 million dry AMD patients in the United States and over 196 million patients worldwide with an estimated global direct healthcare cost of US\$255 billion.

Disease progression in early dry AMD is very slow. The American Optometric Association reports that most people move through the process from diagnosis to legal blindness in about 10 years. Therefore, investigational therapies have been directed at the treatment of intermediate and advanced stages of dry AMD, which progress more rapidly than earlier stages. Unlike STGD1, dry AMD is believed to have a very heterogeneous etiology, and various therapeutic approaches have been explored to slow disease progression in dry AMD. An important feature of Intermediate AMD is the aberrant and excessive accumulation of lipofuscin and bisretinoid toxins, similar to STGD1. In these stages of dry AMD, retinal lesions (i.e., GA) are bordered on all sides by an annulus of autofluorescence which expands in a centrifugal manner followed by lesion expansion into the autofluorescent area. *In vivo* analyses of the autofluorescent area in Intermediate AMD eyes revealed an excitation maxima and fluorescence emission that is consistent with the spectral properties of bisretinoid toxins. Thus, the clinical presentation and biochemical features of intermediate and advanced dry AMD suggest that a therapy directed at reducing the level of bisretinoid toxins may be effective to slow disease progression.

We are currently evaluating our plan to initiate, in 2022, a randomized, double masked, placebo-controlled, Phase 2 or Phase 3 trial, in the United States, Europe, and Asia Pacific. See “Risk Factors — In the event that we elect to carry out clinical trials in China and/or expand our operations into China in the future, we will be subject to changing legal and regulatory requirements in the PRC pharmaceutical industry, and new laws, rules and regulations may adversely affect our profitability or impose additional compliance burdens on us.” Our objective is to evaluate the efficacy and safety of LBS-008 in the treatment of dry AMD over the course of a two-year treatment period.

#### ***LBS-009***

LBS-009 is an anti-RBP4 oral therapy targeting liver disease, including NAFLD, NASH, and T2D.

NAFLD occurs when an excess accumulation of fat damages the liver. Currently, it is estimated that approximately 1.9 billion patients suffer from NAFLD worldwide. Over time, the liver damage and the associated inflammation can lead to the development of NASH, which impacts an estimate of more than 9 million patients in the United States alone. As the disease progresses, it can lead to cirrhosis and eventually, complete liver failure. NAFLD and NASH are a growing unmet need for which no FDA-approved treatments are currently available.

T2D is a chronic disease that occurs when the body cannot effectively use insulin, the hormone that regulates blood sugar levels. The health impact of T2D is profound, potentially causing damage to the eyes, heart, blood vessels, kidneys, and nerves. T2D is on the rise, with approximately 422 million patients globally.

LBS-009 is a small molecule designed to compete with retinol for RBP4 binding. When bound to LBS-009, RBP4 can no longer form a large molecular weight complex with transthyretin. Consequently, the RBP4/LBS-009 complex will be removed from circulation by renal filtration. We believe that modulating RBP4 concentrations systemically with LBS-009 has a significant therapeutic potential for treating patients suffering from metabolically associated diseases, including NAFLD, NASH and T2D.

LBS-009 is currently in preclinical development.

#### ***Our Management and Clinical Advisory Board***

Our management team and ophthalmology clinical advisory board have deep experience and capabilities in ophthalmology, neurology, immunology and immunotherapy, cardiovascular and renal medicine, oncology, neurobiology, biochemistry, drug discovery, clinical development, manufacturing, and commercialization. Our ophthalmology clinical advisory board includes key opinion leaders in the macular degeneration space, including Quan Nguyen, M.D., Professor of Ophthalmology at Stanford University, Hendrik P.N. Scholl, M.D., Professor and Chairman of the Department of Ophthalmology at University of Basel and Co-Director of the Institute of Molecular and Clinical Ophthalmology in Basel, Michel Michaelides, M.D., Consultant Ophthalmologist at Moorfields Eye Hospital and Professor of Ophthalmology, UCL Institute of Ophthalmology, Robyn Guymer, M.D., Professor of Ophthalmology, University of Melbourne and Deputy Director of the Centre for Eye Research Australia and Frank Holz, M.D., Chairman of Ophthalmology, University of Bonn. Together, our management team and ophthalmology clinical advisory board, in connection with our exclusive technology platform, will allow our drugs to be tailored to target at-risk patients across the United States and worldwide, who lack access to necessary treatment in the macular degeneration space.

#### **Our Program**

Our lead product candidate, LBS-008, is an RBP4 antagonist. We are developing LBS-008 as an oral daily treatment for STGD1 and dry AMD.

The following table summarizes key information about our clinical program for LBS-008:

<b>Indication</b>	<b>Clinical Trials</b>	<b>Trial Participants</b>	<b>Estimated Timeline</b>
STGD1	Phase 1 single and multiple ascending dose trial	Healthy adult subjects	Completed
	Phase 1b trial	Adolescent patients with STGD1	Completed
	Phase 2 trial	Adolescent patients with STGD1	Ongoing, with interim data read-outs expected to be captured at Months 12, 15, 18 and 21, and a final data read-out to be captured at Month 24.
	Phase 3 trial	Adolescent patients with STGD1	Initiated
Dry AMD	Phase 1 single ascending dose trial	Healthy adult subjects	Completed
	Phase 2 or Phase 3 trial	Patients with dry AMD	2022

Our ongoing and planned development plans and clinical trials may potentially be adversely impacted if the COVID-19 pandemic continues in the future. Specifically, the COVID-19 pandemic may lead to (i) delays in patient enrollment for our clinical trials and/or other services provided by the CROs, laboratories or hospitals engaged by or collaborated with us due to lockdown measures in various countries, (ii) delays or significant increase in expenses for obtaining and shipment of our drug candidates due to congestion at port or increased freight and (iii) delays in the FDA or other regulatory agencies review and approval processes as the FDA or other regulatory agencies may prioritize and focus on the approval of therapeutics treating COVID-19 than those treating other indications.

#### **Our Strengths**

We believe we are well placed to accomplish our mission due to the following strengths:

- Novel oral therapy to tap into a niche market for significant unmet medical needs.
- Pre-clinically and clinically demonstrated mechanism of action.
- Receipt of Orphan Drug Designation in the United States and Europe.
- Receipt of Rare Pediatric Disease Designation in the United States with Eligibility for Priority Review Voucher if approved.
- National Institute of Health Blueprint Neurotherapeutics Network sponsored and endorsed.
- U.K. National Institute for Health Research endorsed the mechanism of action utilized by LBS-008.
- Potential to treat intermediate to advanced-stage dry AMD with oral therapy for lifetime.
- Highly experienced senior management team supported by world-renowned advisory board and influential key opinion leaders.

#### **Our Strategies**

Our goal is to become a leading biopharmaceutical company with an aim to develop the first approved treatment on STGD1 and dry AMD globally. We intend to accomplish our mission by pursuing the following growth strategies:

- Efficiently advance our lead product candidate, LBS-008, through Phase 2 and Phase 3 clinical development in adolescent STGD1 patients and regulatory approval, with the potential to establish a new standard of care for STGD1 patients.
- Leverage the promising clinical data of LBS-008 in adolescent STGD1 patients to initiate Phase 2 or Phase 3 clinical development in dry AMD.
- Potentially advance LBS-009 through clinical development for the treatment of NAFLD and NASH.
- Continue to leverage our exclusive RBP4 IP Portfolio, and look for additional in-licensing or collaboration arrangements, to identify novel candidates to further expand our product pipeline and utilize our global organizational structure to advance programs into clinical development in a capital efficient manner.
- Evaluate strategic collaborations to maximize the value of our product candidates.

#### **Summary of Risk Factors**

There are a number of risks that you should understand before making an investment decision regarding this offering. These risks are discussed more fully in the section entitled "Risk factors" following this prospectus summary. These risks include, but are not limited to:

- Our business is highly dependent on the success of our lead product candidate, LBS-008. If we are unable to develop, obtain marketing approval for or successfully commercialize LBS-008, either alone or through a collaboration, or if we experience significant delays in doing so, our business could be harmed;

- All of our product candidates are in preclinical or clinical development. If we are unable to complete clinical development and obtain regulatory approval to ultimately commercialize our product candidates, or if we experience significant delays in doing so, our business, financial condition, results of operations and prospects will be materially harmed;
- We have recorded net cash outflow from operating activities since our inception. Even if we consummate this offering, we will need to obtain additional financing to fund our operations. If we are unable to obtain such financing, we may be unable to complete the development and commercialization of our product candidates;
- There is uncertainty regarding our ability to continue as a going concern, indicating the possibility that we may be required to curtail or discontinue our operations in the future;
- We have a limited operating history and no history of commercializing pharmaceutical products, which may make it difficult to evaluate the prospects for our future viability;
- The regulatory approval processes of the FDA, the TGA, the NMPA, the EMA and other comparable regulatory authorities are time-consuming and may evolve over time, and if we are ultimately unable to obtain regulatory approval for our product candidates, our business will be substantially harmed;
- All material aspects of the research, development, manufacturing and commercialization of pharmaceutical products are heavily regulated;
- If we are unable to obtain and maintain patent and other intellectual property protection for our product candidates, or if the scope of such intellectual property rights obtained is not sufficiently broad, third parties could develop and commercialize products and technologies similar or identical to ours and compete directly against us, and our ability to successfully commercialize any product or technology may be adversely affected;
- We depend on intellectual property licensed from third parties, and our current and future licensors may not always act in our best interest. If we fail to comply with our obligations under our intellectual property licenses, if the licenses are terminated or if disputes regarding these licenses arise, we could lose significant rights that are important to our business;
- If we fail to implement and maintain an effective system of internal controls, we may be unable to accurately report our results of operations, meet our reporting obligations or prevent fraud, and investor confidence and the market price of our ADSs may be materially and adversely affected;
- Our future success depends on our ability to attract, retain and motivate senior management and qualified scientific employees;
- As we rely on third parties to conduct our preclinical studies, clinical trials, contract manufacture drug substances and drug products, and provide other important services related to product development, regulatory submissions, and commercialization, if we lose our relationships with these third parties or if they do not successfully carry out their contractual duties, comply with applicable laws, or meet expected deadlines, we may not be able to obtain regulatory approval for or commercialize our product candidates and our business could be substantially harmed;
- We expect to seek to establish collaborations and, if we are not able to establish them on commercially reasonable terms, we may have to alter our development and commercialization plans; and
- As a result of our principal shareholder, Lin Bioscience International Ltd.'s significant share ownership position in us, it is able to influence corporate matters and a conflict of interest may arise between our principal shareholder and us.



### Corporate Structure

The chart below sets forth our corporate structure and identifies our significant subsidiaries and their significant subsidiaries, as of the date of this prospectus:

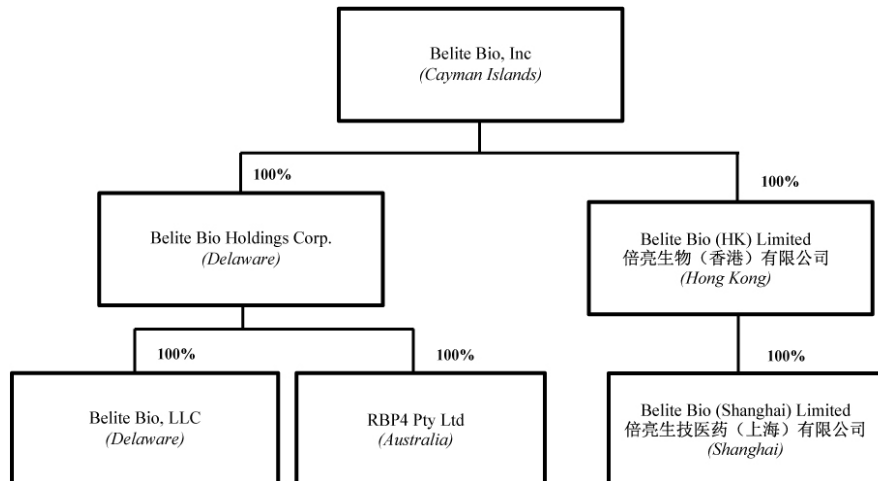

### Cash Transfers and Dividend Distribution

Our cash is primarily held by the holding company, Belite, and has been raised primarily through the issuance and sale of ordinary shares, convertible bonds, or convertible preferred shares in private placement transactions conducted by Belite.

Belite is permitted under the laws of the Cayman Islands to provide funding to our subsidiaries through capital contributions or loans, and there are currently no restrictions on transferring funds between our Cayman Islands holding company and subsidiaries in the U.S., Australia and Hong Kong. Our ability to make loans and additional capital contribution to our PRC subsidiary might be restricted by PRC law.

In the normal course of our business, Belite would evaluate the financial condition and capital needs of our subsidiaries periodically and then provide funding for their operations via equity investments and intercompany loans. As of the date of this prospectus, we have provided US\$10.06 million to our subsidiaries via capital contribution, including US\$0.5 million intercompany loans that have been repaid by the subsidiary via the issuance of ordinary shares, among which we have provided US\$60,000 to our Hong Kong subsidiary via capital contribution which further invested US\$50,000 to our PRC subsidiary via capital contribution. No other transfer of cash or other types of assets has been made between our Cayman Islands holding company and subsidiaries as of the date of this prospectus.

Our subsidiaries outside mainland China are permitted, under the respective laws of the U.S., Australia and Hong Kong, to provide funding to Belite through dividend distribution without restrictions on the amount of the funds. Our PRC subsidiary has no operations and generates no revenue as of the date of this prospectus, but should it generate revenue in the future, its ability to distribute dividends to us will be limited by foreign exchange restrictions. In addition, restrictions on currency exchanges in China may limit our ability to freely convert Renminbi to fund any future business activities outside China or other payments in U.S. dollars, and capital control measures imposed by the Chinese government may limit our ability to use capital from our PRC subsidiary for business purposes outside of China. Under existing PRC foreign exchange regulations, payments of current account items, including profit distributions, interest payments and trade and service-related foreign exchange transactions, can not be made in currencies other than Renminbi without complying with certain procedural requirements of the State Administration of Foreign Exchange, or SAFE. Specifically, approval from or registration with appropriate government authorities is required where Renminbi is to be converted into another currency and remitted out of China to pay

capital expenses, such as the repayment of loans denominated in currencies other than Renmibi. As a result, we may need to obtain SAFE approval to use cash generated from the operations of our PRC subsidiary to pay off its debt in a currency other than Renminbi owed to entities outside China, or to make other capital expenditure payments outside China in a currency other than Renminbi. On the other hand, the PRC Enterprise Tax Law (EIT Law) and its implementation rules provide that a withholding tax rate of up to 10% will be applicable to dividends payable by Chinese companies to non-PRC-resident enterprises unless otherwise exempted or reduced according to treaties or arrangements between the PRC central government and governments of other countries or regions where the non-PRC-resident enterprises are incorporated. As of the date of this prospectus, we have not received nor do we have any present plan to receive dividends paid by our U.S., Australia, Hong Kong and PRC subsidiaries.

As of the date of this prospectus, we did not adopt any specific cash management policies and procedures in relation to how funds are transferred within/through our group. Our management monitors the cash position of each entity within our group regularly, and prepares budgets for our subsidiaries on a monthly basis. In the event that there is a need for cash or a potential short-term cashflow shortages, it would be reported to our chief financial officer and, subject to the approval by our board of directors, we will enter into an intercompany loan arrangement for relevant subsidiary. Other than the above, we did not adopt or maintain any cash management policies and procedures as of the date of this prospectus.

Our Board of Directors has discretion as to whether to distribute dividends, subject to certain requirements of Cayman Islands law. In addition, subject to the provisions in our articles of association, our shareholders may by ordinary resolution declare a dividend not exceeding the amount recommended by our Board of Directors. As of the date of this prospectus, we have not paid and do not have any present plan to declare or pay any dividends in the foreseeable future. We currently intend to retain most of our available funds and any future earnings to fund the development and growth of our business. See “Risk Factors — Risks Related to This Offering and Our ADSs — Because we do not expect to pay dividends in the foreseeable future, you must rely on price appreciation of our ADSs for return on your investment” for more information.

#### **Implication of Being an Emerging Growth Company**

As a company with less than US\$1.07 billion in revenue for our last fiscal year, we qualify as an “emerging growth company” pursuant to the Jumpstart Our Business Startups Act of 2012, as amended, or the JOBS Act. An emerging growth company may take advantage of specified reduced reporting and other requirements compared to those that are otherwise applicable generally to public companies. These provisions include exemption from the auditor attestation requirement under Section 404 of the Sarbanes-Oxley Act of 2002 in the assessment of the emerging growth company’s internal control over financial reporting. The JOBS Act also provides that an emerging growth company does not need to comply with any new or revised financial accounting standards until such date that a private company is otherwise required to comply with such new or revised accounting standards. Pursuant to the JOBS Act, we have elected to take advantage of the benefits of this extended transition period for complying with new or revised accounting standards. As a result, our operating results and financial statements may not be comparable to the operating results and financial statements of other companies who have adopted the new or revised accounting standards.

We will remain an emerging growth company until the earliest of (a) the last day of the fiscal year during which we have total annual gross revenues of at least US\$1.07 billion; (b) the last day of our fiscal year following the fifth anniversary of the completion of this offering; (c) the date on which we have, during the preceding three-year period, issued more than US\$1.0 billion in non-convertible debt; or (d) the date on which we are deemed to be a “large accelerated filer” under the Securities Exchange Act of 1934, as amended, or the Exchange Act, which would occur if the market value of the ADSs that are held by non-affiliates exceeds US\$700 million as of the last business day of our most recently completed second fiscal quarter. Once we cease to be an emerging growth company, we will not be entitled to the exemptions provided in the JOBS Act discussed above.

#### **Implication of Being a Foreign Private Issuer**

We are also considered a “foreign private issuer.” Accordingly, upon consummation of this offering, we will report under the Exchange Act as a non-U.S. company with foreign private issuer status. This means

that, even after we no longer qualify as an emerging growth company, as long as we qualify as a foreign private issuer under the Exchange Act, we will be exempt from certain provisions of the Exchange Act that are applicable to U.S. domestic public companies, including:

- the sections of the Exchange Act regulating the solicitation of proxies, consents or authorizations in respect of a security registered under the Exchange Act;
- the sections of the Exchange Act requiring insiders to file public reports of their stock ownership and trading activities and liability for insiders who profit from trades made in a short period of time; and
- the rules under the Exchange Act requiring the filing with the SEC of quarterly reports on Form 10-Q containing unaudited financial and other specified information, or current reports on Form 8-K, upon the occurrence of specified significant events.

We may take advantage of these exemptions until such time as we are no longer a foreign private issuer. We would cease to be a foreign private issuer at such time as more than 50% of our outstanding voting securities are held by U.S. residents and any of the following three circumstances applies: (i) the majority of our executive officers or directors are U.S. citizens or residents, (ii) more than 50% of our assets are located in the United States or (iii) our business is administered principally in the United States.

In this prospectus, we have taken advantage of certain of the reduced reporting requirements as a result of being an emerging growth company and a foreign private issuer. Accordingly, the information contained herein may be different than the information you receive from other public companies in which you hold equity securities.

#### **Implications of being a Controlled Company**

We are a “controlled company” as defined under the Nasdaq Stock Market Rules, because one of our shareholders holds more than 50% of our voting power. As a result, for so long as we remain a controlled company as defined under that rule, we are exempt from, and our shareholders generally are not provided with the benefits of, some of the Nasdaq Stock Market corporate governance requirements, including that:

- a majority of our board of directors must be independent directors;
- our compensation committee must be composed entirely of independent directors; and
- our corporate governance and nomination committee must be composed entirely of independent directors.

Although we intend to reconstitute our board of directors and to have a majority of independent directors, that may change in the future.

#### **Corporate Information**

Belite Bio, Inc was incorporated in the Cayman Islands on March 27, 2018 as an exempted company with limited liability. The address of our registered office in Cayman Islands is located at the Office of Maples Corporate Services Limited, PO Box 309, Ugland House, Grand Cayman, KY1-1104, Cayman Islands. Our principal executive offices are located at 5820 Oberlin Drive, Suite 101, San Diego, CA 92121. Our telephone number at that address is +1-858-246-6240.

Our website address is belitebio.com. Our website and the information contained on our website do not constitute a part of this prospectus. Our agent for service of process in the United States is Puglisi & Associates, located at 850 Library Avenue, Suite 204, Newark, Delaware 19711.

#### **Conventions that Apply to this Prospectus**

Unless otherwise indicated or the context otherwise requires, references in this prospectus to:

- “ADRs” are to the American depositary receipts that may evidence the ADSs;
- “ADSs” are to the American depositary shares, each of which represents one ordinary share;
- “AUD” are to the legal currency of Australia;

- “Belite,” “we,” “us,” “our company,” and “our” are to Belite Bio, Inc, our Cayman Islands holding company and its subsidiaries;
- “China” or the “PRC” are to the People’s Republic of China, excluding, for the purposes of this prospectus only, Hong Kong, Macau and Taiwan;
- “shares” or “ordinary shares” are to our ordinary shares, par value US\$0.0001 per share; and
- “US\$,” “U.S. dollars,” “\$,” and “dollars” are to the legal currency of the United States.

Unless the context indicates otherwise, all information in this prospectus assumes no exercise by the underwriters of their option to purchase additional ADSs from us. The functional currency of the Company’s subsidiaries located in the United States is U.S. dollars. The functional currency of the Company’s subsidiary located in Australia is AUD. Unless otherwise noted, all translations from AUD to U.S. dollars and from U.S. dollars to AUD in this prospectus are made at a rate of \_\_\_\_\_ to US\$1.00, the exchange rate in effect as of \_\_\_\_\_ as set forth in the H.10 statistical release of The Board of Governors of the Federal Reserve System. We make no representation that any AUD or U.S. dollar amounts could have been, or could be, converted into U.S. dollars or AUD, as the case may be, at any particular rate, or at all.



	<p>of the net proceeds for further clinical development of LBS-008 for dry AMD, such as Phase 2 or Phase 3 clinical trials, and the remainder for working capital and other general corporate purposes. See “Use of Proceeds” for more information.</p>
Lock-up	<p>We and each of our officers, directors and shareholders beneficially holding greater than 5% of our ordinary shares have agreed with the underwriters, subject to certain exceptions, not to sell, transfer or otherwise dispose of any ADSs, ordinary shares or similar securities for a period of 180 days after the date of this prospectus. We have also agreed, subject to certain exceptions, not to file or cause to be filed any registration statement relating to the offering of any of our share capital for a period of 180 days after the date of this prospectus. See “Shares Eligible for Future Sale” and “Underwriting” for more information.</p>
Listing	<p>We have applied to have the ADSs listed on the Nasdaq Capital Market under the symbol “BLTE.” The ADSs and our ordinary shares will not be listed on any other stock exchange or traded on any automated quotation system.</p>
Payment and settlement	<p>The underwriters expect to deliver the ADSs against payment therefor through the facilities of the Depository Trust Company on _____, 2022.</p>
Depository	<p>Deutsche Bank Trust Company Americas</p>
Indications of Interest	<p>Lin Bioscience International Ltd., our principal shareholder, has indicated an interest to purchase up to US\$15.0 million of ADSs in this offering, which will represent no more than 50% of the total ADSs in this offering such that we still meet the un-affiliated float listing criteria of the Nasdaq Capital Market. Because indications of interest are not binding agreements or commitments to purchase, Lin Bioscience International Ltd. may determine to purchase fewer ADSs than it has indicated an interest in purchasing or not to purchase any ADSs in this offering.</p>

### SUMMARY CONSOLIDATED FINANCIAL DATA

The following summary consolidated statement of operations and comprehensive loss data for the years ended December 31, 2020 and 2021 and summary consolidated balance sheet data as of December 31, 2020 and December 31, 2021 have been derived from our audited consolidated financial statements included elsewhere in this prospectus. Our consolidated financial statements are prepared and presented in accordance with accounting principles generally accepted in the United States, or U.S. GAAP. Our historical results are not necessarily indicative of results expected for future periods. You should read this Summary Consolidated Financial Data section together with our consolidated financial statements and the related notes and “Management’s Discussion and Analysis of Financial Condition and Results of Operations” included elsewhere in this prospectus.

	For the Years Ended December 31,	
	2020	2021
	(amounts in \$ and in thousands, except for shares and per share data)	
<b>Expenses</b>		
Research and development	3,688	7,419
General and administrative	2,055	2,378
Total operating expenses	5,743	9,797
<b>Loss from operations</b>	<b>(5,743)</b>	<b>(9,797)</b>
<b>Other income (expense):</b>		
Interest income	12	5
Interest expense	(21)	—
Other income	—	126
Total other (expense) income, net	(9)	131
<b>Loss before income tax</b>	<b>(5,752)</b>	<b>(9,666)</b>
Income tax expense	(1)	—
<b>Net loss</b>	<b>(5,753)</b>	<b>(9,666)</b>
<b>Other comprehensive income (loss)</b>		
Foreign currency translation adjustments, net of nil tax	6	(152)
<b>Total comprehensive loss</b>	<b>\$ (5,747)</b>	<b>\$ (9,818)</b>
<b>Weighted average number of ordinary shares used in per share calculation:</b>		
—Basic and Diluted	8,790,397	9,569,932
<b>Net loss per ordinary share</b>		
—Basic and Diluted	\$ (0.65)	\$ (1.01)

	As of December 31, 2020	As of December 31, 2021
	(amounts in \$ and in thousands)	
<b>Selected Consolidated Balance Sheets Data:</b>		
Cash	\$25,618	\$ 17,344
Total assets	\$25,741	\$ 18,348
Total liabilities	\$ 972	\$ 1,635
Total convertible preferred shares	\$31,806	\$ 31,806
Total shareholders' deficit	\$ (7,037)	\$ (15,093)
Total liabilities, convertible preferred shares and shareholders' deficit	\$25,741	\$ 18,348



## RISK FACTORS

*Investing in our ADSs involves a high degree of risk. You should carefully consider the following risks and uncertainties and all other information contained in this prospectus before investing in our ADSs. Our business, financial condition, results of operations or prospects could also be harmed by risks and uncertainties not currently known to us or that we currently do not believe are material. If any of the risks actually occur, our business, financial condition, results of operations and prospects could be adversely affected. In that event, the market price of our ADSs could decline, and you could lose part or all of your investment.*

### Risks Related to the Discovery, Development and Commercialization of Our Product Candidates

***Our business is highly dependent on the success of our lead product candidate, LBS-008. If we are unable to develop, obtain marketing approval for or successfully commercialize LBS-008, either alone or through a collaboration, or if we experience significant delays in doing so, our business could be harmed.***

We currently have no products that are approved for commercial sale and may never be able to develop marketable products. Our business and future success depends in large part on our ability to develop, obtain regulatory approval for, and then successfully commercialize our lead product candidate, LBS-008. This may make an investment in our company riskier than similar companies that have multiple product candidates in active late-stage development that may be able to better sustain the failure of a lead product candidate.

Further, if LBS-008 does not obtain approval for the treatment of autosomal recessive Stargardt disease (STGD1), which is the initial indication that we are currently exploring, we will have spent substantial time and financial resources without receiving a return on investment. As a result, if LBS-008 does not receive approval or fails to become profitable and receive market acceptance, our business, results of operations and financial condition will be adversely affected.

The success of LBS-008 will depend on several factors, including the following:

- successful completion of our ongoing clinical trials;
- initiation and successful enrollment and completion of additional clinical trials;
- safety, tolerability and efficacy profiles that are satisfactory to the U.S. Food and Drug Administration, or the FDA, , the Therapeutic Goods Administration of Australia, or the TGA, National Medical Products Administration, or the NMPA (formerly known as the China Food and Drug Administration, or the CFDA), the European Medicines Agency, or the EMA or any comparable foreign regulatory authority for marketing approval;
- timely receipt of marketing approvals from applicable regulatory authorities;
- the performance of our future collaborators, if any;
- the extent of any required post-marketing approval commitments to applicable regulatory authorities;
- establishment of supply arrangements with third-party raw materials suppliers and manufacturers;
- establishment of arrangements with third-party manufacturers to obtain finished products that are appropriately packaged for sale;
- obtaining and maintaining patent, trade secret protection and regulatory exclusivity, both in the United States and internationally;
- protection of our rights in our intellectual property portfolio;
- successful launch of commercial sales following any marketing approval;
- a continued acceptable safety profile following any marketing approval, and meeting all applicable postmarket commitments, obligations, and requirements;
- commercial acceptance of our products, if approved, by patients, the medical community and third-party payors; and
- our ability to compete with other therapies.

If we do not achieve one or more of these factors, many of which are beyond our control, in a timely manner or at all, we could experience significant delays or an inability to obtain regulatory approvals or commercialize LBS-008. Even if regulatory approvals are obtained, we may never be able to successfully commercialize LBS-008. Accordingly, we may not be able to generate sufficient revenue through the sale of LBS-008 to continue our business.

***We may allocate our limited resources to pursue a particular product candidate, indication, including any additional indications for LBS-008, or technology and fail to capitalize on existing or future product candidates, indications or technologies that may later prove to be more profitable, or for which there is a greater likelihood of success.***

Because we have limited financial and managerial resources, we intend to focus on developing product candidates for specific indications that we identify as most likely to succeed, in terms of both their potential for marketing approval and commercialization. As a result, we may forgo or delay pursuit of opportunities with other product candidates or for other indications or technologies that later may prove to have greater commercial potential or a greater likelihood of success. Our resource allocation decisions may cause us to fail to capitalize on viable commercial products or profitable market opportunities. Our spending on current and future research and development programs and product candidates for specific indications may not yield any commercially viable product candidates. In addition, if we do not accurately evaluate the commercial potential or target market for a particular product candidate or technology, we may relinquish valuable rights to that product candidate or technology through collaboration, licensing or other royalty arrangements when it would have been more advantageous for us to retain sole development and commercialization rights to such product candidate or technology. For example, we are developing our lead product candidate, LBS-008, to initially treat STGD1. We are also considering a number of additional indications for LBS-008, including the treatment of nonalcoholic steatohepatitis. We cannot guarantee that the treatment of STGD1 will be the most profitable indication for LBS-008 as opposed to other contemplated indications. This could result in us failing to capitalize on the true market potential of our lead product candidate in a timely manner or at all.

Although a substantial amount of our efforts will focus on the continued clinical testing, potential approval, manufacturing and commercialization of our existing product candidates, the success of our business depends in part upon our ability to identify, license, discover, develop, or commercialize additional product candidates or new technologies. Research efforts to identify new product candidates and technologies require substantial technical, financial, and human resources. Although we do not currently engage in such activities, we may in the future seek to expand our drug pipeline through in-licensing arrangements. We may end up focusing our efforts and resources on potential product candidates and technologies that ultimately prove to be unsuccessful. Our research and any future licensing efforts may fail to identify, discover or in-license new product candidates and technologies suitable for clinical development and commercialization for a number of reasons, including, but not limited to, the following:

- our research or business development methodology or search criteria and process may be unsuccessful in identifying potential product candidates and technologies, or potential product candidates and technologies that are within our resources to license or acquire and develop;
- our potential product candidates and technologies may be shown to have adverse effects or may have other characteristics that may make the products unmarketable or unlikely to receive marketing approval; and
- it may take greater human, financial and/or research resources to identify additional therapeutic opportunities for our product candidates or to develop more suitable potential product candidates and technologies than what we possess, thereby limiting our ability to diversify and expand our drug portfolio.

Accordingly, there can be no assurance that we will successfully identify and develop new product candidates or technologies, or additional therapeutic opportunities for our product candidates, whether through internal research or future licensing efforts, which could materially adversely affect our future growth and prospects.

***Clinical development involves a lengthy and expensive process with an uncertain outcome, and results of earlier studies may not be predictive of future study results.***

There is a risk of failure for every product candidate. Clinical testing is expensive, is difficult to design and implement and can take many years to complete, and its outcome is inherently uncertain. It is difficult to predict when or if any of our product candidates will prove effective and safe in humans or will receive regulatory approval, and failure can occur at any time during the preclinical and clinical development process. Before obtaining regulatory approval from regulatory authorities for the sale of any product candidate, our product candidates must complete preclinical studies and then conduct extensive clinical trials to demonstrate the safety and efficacy of our product candidates in humans.

The results of preclinical studies and clinical trials of our product candidates may not be predictive of the results of later-stage clinical trials. Product candidates during later stages of clinical trials may fail to show the desired results in safety and efficacy despite having progressed through preclinical studies and initial to advanced clinical trials and despite the level of scientific rigor in the study, design and adequacy of execution. In some instances, there can be significant variability in safety and/or efficacy results among different studies of the same product candidate due to numerous factors, including, but not limited to, differences in individual patient conditions, including genetic differences, and other compounding factors, such as other medications or pre-existing medical conditions. Many product candidates in the biopharmaceutical industry have suffered significant setbacks in advanced clinical trials due to a lack of efficacy or adverse safety profiles, notwithstanding promising results in earlier studies. Moreover, preclinical and clinical data are often susceptible to varying interpretations and analyses, and many companies that have believed their product candidates performed satisfactorily in preclinical studies and clinical trials have nonetheless failed to obtain regulatory approval of their product candidates.

In the case of any studies we conduct, results may differ from earlier studies due to the larger number of clinical trial sites and additional countries and languages involved in such studies. Clinical practices vary globally, and there is a lack of harmonization among the guidance provided by various regulatory bodies of different regions and countries with respect to the data that is required to receive marketing approval, which makes designing global studies increasingly complex. Differing regulatory approval requirements in different countries could make it more difficult for us to conduct unified global studies, which can lead to increased development costs and marketing delays or non-viability of our clinical trials. In addition, the FDA may determine that clinical trial results obtained in foreign subjects do not adequately represent the results that would be obtained in U.S. patients and are thus not supportive of an NDA approval in the United States.

In particular, if we experience delays in the start or completion of, or termination of, any clinical trial of LBS-008, the commercial prospects of LBS-008 may be harmed, and our ability to generate product revenues from LBS-008 will be delayed. In addition, any delays in completing our clinical trials will increase our costs, slow down the development and approval process for LBS-008, and jeopardize our ability to commence product sales and generate revenues. Any of these occurrences may significantly harm our business, financial condition and prospects. In addition, many of the factors that cause, or lead to, a delay in the commencement or completion of clinical trials may also ultimately lead to the denial of regulatory approval of LBS-008.

***All of our product candidates are in preclinical or clinical development. If we are unable to complete clinical development and obtain regulatory approval to ultimately commercialize our product candidates, or if we experience significant delays in doing so, our business, financial condition, results of operations and prospects will be materially harmed.***

All of our product candidates are still in development. Our ability to generate revenue from our product candidates is dependent on receipt of regulatory approval and successful commercialization of such products. We cannot guarantee that we will be able to obtain regulatory approvals for our existing product candidates in a timely manner, or at all, and we may be unable to obtain successful commercialization of our product candidates even if we receive regulatory approval. Each of our product candidates will require additional preclinical and/or clinical development, regulatory approvals in multiple jurisdictions, development of commercial manufacturing supply and capacity, substantial investment and significant marketing efforts before we generate any revenue from product sales.

The success of our product candidates will depend on several factors, including, but not limited to, the following:

- hiring sufficient technical experts to oversee all development and regulatory activities and meeting of safety requirements;
- successful completion of preclinical studies and clinical trials, including the successful enrollment in such clinical trials;
- receipt of regulatory approvals from applicable regulatory authorities for planned and future clinical trials, drug registration, manufacturing and commercialization;
- successful completion of all safety studies required to obtain regulatory approval in United States, Australia, Taiwan, China, the Europe and other applicable jurisdictions for our product candidates;
- our ability to establish manufacturing capabilities and capacities, whether internally or through CMOs, to the specifications of our product candidates for clinical supply;
- obtaining and maintaining patent, trade secret and other intellectual property protection and/or regulatory exclusivity for our product candidates;
- launching commercial sales of our product candidates, if and when approved, whether alone or in collaboration with others;
- acceptance of the product candidates, if and when approved, by patients, the medical community and third-party payors;
- obtaining and maintaining healthcare coverage and adequate reimbursement;
- effectively competing with other therapies and alternative drugs;
- successfully enforcing and defending intellectual property rights and claims; and
- maintaining a continued acceptable safety profile of the product candidates following regulatory approval, and meeting all applicable postmarket commitments, obligations, and requirements.

Any significant delays in, or an inability to, obtain regulatory approval and ultimately achieve commercial success for our existing and future product candidates in one or more jurisdictions would materially harm our business and we may not be able to generate enough revenues and cash flows to continue our operations, including delays due to COVID-19 could further materially harm our business. As a result, our financial condition, results of operations and prospects will be materially and adversely harmed.

***If we encounter delays or difficulties enrolling and retaining patients in our clinical trials, our clinical development progress and our receipt of necessary regulatory approvals could be delayed or otherwise adversely affected.***

The timely completion of clinical trials in accordance with their protocols depends, among other things, on our ability to enroll a sufficient number of patients that will remain in the study until its conclusion. We may not be able to initiate or continue clinical trials for our product candidates if we are unable to locate and enroll a sufficient number of eligible patients to participate in these studies as required by the FDA, the TGA, the NMPA, the EMA and any other applicable similar regulatory authorities, or if there are delays in the enrollment of eligible patients as a result of the competitive clinical enrollment environment. Even once enrolled, we may be unable to retain a sufficient number of patients to complete any of our trials. The inability to enroll a sufficient number of patients who meet the applicable criteria for our clinical trials would result in significant delays and could require us to abandon one or more clinical trials altogether. If patients are unwilling to enroll in our clinical trials because of the COVID-19 pandemic and restrictions on travel or healthcare institution policies, negative publicity from adverse events related to the biopharmaceutical industry or for other reasons, the timeline for recruiting patients, conducting studies and obtaining regulatory approval of our product candidates may be delayed. Even if we are able to enroll a sufficient number of patients in our clinical trials, delays in patient enrollment could result in increased development costs, delays in advancing our product candidates, delays in testing the effectiveness of our product candidates or termination of clinical trials altogether.

Patient enrollment for our clinical trials may be affected by other factors, including, but not limited to, the following:

- severity of the disease under investigation;
- total size and nature of the relevant patient population;
- design and eligibility criteria for the clinical trial in question, including age-based eligibility criteria limiting subject enrollment to adolescent populations;
- perceived risks and benefits of the product candidate under study;
- our resources to facilitate timely enrollment in clinical trials;
- patient referral practices of physicians;
- availability of competing therapies also undergoing clinical trials;
- our investigators' or clinical trial sites' efforts to screen and recruit eligible patients;
- our ability to maintain patient consents;
- ability to monitor patients adequately during and after treatment;
- proximity and availability of clinical trial sites for prospective patients; and
- the occurrence of any pandemic, epidemic or any other public health crises, including from the COVID-19 pandemic, natural catastrophe or other disasters that may cause a delay in enrollment of patients in clinical trials.

Additionally, our ability to successfully initiate, enroll and complete clinical trials in any foreign country is subject to numerous risks unique to conducting business in foreign countries, including:

- difficulty in establishing or managing relationships with contract research organizations, or CROs, and physicians;
- different standards for the conduct of clinical trials;
- absence in some countries of established groups with sufficient regulatory expertise for review of protocols;
- inability to locate qualified local consultants, physicians and partners; and
- the potential burden of complying with a variety of foreign laws, medical standards and regulatory requirements.

In addition, our clinical trials may compete with other clinical trials for drug candidates that are in the same therapeutic areas as our drug candidates, and this competition will reduce the number and types of patients available to us, because some patients who might have opted to enroll in our trials may instead opt to enroll in a trial being conducted by one of our competitors. Because the number of qualified clinical investigators and clinical trial sites is limited, we expect to conduct some of our clinical trials at the same clinical trial sites that some of our competitors use, which will reduce the number of patients who are available for our clinical trials at such clinical trial sites. For example, we have experienced delays in the enrollment of patients in our clinical trials due to government orders and site policies on account of the COVID-19 pandemic, and some patients may be unwilling or unable to travel to study sites, enroll in our studies or comply with clinical trial protocols if quarantines impede patient movement or interrupt healthcare services. If we have difficulty enrolling a sufficient number of patients or finding additional clinical trial sites to conduct our clinical trials as planned, we may need to delay, limit or terminate ongoing or planned clinical trials, any of which could have an adverse effect on our business, financial condition, results of operations and prospects. In addition, it is possible that the COVID-19 pandemic may have an impact on the workforce of the third parties and CROs on which we rely, which could adversely impact our ability to conduct preclinical studies, enroll and retain patients in our clinical trials and conduct the clinical trials of our product candidates on expected timeframes or to complete such studies, and our ability to ultimately obtain regulatory approval. As a result, the value of our Company could decline and our ability to obtain additional financing may be impaired.

***If clinical trials of our product candidates fail to demonstrate safety and efficacy to the satisfaction of regulatory authorities or do not otherwise produce positive results, we may incur additional costs or experience delays in completing, or ultimately be unable to complete, the development and commercialization of our product candidates.***

Before obtaining regulatory approval for the sale of our product candidates, we must conduct extensive clinical trials to demonstrate the safety and efficacy of our product candidates in humans. We may experience numerous unexpected events during, or as a result of, clinical trials that could delay or prevent our ability to receive regulatory approval or commercialize our product candidates, including, but not limited to, the following:

- regulators, institutional review boards, or IRBs, or ethics committees may not authorize us or our investigators to commence a clinical trial or conduct a clinical trial at a prospective study site;
- delay in reaching, or failure to reach, agreements on acceptable terms with prospective CROs and study sites, the terms of which can be subject to extensive negotiation and may vary significantly among different CROs and study sites;
- manufacturing issues, including problems with manufacturing, supply quality, compliance with current good manufacturing practices, or cGMP, or obtaining sufficient quantities of a product candidate from third parties for use in a clinical trial;
- clinical trials of our product candidates may produce negative or inconclusive results, and we may decide to conduct additional clinical trials or abandon the development of such product candidates, or regulators may require us to do so;
- the number of patients required for clinical trials of our product candidates may be larger than we anticipate, enrollment may be insufficient or slower than we anticipate, or patients may drop out or fail to return for post-treatment follow-up at a higher rate than we anticipate;
- our third-party contractors used in our clinical trials, including any clinical investigators, may fail to comply with regulatory requirements or meet their contractual obligations to us in a timely manner, or at all, or may deviate from clinical trial protocol or dropout of clinical trials, which may require that we add new clinical trial sites or clinical investigators;
- we might have to suspend or terminate clinical trials of our product candidates for various reasons, including a finding of a lack of clinical response, serious adverse, undesirable or unacceptable side effects or other unexpected characteristics or a finding that participants are being exposed to unacceptable health risks;
- we may elect to, or regulators, IRBs or ethics committees may require that we or our investigators, suspend or terminate clinical research or not rely on the results of clinical research for various reasons, including non-compliance with regulatory requirements;
- the cost of clinical trials of our product candidates may be greater than we anticipate; and
- the supply or quality of our product candidates or other materials necessary to conduct clinical trials of our product candidates may be insufficient or inadequate.

If we are required to conduct additional clinical trials or other testing of our product candidates beyond those that we currently plan, if we are unable to successfully complete clinical trials of our product candidates or other testing, if the results of these studies or tests are not positive or are only modestly positive or if they raise safety concerns, we may (i) be delayed in obtaining regulatory approval for our product candidates; (ii) obtain approval for indications or patient populations that are not as broad as intended or desired; (iii) not obtain regulatory approval at all; (iv) have the drug removed from the market after obtaining regulatory approval; (v) be subject to additional post-marketing testing requirements; (vi) be subject to restrictions on how the drug is distributed or used; or (vii) be unable to obtain reimbursement for use of the drug. Many of the factors that cause a delay in the commencement or completion of clinical trials may also ultimately lead to the denial of regulatory approval of our product candidates. Further, the FDA, the TGA, the NMPA, the EMA or other regulatory authorities may disagree with our clinical trial design or our interpretation of data from clinical trials, or may change the requirements for approval even after it has reviewed and commented on the design for our clinical trials.

***Our clinical trials are conducted in multiple jurisdictions, which may subject us to delays and expenses.***

We are currently conducting clinical trials, through third-party CROs, in Australia and Taiwan and expect to further expand into other jurisdictions (see “Business” beginning on page 112 for our current plans for future clinical trials). There are risks inherent in conducting clinical trials in multiple jurisdictions, which may subject us to delays and expenses, such as:

- regulatory and administrative requirements of the jurisdiction where the study is conducted that could burden or limit our ability to conduct clinical trials;
- differing and conflicting regulatory requirements;
- foreign exchange fluctuations;
- manufacturing, customs, shipment and storage requirements;
- cultural differences in medical practice and clinical research; and
- the risk that the patient populations in such trials are not considered representative as compared to the patient population in the target markets where approval is being sought.

***Our product candidates may cause serious adverse, undesirable or unacceptable side effects or have other properties that could delay or prevent their regulatory approval, limit the commercial profile of an approved label, and/or result in significant negative consequences following regulatory approval, if any.***

As is the case with pharmaceuticals generally, it is likely that there may be serious adverse, undesirable or unacceptable side effects caused by our product candidates that could cause us or regulatory authorities to interrupt, delay or halt clinical trials and may result in a more restrictive label, a delay or denial of regulatory approval by the FDA, the TGA, the NMPA, the EMA or other comparable regulatory authorities, or a significant change in our clinical protocol or even our development plan. Results of our future preclinical studies and clinical trials could reveal a high and unacceptable severity or prevalence of steroidal adverse events. In such an event, our studies could be suspended or terminated and the FDA, the TGA, the NMPA, the EMA or other comparable regulatory authorities could order us to cease further development of, or deny approval of, our product candidates for any or all targeted indications. Adverse events related to our product candidates may affect patient recruitment or the ability of enrolled subjects to complete the study and could result in potential liability claims. Any of these occurrences may significantly harm our reputation, business, financial condition and prospects.

Additionally, the identification of serious adverse, undesirable or unacceptable side effects caused by any of our future approved product candidates may lead to potentially significant negative consequences, which include, but are not limited to, the following:

- suspension of our marketing of the product candidate;
- withdrawal or revocation by regulatory authorities of their approvals of or the licenses for the product candidate;
- the requirement by regulatory authorities to conduct additional clinical trials, add additional warnings to, or otherwise change, the label of the product candidate, such as a “black box” warning or contraindication, or create a medication guide outlining the risks of such side effects for distribution to patients;
- restriction on the distribution of the product candidate or imposition of burdensome implementation requirements on us through the establishment of a Risk Evaluation and Mitigation Strategy, or REMS, or similar strategy as may be required by the FDA, the TGA, the NMPA, the EMA or a comparable regulatory authority;
- the requirement by regulatory authorities to conduct specific post-marketing studies of the product candidate;
- the requirement to change the way the product candidate is distributed or administered;
- becoming subjected to regulatory investigations, government enforcement actions or litigation proceedings, and being held liable for harm caused to subjects or patients;

- the product becoming less competitive;
- removal of product candidates from the marketplace; and
- harm to our reputation.

Any of these events could prevent us from achieving or maintaining market acceptance of any particular product candidate that is approved and could significantly harm our business, results of operations and prospects.

Further, the use of our product candidates in conjunction with other therapies, may result in unique adverse events that could be exacerbated compared with adverse events from the use of our product candidates alone. Results of our studies could reveal a high and unacceptable severity or prevalence of adverse events. These types of adverse events could be caused by our product candidates and could cause us or regulatory authorities to interrupt, delay or halt clinical trials and may result in a more restrictive indication or the delay or denial of regulatory approval by the FDA, the TGA, the NMPA, the EMA or other comparable regulatory authority.

***Results of preclinical studies and earlier clinical trials may not be predictive of results of future clinical trials.***

The outcome of preclinical studies and earlier clinical trials may not be predictive of the success of later clinical trials, and interim results of clinical trials do not necessarily predict success in future clinical trials. Many companies in the pharmaceutical and biotechnology industries have suffered significant setbacks in late-stage clinical trials after achieving positive results in earlier development, and we could face similar setbacks. The design of a clinical trial can determine whether its results will support approval of a product and flaws in the design of a clinical trial may not become apparent until the clinical trial is well advanced. We have limited experience in designing clinical trials and may be unable to design and execute a clinical trial to support marketing approval. In addition, preclinical and clinical data are often susceptible to varying interpretations and analyses. Many companies that believed their product candidates performed satisfactorily in preclinical studies and clinical trials have nonetheless failed to obtain marketing approval for the product candidates. Even if we, or any future collaborators, believe that the results of clinical trials for our product candidates warrant marketing approval, the FDA, the TGA, the NMPA, the EMA or other comparable regulatory authority may disagree and may not grant marketing approval of our product candidates.

In some instances, there can be significant variability in safety or efficacy results between different clinical trials of the same product candidate due to numerous factors, including changes in trial procedures set forth in protocols, differences in the size and type of the patient populations, changes in and adherence to the dosing regimen and other clinical trial protocols and the rate of dropout among clinical trial participants. If we fail to receive positive results in clinical trials of our product candidates, the development timeline and regulatory approval and commercialization prospects for our most advanced product candidates, and, correspondingly, our business and financial prospects would be negatively impacted.

***The manufacture of biopharmaceutical products is a complex process which requires significant expertise and capital investment, and if we encounter problems in establishing our manufacturing capabilities for clinical or commercial scale or in the manufacture of our future products, our business could suffer.***

We currently do not have cGMP manufacturing capabilities and we are entirely dependent on third-party contractors to manufacture our product candidates for our clinical trials. The manufacture of biopharmaceutical products is a complex process, in part due to strict regulatory requirements. If we are unable to identify an appropriate production site or a suitable collaborator to develop our manufacturing infrastructure, or fail to do so in a timely manner, this may lead to significant delays in the clinical supply of our product candidates as well as the commercial manufacturing of our product candidates once regulatory and marketing approvals have been obtained. In turn, this could delay our clinical trials, negatively impact our ability to ultimately obtain regulatory approval and materially harm any future commercialization plans.

In addition, problems may arise during the manufacturing process for a variety of reasons, including, but not limited to, equipment malfunction, failure to follow specific protocols and procedures, problems with (including shortage of) raw materials, global supply chain issues, delays related to the construction of new facilities or expansion of any future manufacturing facilities, including changes in manufacturing



production sites and limits to manufacturing capacity due to regulatory requirements, changes in the types of products produced, increases in the prices of raw materials, physical limitations that could inhibit continuous supply, man-made or natural disasters and environmental factors. For example, although we have not experienced material supply disruptions due to the COVID-19 pandemic, we cannot guarantee that we will not experience supply disruptions in the future due to COVID-19 or any other pandemic, epidemic or other public health crises, natural catastrophe or other disasters. If problems arise during the production of a batch of future products, that batch of future products may have to be discarded and we may experience product shortages or incur added expenses. This, as well as problems that may arise during the manufacturing process, could, among other things, lead to significant additional costs and/or delays, lost revenue, damage to customer relationships, time and expense spent investigating the cause and, depending on the cause, similar losses with respect to other batches or products. If problems are not discovered before such product is released to the market, recall and product liability costs may also be incurred.

***We have never obtained marketing approval for a product candidate and we may be unable to obtain, or may be delayed in obtaining, marketing approval for any of our product candidates.***

We have never obtained marketing approval for a product candidate. It is possible that the FDA, the TGA, the NMPA, the EMA or other comparable regulatory authority may refuse to accept for substantive review any NDAs that we submit for our product candidates or may conclude after review of our data that our application is insufficient to obtain marketing approval of our product candidates. If the FDA, the TGA, the NMPA, the EMA or other comparable regulatory authority does not accept or approve our NDAs for any of our product candidates, it may require that we conduct additional clinical trials, preclinical studies or manufacturing validation studies and submit that data before it will reconsider our applications. Depending on the extent of these or any other required trials or studies, approval of any NDA or application that we submit may be delayed by several years, or may require us to expend more resources than we have available. It is also possible that additional trials or studies, if performed and completed, may not be considered sufficient by the FDA, the TGA, the NMPA, the EMA or other comparable regulatory authority to approve our NDAs.

Any delay in obtaining, or an inability to obtain, marketing approvals would prevent us from commercializing our product candidates, generating revenues and achieving and sustaining profitability. If any of these outcomes occur, we may be forced to abandon our development efforts for our product candidates, which could significantly harm our business.

***Even if any of our product candidates receives marketing approval, we or others may later discover that the product is less effective than previously believed or causes undesirable side effects that were not previously identified, which could compromise our ability, or that of any future collaborators, to market the product.***

Clinical trials of our product candidates are conducted in carefully defined sets of patients who have agreed to enter into clinical trials. Consequently, it is possible that our clinical trials, or those of any future collaborator, may indicate an apparent positive effect of a product candidate that is greater than the actual positive effect, if any, or alternatively fail to identify undesirable side effects. If, following approval of a product candidate, we, or others, discover that the product is less effective than previously believed or causes undesirable side effects that were not previously identified, any of the following adverse events could occur:

- regulatory authorities may withdraw their approval of the product or seize the product;
- we, or any future collaborators, may be required to recall the product, change the way the product is administered or conduct additional clinical trials;
- additional restrictions may be imposed on the marketing of, or the manufacturing processes for, the particular product;
- we may be subject to fines, injunctions or the imposition of civil or criminal penalties;
- regulatory authorities may require the addition of labeling statements, such as a “black box” warning or a contraindication;

- we, or any future collaborators, may be required to create a Medication Guide outlining the risks of the previously unidentified side effects for distribution to patients;
- we, or any future collaborators, could be sued and held liable for harm caused to patients;
- the product may become less competitive; and
- our reputation may suffer.

Any of these events could harm our business and operations, and could negatively impact our price of our ADS.

***Our product candidates may fail to achieve the degree of market acceptance by physicians, patients, patient advocacy groups, third-party payors and others in the medical community necessary for commercial success.***

Even if our product candidates receive regulatory approval, they may nonetheless fail to gain sufficient market acceptance by physicians, patients, patient advocacy groups and others in the medical community. Efforts to educate physicians, patients, patient advocacy groups and third-party payors on the benefits of our product candidates may require significant resources and may not be successful, and physicians and patients may prefer other drugs or product candidates to ours. If our product candidates do not achieve an adequate level of acceptance, we may not generate significant revenue from sales of our drugs or product candidates and may not become profitable.

The degree of market acceptance of our product candidates, if and only when they are approved for commercial sale, will depend on a number of factors, including, but not limited to, the following:

- the clinical indications for which our product candidates are approved;
- the degree to which physicians, hospitals, patient advocacy groups and patients consider our product candidates as safe and effective treatments;
- whether our product candidates have achieved the perceived advantages of our product candidates over alternative treatments;
- the prevalence and severity of any adverse effects;
- product labeling or package insert requirements of the FDA, the TGA, the NMPA, the EMA or other comparable regulatory authorities;
- limitations or warnings contained in the labeling approved by the FDA, the TGA, the NMPA, the EMA or other comparable regulatory authorities;
- timing of market introduction of our product candidates as well as competitive drugs;
- cost of treatment in relation to alternative treatments;
- availability of adequate coverage and reimbursement from third-party payors and government authorities in the United States, Australia, China or any other jurisdictions;
- willingness of patients to pay any out-of-pocket expenses in the absence of coverage and reimbursement by third-party payors and government authorities;
- relative convenience and ease of administration, including as compared with alternative treatments and competitive therapies; and
- the effectiveness of our sales and marketing efforts.

***We face substantial competition, rapid technological change and the possibility that our competitors may discover, develop or commercialize drugs before we do or more successfully than we do, or develop therapies that are similar, more advanced or more effective than ours, each of which may adversely affect our financial condition and our ability to successfully market or commercialize our product candidate.***

The development and commercialization of new drugs is highly competitive and the biopharmaceutical industry is subject to rapid and significant technological change. We face competition with respect to our

product candidates and will face competition with respect to any product candidates that we may seek to develop or commercialize in the future, from companies of all sizes around the world, including major and specialty pharmaceutical companies and generic drug companies. Specifically, some of our competitors have ongoing clinical trials for product candidates that treat the same indications as LBS-008. Potential competitors further include academic institutions, government agencies and other public and private research organizations that conduct research, seek patent protection and establish collaborative arrangements for research, development, manufacturing and commercialization.

Many of our competitors have significantly greater financial, technical, human and other resources, such as larger research and development staff and experienced marketing and manufacturing departments, and more experience in the development and regulatory approval process than we have. Mergers and acquisitions in the biotechnology and pharmaceutical industries may result in even more resources being concentrated in our competitors. As a result, these companies may obtain regulatory approval from the FDA, the TGA, the NMPA, the EMA or other comparable regulatory authorities more rapidly than we are able to and may be more effective in selling and marketing their products as well. For example, the NMPA has recently accelerated market approval of drugs for diseases with high unmet medical need. In particular, the NMPA may review and approve drugs that have gained regulatory market approval in the United States, the European Union or Japan in the recent ten years without requiring further clinical trials in China. This may lead to potential increased competition from drugs that have already obtained approval in other jurisdictions. Smaller or early-stage companies may also prove to be significant competitors, particularly through collaborative arrangements with large, established companies. Our competitors also compete with us in recruiting and retaining qualified scientific and management personnel and establishing clinical trial sites and patient registration for clinical trials, as well as in acquiring technologies complementary to, or necessary for, our drug development programs.

Our competitors may succeed in developing, acquiring, or licensing on an exclusive basis, products that are more effective, safer or less costly than any product candidate that we may develop, or may achieve earlier patent protection, regulatory approval, product commercialization, and market penetration than we do. Additionally, technologies developed by our competitors may render our potential product candidates uneconomical or obsolete, and we may not be successful in marketing our product candidates against competitors. The availability of our competitors' products could limit the demand, and the price we are able to charge, for any product candidates that we may develop and commercialize.

***While certain of our employees have limited experience in launching and marketing product candidates, we may not be able to effectively build and manage a sales network or benefit from the sales network of third-party collaborators.***

We currently have no sales, marketing or commercial product distribution capabilities. Over time, we intend to develop an in-house marketing organization and sales force, which will require significant capital expenditures, management resources and time. We will have to compete with other biopharmaceutical companies to recruit, hire, train and retain marketing and sales personnel.

If we are unable or decide not to establish internal sales, marketing and commercial distribution capabilities for any or all of the drugs we develop or in particular regions or markets, we may pursue collaborative arrangements regarding the sales and marketing of such drugs into such regions or markets. However, there can be no assurance that we will be able to establish or maintain such collaborative arrangements, or, if we are able to do so, that they will have effective sales forces. Any revenue we receive will depend on the efforts of such third parties, which may not be successful. We may have little or no control over the marketing and sales efforts of such third parties, and our revenue from product sales may be lower than if we had commercialized our product candidates ourselves. We will also face competition in our search for third parties to assist us with the sales and marketing efforts of our product candidates, which may result in collaborative arrangements with less than optimal terms.

There can be no assurance that we will be able to develop in-house sales and commercial distribution capabilities or establish or maintain relationships with third-party collaborators to successfully commercialize any product, and as a result, we may not be able to generate product sales revenue.

***Even if we are able to commercialize any approved product candidates, reimbursement may be limited or unavailable in certain market segments for our product candidates, and we may be subject to unfavorable pricing regulations, which could harm our business.***

The regulations that govern regulatory approvals, pricing and reimbursement for new therapeutic products vary widely from country to country. Some countries require approval of the sale price of a drug before it can be marketed. In many countries, the pricing review period begins after marketing or licensing approval is granted. In some non-U.S. markets, prescription pharmaceutical pricing remains subject to continuing governmental control even after initial approval is granted. As a result, we might obtain regulatory approval for a drug in a particular country, but then be subject to price regulations that delay our commercial launch of the drug and negatively impact the revenues we are able to generate from the sale of the drug in that country. Adverse pricing limitations may hinder our ability to recoup our investment in one or more product candidates, even if our product candidates obtain regulatory approval.

Our ability to commercialize any drugs successfully also will depend in part on the extent to which reimbursement for these drugs and related treatments will be available from government health administration authorities, private health insurers and other organizations. Government authorities and third-party payors, such as private health insurers and health maintenance organizations, decide which medications they will pay for and establish reimbursement levels. A primary trend in the global healthcare industry is cost containment. Government authorities and these third-party payors have attempted to control costs by limiting coverage and the amount of reimbursement for particular medications. Increasingly, third-party payors are requiring that companies provide them with predetermined discounts from list prices and are challenging the prices charged for medical products. We cannot be sure that reimbursement will be available for any drug that we commercialize and, if reimbursement is available, what the level of reimbursement will be. Reimbursement may impact the demand for, or the price of, any drug for which we obtain regulatory approval. Obtaining reimbursement for certain of our drugs may be particularly difficult because of the higher prices often associated with drugs administered under the supervision of a physician. If reimbursement is not available or is available only to limited levels, we may not be able to successfully commercialize any product candidate that we successfully develop.

There may be significant delays in obtaining reimbursement for approved product candidates, and coverage may be more limited than the purposes for which the product candidates are approved by the FDA, the TGA, the NMPA, the EMA or other comparable regulatory authorities. Moreover, eligibility for reimbursement does not imply that any drug will be paid for in all cases or at a rate that covers our costs, including research, development, manufacture, sale and distribution. Interim payments for new drugs, if applicable, may also not be sufficient to cover our costs and may not be made permanent. Payment rates may vary according to the use of the drug and the clinical setting in which it is used, may be based on payments allowed for lower cost drugs that are already reimbursed, and may be incorporated into existing payments for other services. Net prices for drugs may be reduced by mandatory discounts or rebates required by government healthcare programs or private payors and by any future weakening of laws that presently restrict imports of drugs from countries where they may be sold at lower prices than in the United States. Our inability to promptly obtain coverage and profitable payment rates from both government-funded and private payors for any future approved product candidates could have a material adverse effect on our business, our operating results, and our overall financial condition.

***Preliminary interim or “top-line” data that we announce or publish from time to time may change as more data become available and are subject to audit and verification procedures that could result in material changes in the final data.***

From time to time, we may publish preliminary interim or “top-line” data from clinical trials. Positive preliminary data from such interim analyses may not be predictive of such trial’s subsequent or overall results. Preliminary data are subject to the risk that one or more of the outcomes may materially change as more data become available. Additionally, preliminary data are subject to the risk that one or more of the clinical outcomes may materially change as patient enrollment continues and more patient data become available. Therefore, positive preliminary results in any ongoing clinical trial may not be predictive of such results in the completed trial. We also make assumptions, estimations, calculations and conclusions as part of our analyses of data, and we may not have received or had the opportunity to fully evaluate all data. As a result,

preliminary data that we report may differ from future results from the same clinical trials, or different conclusions or considerations may qualify such results, once additional data have been received and fully evaluated. Preliminary data also remain subject to audit and verification procedures that may result in the final data being materially different from the preliminary data we previously published. As a result, preliminary data should be viewed with caution until the final data are available. Material adverse changes in the final data compared to preliminary data could significantly harm our business prospects.

***The data and information that we gather in our research and development process could be inaccurate or incomplete, which could harm our business, reputation, financial condition and results of operations.***

We collect, aggregate, process, and analyze data and information from our preclinical studies and clinical trials. We also engage in substantial information gathering following the identification of a promising product candidate. Because data in the healthcare industry is fragmented in origin, inconsistent in format, often incomplete and rapidly evolving, the overall quality of data collected or accessed in the healthcare industry is often subject to challenge, the degree or amount of data which is knowingly or unknowingly absent or omitted can be material, and we often discover data issues and errors when monitoring and auditing the quality of our data. If we make mistakes in the capture, input, or analysis of these data, our ability to advance the development of our product candidates may be materially harmed and our business, prospects and reputation may suffer.

We also engage in the procurement of regulatory approvals necessary for the development and commercialization of our product candidates, for which we manage and submit data to governmental entities. These processes and submissions are governed by complex data processing and validation policies and regulations. Notwithstanding such policies and regulations, interim, top-line or preliminary data from our clinical trials that we announce or publish from time to time may change as more patient data become available and are subject to audit and verification procedures that could result in material changes in the final data, in which case we may be exposed to liability to a customer, court or government agency that concludes that our storage, handling, submission, delivery or display of health information or other data was wrongful or erroneous. Although we maintain insurance coverage for clinical trials this coverage may prove to be inadequate or could cease to be available to us on acceptable terms, if at all. Even unsuccessful claims could result in substantial costs and diversion of management time, attention, and resources. A claim brought against us that is uninsured or under-insured could harm our business, financial condition and results of operations.

In addition, we rely on CROs and other third parties to monitor and manage data for some of our ongoing preclinical studies and clinical trials and control only certain aspects of their activities. If any of our CROs or other third parties do not perform to our standards in terms of data accuracy or completeness, data from those preclinical studies and clinical trials may be compromised as a result, and our reliance on these parties does not relieve us of our regulatory responsibilities. For a detailed discussion, see “— Risks Related to Our Reliance on Third Parties — As we rely on third parties to conduct our preclinical studies, clinical trials, contract manufacture drug substances and drug products, and provide other important services related to product development, regulatory submissions, and commercialization, if we lose our relationships with these third parties or if they do not successfully carry out their contractual duties, comply with applicable laws, or meet expected deadlines, we may not be able to obtain regulatory approval for or commercialize our product candidates and our business could be substantially harmed” below.

***The incidence and prevalence for target patient populations of our product candidates are based on estimates and third-party sources. The market opportunities for our product candidates, if approved, may be smaller than we anticipate.***

We expect to initially seek approval of LBS-008 for the treatment of STGD1. Our projections of the number of patients with STGD1 and the portion of those patients that would benefit from treatment with LBS-008 are based on our beliefs and estimates, including data published by third parties, including scientific literature, patient foundations and publicly available databases, and on internally generated data and assumptions. While we believe our market size information is generally reliable, such information is inherently imprecise, and relies on our and third parties’ projections, assumptions and estimates within our target market, which are necessarily subject to a high degree of uncertainty and risk due to a variety of factors,

including those described in this prospectus. If such third-party or internally generated data prove to be inaccurate or we make errors in our projections, assumptions or estimates based on that data, our addressable target market opportunity and/or our future growth rate may be less than we currently estimate. Further, new sources may reveal a change in the estimated number of patients, and the number of patients may turn out to be lower than expected. Additionally, the potential addressable patient population for our current programs or future product candidates may be limited. Accordingly, the information regarding the size of our addressable market opportunity included in this prospectus should not be taken as indicative of our future growth.

The ultimate market opportunity for our product candidates will depend on, among other things, the final labeling for such product candidates as agreed with the FDA, the TGA, the NMPA, the EMA and any other applicable comparable foreign regulatory authorities, acceptance by the medical community and patient access, potential competition and drug pricing and reimbursement. Even if we obtain significant market share for any product candidate, if approved, if the potential target populations are small, we may never achieve profitability without obtaining marketing approval for additional indications, which may significantly harm our business, financial condition, results of operations and prospects.

***Product liability lawsuits against us could divert our resources, cause us to incur substantial liabilities and limit commercialization of any products that we may develop.***

We face an inherent risk of product liability claims as a result of the clinical testing of our product candidates despite obtaining appropriate informed consents from our clinical trial participants. We will face an even greater risk if we or any future collaborators commercially sell any product that we or they may develop. For example, we may be sued if any product we develop allegedly causes injury or is found to be otherwise unsuitable during clinical testing, manufacturing, marketing or sale. Any such product liability claims may include allegations of defects in manufacturing, defects in design, a failure to warn of dangers inherent in the product, negligence, strict liability or a breach of warranties. Claims could also be asserted under state consumer protection acts. If we cannot successfully defend ourselves against product liability claims, we may incur substantial liabilities or be required to limit commercialization of our product candidates.

Regardless of the merits or eventual outcome, liability claims may result in significant negative consequences to our business and prospects, including, but not limited to:

- decreased demand for our product candidates or any resulting products;
- injury to our reputation;
- withdrawal of other clinical trial participants;
- costs to defend the related litigation;
- a diversion of our management's time and resources;
- substantial monetary awards to study participants or patients; and
- a decline in the market price of our ADSs.

We currently carry liability insurance covering our clinical trials. Although we maintain such insurance, any claim that may be brought against us could result in a court judgment or settlement in an amount that is not covered, in whole or in part, by our insurance or which is in excess of the limits of our insurance coverage. Our insurance policies also contain various exclusions, and we may be subject to particular liability claims for which we have no coverage. We will have to pay any amount awarded by a court or negotiated in a settlement that exceed our coverage limitations or that are not covered by our insurance, and we may not have, or be able to obtain, sufficient capital to pay such amounts. In addition, if we cannot successfully defend ourselves against such claims, we may incur substantial liabilities and be required to suspend or delay our ongoing clinical trials. Even a successful defense would require significant financial and management resources.

***Illegal and/or parallel imports and counterfeit pharmaceutical products may reduce demand for our future approved product candidates and could have a negative impact on our reputation and business.***

The illegal importation of competing products from countries where government price controls or other market dynamics result in lower prices may adversely affect the demand for our future approved

product candidates and, in turn, may adversely affect our sales and profitability in the United States, China and other countries where we plan to commercialize our products. Unapproved foreign imports of prescription drugs are illegal under the current laws of the United States, Australia and China. However, illegal imports may continue to occur or even increase as the ability of patients and other customers to obtain these lower priced imports continues to grow. Furthermore, cross-border imports from lower-priced markets (which are known as parallel imports) into higher-priced markets could harm sales of our future drug products and exert commercial pressure on pricing within one or more markets. In addition, government authorities may expand consumers' ability to import lower priced versions of our future approved products or competing products from outside the United States, Australia, China or other countries where we operate or expect to operate. Any future legislation or regulations that increase consumer access to lower priced medicines from outside the United States, China or other countries where we operate could have a material adverse effect on our business.

Certain products distributed or sold in the pharmaceutical market may be manufactured without proper licenses or approvals, or be fraudulently mislabeled with respect to their content or manufacturers. These products are generally referred to as counterfeit pharmaceutical products. The counterfeit pharmaceutical product control and enforcement system, particularly in developing markets may be inadequate to discourage or eliminate the manufacturing and sale of counterfeit pharmaceutical products imitating our products. Since counterfeit pharmaceutical products in many cases have very similar appearances compared with the authentic pharmaceutical products but are generally sold at lower prices, counterfeits of our products could quickly erode the demand for our future approved product candidates.

In addition, counterfeit pharmaceutical products are not expected to meet our rigorous manufacturing and testing standards. A patient who receives a counterfeit pharmaceutical product may be at risk for a number of dangerous health consequences. Our reputation and business could suffer harm as a result of counterfeit pharmaceutical products sold under our brand name(s). In addition, thefts of inventory at warehouses, plants or while in-transit, which are not properly stored and which are sold through unauthorized channels, could adversely impact patient safety, our reputation and our business.

#### **Risks Related to Our Financial Position and Need for Additional Capital**

***We have recorded net cash outflow from operating activities since our inception. Even if we consummate this offering, we will need to obtain additional financing to fund our operations. If we are unable to obtain such financing, we may be unable to complete the development and commercialization of our product candidates.***

Since our inception, our operations have consumed substantial amounts of cash. We raised a total of approximately \$40.6 million in pre-IPO financing in the past three fiscal years and the net cash used in our operating activities was approximately \$4.4 million for the year ended December 31, 2020 and approximately \$7.5 million for the year ended December 31, 2021.

We expect our expenses to increase in connection with our ongoing activities, particularly as we initiate new clinical trials of, initiate new research and preclinical development efforts for and seek marketing approval for, our product candidates. In addition, if we obtain marketing approval for any of our product candidates, we may incur significant commercialization expenses related to product sales, marketing, manufacturing and distribution to the extent that such sales, marketing, manufacturing and distribution are not the responsibility of a future collaborator. Furthermore, following the completion of this offering, we expect to incur significant additional costs associated with operating as a public company. Accordingly, we will need to obtain substantial additional funding in connection with our continuing operations. Our financing to fund our operations may be adversely affected, delayed or fail to raise because of capital market environment, valuation of our company or the progress of our competitors. If we are unable to raise capital when needed or on attractive terms, we may be forced to delay, reduce or eliminate our research and development programs or any future commercialization efforts.

The net proceeds of this offering and our existing cash on hand will not be sufficient to fund all of the efforts that we plan to undertake or to fund the completion of development of any of our product candidates. Accordingly, we will be required to obtain further funding through public or private equity offerings, debt financings, collaborations and licensing arrangements or other sources. We do not have any committed external source of funds. Adequate additional financing may not be available to us on acceptable terms, or at all.

Our failure to raise capital as and when needed would have a negative impact on our financial condition and our ability to pursue our business strategy.

Our existing cash on hand will not be sufficient to enable us to meet our short-term obligations or long-term plans, including commercialization of clinical pipeline products, if approved, or initiation or completion of future clinical trials. Our future funding requirements, both short-term and long-term, will depend on many factors, including:

- the number of future product candidates that we pursue and their development requirements;
- the scope, progress, timing, results and costs of discovering, researching and developing product candidates, and conducting preclinical studies and clinical trials;
- the scope, prioritization and number of our research and development programs;
- the costs, timing and outcome of regulatory review of our product candidates;
- the cost of manufacturing our product candidates and any products we commercialize, including costs associated with expanding our supply chain;
- the cost and timing of future commercialization activities, including product manufacturing, marketing, sales and distribution, for any of our product candidates for which we receive regulatory approval;
- the cash received, if any, from commercial sales of any product candidates for which we receive regulatory approval;
- our ability to establish and maintain strategic collaborations, licensing or other arrangements and the financial terms of such collaborations and arrangements;
- the extent to which we acquire or in-license other product candidates and technologies;
- our headcount growth and associated costs;
- the costs, timing and outcome of preparing, filing and prosecuting patent applications, maintaining and enforcing our intellectual property rights and defending any intellectual property-related claims;
- resources required to develop and implement policies and processes to promote ongoing compliance with applicable healthcare laws and regulations;
- the impact of COVID-19 on the initiation or completion of preclinical studies or clinical trials and the supply of our product candidates;
- costs required to ensure that our and any of our partners' business arrangements with third parties comply with applicable healthcare laws and regulations; and
- the costs of operating as a public company in the United States.

***We have a limited operating history and no history of commercializing pharmaceutical products, which may make it difficult to evaluate the prospects for our future viability.***

We are a global clinical-stage biopharmaceutical company with a limited operating history and no history of commercializing pharmaceutical products. Our operations to date have been limited to financing and staffing our company, developing our technology and conducting preclinical research and clinical trials for our product candidates. We have not yet demonstrated an ability to successfully obtain marketing approvals for or commercialize our product candidates or manufacture our product candidates on a scale sufficient to supply the commercial markets. We have no products approved for commercial sale and have not generated any revenue from product sales. Consequently, any predictions about our future success or viability may not be as accurate as they could be if we had a longer operating history and/or approved products on the market.

Our limited operating history and the fact that we have yet to commercialize a pharmaceutical product, particularly in light of the rapidly evolving drug research and development industry in which we operate and the changing regulatory and market environments we encounter, may make it difficult to evaluate our



prospects for future performance. As a result, any assessment of our future performance or viability is subject to significant uncertainty. We will encounter risks and difficulties frequently experienced by early-stage companies in rapidly evolving fields as we seek to transition to a company capable of supporting commercial activities.

As we continue to build our business, we expect our financial condition and operating results may fluctuate significantly from quarter to quarter and year to year due to a variety of factors, many of which are beyond our control. Accordingly, you should not rely upon the results of any particular quarterly or annual period as indications of future operating performance.

***We have incurred net losses since our inception and anticipate that we will continue to incur net losses for the foreseeable future and may never achieve or maintain profitability. If we are unable to achieve or sustain profitability, the market value of our ADSs will likely decline.***

We have incurred significant annual net operating losses in every year since our inception. We expect to continue to incur significant and increasing net operating losses for at least the next several years. Our net losses were approximately \$5.8 million and \$9.7 million for the years ended December 31, 2020 and 2021, respectively. As of December 31, 2021, we had an accumulated deficit of approximately \$27.2 million. We have not generated any revenues from product sales, have not completed the development of any product candidate and may never have a product candidate approved for commercialization. We have financed our operations to date primarily through private placements of our preferred stock. We have devoted substantially all of our financial resources and efforts to research and development, including preclinical studies and our clinical trials. Our net losses may fluctuate significantly from quarter to quarter and year to year. Net losses and negative cash flows have had, and will continue to have, an adverse effect on our stockholders' equity and working capital.

We anticipate that our expenses will increase substantially if and as we:

- continue to develop and conduct clinical trials with respect to our lead product candidate, LBS-008;
- initiate and continue research, preclinical and clinical development efforts for any future product candidates;
- seek regulatory approvals for our product candidates;
- commercialize our product candidates once we have obtained marketing approval;
- establish sales, marketing, distribution and other commercial infrastructure in the future to commercialize various products for which we may obtain marketing approval, if any;
- hire additional clinical, operational, financial and administrative, quality control and scientific personnel;
- add operational, financial and management information systems and personnel, including personnel to support our product development and help us comply with our obligations as a public company;
- require the manufacture of larger quantities of product candidates for clinical development and, potentially, commercialization;
- seek to identify additional product candidates and technologies;
- obtain, maintain, expand and protect our intellectual property portfolio;
- enforce and defend any intellectual property-related claims;
- acquire or in-license other product candidates, intellectual property and technologies;
- enter into out-licensing and co-development collaborations consistent with our global strategy;
- add equipment and physical infrastructure to support our research and development
- incur setbacks or delays to the initiation or completion of preclinical studies, drug development and/or clinical trials due to COVID-19; and
- incur any disruption or delays to the supply of our product candidates due to COVID-19.

To become and remain profitable, we must develop and eventually commercialize product candidates with significant market potential. This will require us to be successful in a range of challenging activities, including completing preclinical testing and clinical trials of, and obtaining marketing approval for, our product candidates, manufacturing, marketing and selling, either directly or through collaborations, those product candidates for which we may obtain marketing approval and satisfying any post-marketing requirements. We may not succeed in any or all of these activities and, even if we do, we may never generate revenues that are significant or large enough to achieve profitability. In the process of attempting to become and remain profitable, we may encounter unforeseen expenses, difficulties, complications, delays and other unknown factors that may adversely affect our business. The size of our future net losses will depend partially on the rate of the future growth of our expenses, our ability to generate revenues and the timing and amount of payments that we receive from or pay to third parties. If any of our product candidates fails during preclinical studies or clinical trials or does not gain regulatory approval, or, even if approved, fails to achieve market acceptance, our business may not become profitable. Even if we achieve profitability in the future, we may not be able to sustain profitability in subsequent periods thereafter. Our prior losses and expected future losses have had, and will continue to have, an adverse effect on our working capital and the value of our Company. This could impair our ability to raise future capital, maintain our research and development efforts, proceed with commercialization efforts, expand our business or otherwise continue our operations, and could harm our competitive position in the marketplace. A decline in the value of our Company also could cause you to lose all or part of your investment.

***Our recurring losses from operations could continue to raise substantial doubt regarding our ability to continue as a going concern. Our ability to continue as a going concern requires that we obtain sufficient funding to finance our operations.***

We have incurred significant operating losses since our inception and have never generated product revenue, and it is possible we will never generate product revenue or profit. Accordingly, we have concluded that substantial doubt exists regarding our ability to continue as a going concern. Meaningful revenues will likely not be available until and unless any current or future product candidate is approved by the FDA, the NMPA, the EMA or comparable regulatory agencies in other countries and successfully marketed, either by us or a partner, an outcome which may not occur. Our financial statements appearing at the end of this prospectus have been prepared on a going concern basis, which contemplates the realization of assets and satisfaction of liabilities in the ordinary course of business. These financial statements do not include any adjustments relating to the recoverability and classification of recorded asset amounts or the amounts and classification of liabilities that might result from the outcome of these uncertainties related to our ability to operate on a going concern basis. The perception that we may not be able to continue as a going concern may cause others to choose not to deal with us due to concerns about our ability to meet our contractual obligations.

Our independent registered public accounting firm included an explanatory paragraph in its audit report on our financial statements as of and for the year ended December 31, 2021, stating that we have an accumulated deficit, incurred recurring losses from operations, have an expectation of continuing operating losses for the foreseeable future, and need to raise capital to finance our future operations, which raise substantial doubt about our ability to continue as a going concern. Our ability to continue as a going concern depends on our ability to raise additional capital. If we seek additional financing to fund our business activities in the future and there remains substantial doubt about our ability to continue as a going concern, investors or other financing sources may be unwilling to provide additional funding to us on commercially reasonable terms or at all. Further, if we cannot continue as a going concern, we may be forced to discontinue operations and liquidate our assets and may receive less than the value at which those assets are carried on our audited financial statements, which would cause holders of our ADSs and our shareholders to lose all or a part of their investment.

***Our ability to use our net operating loss carry forwards may be subject to limitation.***

As of December 31, 2020 and 2021, our subsidiaries had U.S. net operating loss carryforwards for federal and state tax purposes of approximately \$3.7 million and \$4.0 million, respectively. If not utilized, the federal and state net operating loss carryforwards incurred before January 1, 2018 will begin to expire in 2036, and the remaining can be carried forward indefinitely but utilization is limited to 80% of our taxable

income in any given tax year based on current federal tax laws. The timing and manner in which we may utilize net operating losses may be limited by tax rules regarding changes in ownership and a lack of future taxable income could adversely affect our ability to utilize our net operating losses before they expire. In general, net operating losses in one country cannot be used to offset income in any other country and net operating losses in one state cannot be used to offset income in any other state. Accordingly, we may be subject to tax in certain jurisdictions even if we have unused net operating losses in other jurisdictions. Furthermore, each jurisdiction in which we operate may have its own limitations on our ability to utilize net operating losses or tax credit carryovers generated in that jurisdiction. These limitations may increase our U.S. federal, state or foreign income tax liability.

***Raising additional capital may cause dilution to holders of our ADSs and our shareholders, restrict our operations or require us to relinquish rights to our technologies or product candidates.***

We may seek additional funding through a combination of equity offerings, debt financings, collaborations, licensing arrangements, strategic alliances, government grants or subsidies. To the extent that we raise additional capital through the sale of equity or convertible debt securities, your ownership interest will be diluted, and the terms may include liquidation or other preferences that adversely affect your rights as a holder of our ADSs. The incurrence of additional indebtedness or the issuance of certain equity securities could give rise to increased fixed payment obligations and also result in certain restrictive covenants, such as limitations on our ability to incur additional debt or issue additional equity, limitations on our ability to acquire or license intellectual property rights and other operating restrictions that could adversely impact our ability to conduct our business. In addition, the issuance of additional equity securities, or the possibility of such issuance, may cause the market price of our ADSs to decline.

If we were to enter into collaborations or licensing arrangements in order to raise capital, we may be required to accept unfavorable terms, including relinquishing or licensing to a third party certain of our rights to technologies, future revenue streams, research programs or product candidates on unfavorable terms, which we would have otherwise sought to develop or commercialize on our own or reserve for future potential arrangements when we might be more likely to achieve more favorable terms.

**Risks Related to Regulatory Approval and Marketing of Our Product Candidates and Other Legal Compliance Matters**

***The regulatory approval processes of the FDA, the TGA, the NMPA, the EMA and other comparable regulatory authorities are time-consuming and may evolve over time, and if we are ultimately unable to obtain regulatory approval for our product candidates, our business will be substantially harmed.***

The time required to obtain the approval of the FDA, the TGA, the NMPA, the EMA and other comparable regulatory authorities is inherently uncertain and depends on numerous factors, including the substantial discretion of the regulatory authorities. Generally, such approvals take many years to obtain following the commencement of preclinical studies and clinical trials and timing can vary substantially based upon a variety of factors, including the type, complexity and novelty of the product candidate involved. In addition, approval policies, regulations or the type and amount of clinical data necessary to gain approval may change during the course of a product candidate's clinical development and may vary among jurisdictions, each of which may cause delays in regulatory review. However, we cannot guarantee that we will be able to obtain regulatory approvals in a timely manner, or at all, for our existing product candidates or any product candidates that we may discover, in-license or acquire and seek to develop in the future. Our product candidates may not be effective, may be only moderately effective or may prove to have serious adverse, undesirable or unacceptable side effects, toxicities or other characteristics that may preclude regulatory approval or prevent or limit commercial use.

Our product candidates could be delayed in receiving or fail to receive regulatory approval of the FDA, the TGA, the NMPA, the EMA or a comparable regulatory authority for many reasons, including, but not limited to, the following:

- disagreement with the number, design, size, conduct or implementation of our clinical trials; For example, the regulatory authorities may disagree with our clinical trial endpoints, the subjects of our clinical trials, the number of patients enrolled, or the disease we choose to treat with our product candidates;

- delays in obtaining regulatory approval or ethics committee approval to commence a clinical trial;
- failure to demonstrate that a product candidate is safe and effective and potent for its proposed indication;
- failure of our clinical trial results to meet the level of statistical significance required for approval;
- failure of our CROs, clinical trial sites or investigators to comply with relevant current good clinical practice, or cGCP, requirements or failure of our clinical trial process to pass GCP inspections;
- failure to demonstrate that a product candidate's clinical and other benefits outweigh its safety risks;
- disagreement with our interpretation of data from animal testing or preclinical studies or clinical trials;
- insufficient data collected from the clinical trials of our product candidates to support the submission and filing of an NDA, or other submissions or to obtain regulatory approval;
- failure of our product candidates to pass current good manufacturing practice, or cGMP, inspections during the regulatory review process or across the production cycle of our drug;
- failure of our clinical sites to pass audits carried out by the FDA, the TGA, the NMPA, the EMA or comparable regulatory authorities, resulting in a potential invalidation of our research data;
- findings by the FDA, the TGA, the NMPA, the EMA or comparable regulatory authorities of deficiencies related to our manufacturing processes or the facilities of third-party CMOs with whom we contract for preclinical, clinical and commercial supplies;
- changes in approval policies or regulations that render our preclinical and clinical data insufficient for approval;
- our CROs taking actions that materially and adversely impact our clinical trials; and
- failure of our clinical trial process to keep up with any scientific or technological advancements required by approval policies or regulations.

The FDA, the TGA, the NMPA, the EMA or a comparable regulatory authority may require more information, including additional preclinical or clinical data, to support approval, which may delay or prevent approval and our commercialization plans. Even if we were to obtain approval, regulatory authorities may approve any of our product candidates for fewer or more limited indications than we request, grant approval contingent on the performance of costly post-marketing clinical trials or approve a product candidate with an indication that is not desirable for the successful commercialization of that product candidate. Any of the foregoing scenarios could materially harm the commercial prospects of our product candidates.

***All material aspects of the research, development, manufacturing and commercialization of pharmaceutical products are heavily regulated.***

All jurisdictions in which we intend to conduct our pharmaceutical-industry activities regulate these activities in great depth and detail. We initially intend to focus our activities on our primary markets of the United States, Australia, Taiwan, Europe and China. These jurisdictions strictly regulate the pharmaceutical industry, and in doing so they employ broadly similar regulatory strategies, including regulation of product development and approval, manufacturing, and marketing, sales and distribution of products. However, there are differences in the regulatory regimes that make for a more complex and costly regulatory compliance burden for a company like us that plans to operate in these regions.

The process of obtaining regulatory approvals and compliance with appropriate laws and regulations requires the expenditure of substantial time and financial resources. Failure to comply with the applicable requirements at any time during the product development process and approval process, or after approval, may subject an applicant to administrative or judicial sanctions. These sanctions could include: refusal to approve pending applications; withdrawal of an approval; license revocation; clinical hold; voluntary or mandatory product recalls; product seizures; total or partial suspension of production or distribution; injunctions; fines; refusals of government contracts; providing restitution; undergoing disgorgement; or other civil or criminal penalties. Failure to comply with these regulations could have a material adverse effect on our business.

***The FDA, the TGA, the NMPA, the EMA and any other regulatory agencies may actively enforce the laws and regulations prohibiting the promotion of drugs for off-label uses.***

If any of our product candidates is approved and we are found to have improperly promoted off-label uses of those products, we may become subject to significant liability. The FDA, the TGA, the NMPA, the EMA and other regulatory agencies strictly regulate the promotional claims that may be made about prescription products, such as our product candidates, if approved. In particular, a product may not be promoted for uses that are not approved by the FDA, the TGA, the NMPA, the EMA or such other regulatory agencies as reflected in the product's approved labeling in applicable jurisdiction(s). If we receive marketing approval for a product candidate, physicians may nevertheless prescribe it to their patients in a manner that is inconsistent with the approved label. If we are found to have promoted such off-label uses, we may become subject to significant liability. For example, the U.S. federal government has successfully pursued judgments for large civil and criminal fines and penalties against companies for alleged improper promotion of off-label use and has enjoined several companies from engaging in off-label promotion. The U.S. federal government has also successfully pursued consent decrees, deferred prosecution agreements, and injunctions under which specified promotional conduct is changed or curtailed, and compliance is closely monitored. If we cannot successfully manage the promotion of our product candidates, if approved, we could become subject to significant liability, which would materially adversely affect our business and financial condition.

***Even if we obtain approval of our product candidates in one jurisdiction, we may never obtain approval for or commercialize them in any other jurisdiction, which would limit our ability to realize the maximum market potential of our product candidates.***

We cannot commercialize product candidates in the United States, Australia, China, Europe or another jurisdiction outside of the United States without first obtaining regulatory approval from the FDA, the TGA, the NMPA, the EMA or comparable foreign regulatory authorities. The process to develop, obtain regulatory approval for and commercialize product candidates is long, complex and costly both inside and outside of the United States and approval may not be granted. Clinical trials conducted in one country may not be accepted by regulatory authorities in other countries and obtaining regulatory approval in one country does not mean that regulatory approval will be obtained in any other country. Approval processes vary among countries and can involve additional product testing and validation and additional administrative review periods. Even if our product candidates were to successfully obtain regulatory approval in one jurisdiction, we would still need to seek approval in any other jurisdictions where we plan to market the product. Any safety issues, product recalls or other incidents related to products approved and marketed in one jurisdiction may impact approval of those products in other jurisdictions. Further, the failure to obtain approval in one jurisdiction may negatively impact our ability to obtain approval elsewhere.

Seeking foreign regulatory approval could result in difficulties and increased costs for us and require additional preclinical studies or clinical trials which could be costly and time consuming. Regulatory requirements can vary widely from country to country and could delay or prevent the introduction of our products in those countries. We do not have any product candidates approved for sale in any jurisdiction, including in international markets, and the majority of our employees have limited experience in obtaining regulatory approval in international markets. If we fail to comply with regulatory requirements in international markets or to obtain and maintain required approvals, or if regulatory approvals in international markets are delayed, the target market for our product candidates will be reduced and our ability to realize the maximum market potential of any product candidate that we develop will be adversely affected.

***The applicability of clinical data generated outside the United States is subject to FDA concurrence for its suitability in supporting approval in the United States. If the FDA or comparable regulatory agencies do not accept data from such trials, our development plans may be delayed, which could materially harm our business.***

Certain of our clinical trials supporting our lead product candidate were, and continue to be, conducted outside the United States in foreign countries such as Australia and Taiwan, and we, or any future collaborators, may choose to conduct one or more clinical trials or a portion of such clinical trials for our product candidates outside the United States. The acceptance of study data from clinical trials conducted outside the United States or another jurisdiction by the FDA or comparable foreign regulatory authority may

be subject to certain conditions or may not be accepted at all. In cases where data from foreign clinical trials are intended to serve as the sole basis for marketing approval in the United States, the FDA will generally not approve the application on the basis of foreign data alone unless (i) the data are applicable to the United States population and United States medical practice; (ii) the trials were performed by clinical investigators of recognized competence and pursuant to cGCP regulations; and (iii) the data may be considered valid without the need for an on-site inspection by the FDA, or if the FDA considers such inspection to be necessary, the FDA is able to validate the data through an on-site inspection or other appropriate means. In addition, even where the foreign study data are not intended to serve as the sole basis for approval, the FDA will not accept the data as support for an application for marketing approval unless the study is well-designed and well-conducted in accordance with cGCP requirements and the FDA is able to validate the data from the study through an onsite inspection if deemed necessary. Many foreign regulatory authorities have similar approval requirements. In addition, such foreign trials would be subject to the applicable local laws of the foreign jurisdictions where the trials are conducted. There can be no assurance that the FDA or any comparable foreign regulatory authority will accept data from trials conducted outside of the United States or the applicable jurisdiction. If the FDA or any comparable foreign regulatory authority does not accept such data, it would result in the need for additional trials, which could be costly and time-consuming, and which may result in current or future product candidates that we may develop not receiving approval for commercialization in the applicable jurisdiction.

***We, or any future collaborators, may not be able to obtain orphan drug designation or orphan drug exclusivity for our product candidates and, even if we do, that exclusivity may not prevent the FDA or the EMA from approving other competing products.***

Regulatory authorities in some jurisdictions, including the United States and Europe, may designate drugs for relatively small patient populations as orphan drugs. LBS-008 has received Orphan Drug Designation in the United States and Europe, which provides for 7 years and 10 years, respectively, of market exclusivity from approval for STGD1. LBS-008 has also received Rare Pediatric Disease Designation in the United States. We, or any future collaborators, may seek orphan drug designations for other product candidates and may be unable to obtain such designations.

Even if we, or any future collaborators, obtain orphan drug designation for a product candidate, we, or they, may not be able to obtain orphan drug exclusivity for that product candidate. Generally, a product with orphan drug designation only becomes entitled to orphan drug exclusivity if it receives the first marketing approval for the indication for which it has such designation, in which case the FDA will be precluded from approving another marketing application for the same product for that indication and the EMA will be precluded from accepting an application for, or granting a marketing authorization for, a “similar medicinal product” for the applicable exclusivity period. The applicable exclusivity period is seven years in the United States and ten years in Europe. The European exclusivity period can be reduced to six years if a drug no longer meets the criteria for orphan drug designation or if the drug is sufficiently profitable so that market exclusivity is no longer justified. Orphan drug exclusivity may be lost if the FDA or the EMA determines that the request for designation was materially defective or if the manufacturer is unable to assure sufficient quantity of the drug to meet the needs of patients with the rare disease or condition.

Even if we, or any future collaborators, obtain orphan drug exclusivity for a product, that exclusivity may not effectively protect the product from competition because different drugs can be approved for the same condition, and only the first applicant to receive approval will receive the benefits of marketing exclusivity. In addition, if a competitor’s drug receives marketing approval earlier than us in Europe which is deemed by the EMA as a “similar medicinal product” of any of our product candidates, then we may not be able to obtain orphan drug exclusivity for that product candidate. Even after an orphan drug is approved, the FDA can subsequently approve the same drug for the same condition if the FDA concludes that the later drug is clinically superior in that it is shown to be safer, more effective or makes a major contribution to patient care. In addition, in both the U.S. and Europe, if a different drug is subsequently approved for marketing for the same or a similar indication as any of our product candidates that receive marketing approval, we may face increased competition and lose market share regardless of orphan drug exclusivity, which only protects against approval of the “same” drug for the same indication.

***Although we may pursue expedited regulatory approval pathways in the United States for certain of our product candidates, they may not qualify for expedited development or, if they do qualify for expedited development, it may not actually lead to a faster development or regulatory review or approval process.***

Although we believe there may be an opportunity to accelerate the development of certain of our product candidates through one or more of the FDA's expedited programs and we may pursue one or more of these expedited programs, we cannot be certain that any of such product candidates will qualify for such programs or that we will be able to maintain such qualifications.

If we apply for any expedited program for any of our product candidates, the FDA may determine such product candidate, its proposed indication or other aspects of our clinical development plans do not qualify for such an expedited program. Even if we are successful in obtaining a designation or access to any expedited program, we may not experience faster development timelines or achieve faster review or approval compared to conventional FDA procedures. Access to an expedited program may also be withdrawn by the FDA if the FDA believes that the designation is no longer supported by data from our clinical development programs or if the FDA otherwise finds that relevant criteria are no longer being met. Additionally, qualification for any expedited review procedure does not ensure that we will ultimately obtain regulatory approval for any of our product candidates.

***Even if we receive regulatory approval for our product candidates, we will be subject to ongoing regulatory obligations and continued regulatory review, which may result in significant additional expenses, and we may be subject to penalties if we fail to comply with regulatory requirements or experience unanticipated problems with our product candidates.***

Even after obtaining regulatory approval from the FDA, the TGA, the NMPA, the EMA or a comparable regulatory authority, our product candidates will be subject to, among other things, ongoing regulatory requirements governing the manufacturing processes, labeling, packaging, distribution, adverse event reporting, storage, advertising, promotion, recordkeeping data management and submission of safety, efficacy and other post-market information. These requirements include submissions of safety and other post-marketing information and reports, registration, random quality control testing, adherence to any CMC, variations, continued compliance with cGMPs, and cGCPs and potential post-approval studies for the purposes of license renewal. Violations of the Federal Food, Drug, and Cosmetic Act, or the FDCA, relating to the promotion of prescription drugs may lead to FDA enforcement actions and investigations alleging violations of federal and state healthcare fraud and abuse laws, as well as state consumer protection laws.

Any regulatory approvals that we receive for our product candidates may also be subject to limitations on the approved indicated uses for which the drug may be marketed or to the conditions of approval, or contain requirements for potentially costly post-marketing studies, including Phase 4 studies for the surveillance and monitoring of the safety and efficacy of the drug.

In addition, once a drug is approved by the FDA, the TGA, the NMPA, the EMA or a comparable regulatory authority for marketing, it is possible that there could be a subsequent discovery of previously unknown problems with the drug, including problems with third-party CMOs or manufacturing processes, or failure to comply with regulatory requirements. If any of the foregoing occurs with respect to our drug products, it may result in, among other things:

- restrictions on the marketing or manufacturing of the drug, withdrawal of the drug from the market, or voluntary or mandatory drug recalls;
- fines, warning letters or holds on our clinical trials;
- refusal by the FDA, the TGA, the NMPA, the EMA or comparable regulatory authorities to approve pending applications or supplements to approved applications filed by us, or suspension or revocation of drug license approvals;
- refusal by the FDA, the TGA, the NMPA, the EMA or comparable regulatory authorities to accept any of our IND approvals or NDAs;
- drug seizure or detention, or refusal to permit the import or export of drugs; and
- injunctions or the imposition of civil, administrative or criminal penalties.

Any government investigation of alleged violations of law could require us to expend significant time and resources and could generate negative publicity. Moreover, regulatory policies may change or additional government regulations may be enacted that could prevent, limit or delay regulatory approval of our product candidates. If we are slow or unable to adapt to changes in existing requirements or the adoption of new requirements or policies or we are not able to maintain regulatory compliance, we may lose the regulatory approvals that we have already obtained and may not achieve or sustain profitability, which in turn could significantly harm our business, financial condition and prospects.

***Inadequate funding for the FDA and other government agencies could hinder their ability to hire and retain key leadership and other personnel, prevent new products from being developed or commercialized in a timely manner or otherwise prevent those agencies from performing normal business functions on which the operation of our business may rely, which could negatively impact our business.***

The ability of the FDA and comparable regulatory authorities (in some jurisdictions, the hospitals) to accept application, review and approve new products can be affected by a variety of factors, including government budget and funding levels, ability to hire and retain key personnel and accept the payment of user fees, and statutory, regulatory, and policy changes. Average review times at the agency have fluctuated in recent years as a result. In addition, government funding of other government agencies on which our operations may rely, including those that fund research and development activities is subject to the political process, which is inherently fluid and unpredictable.

Disruptions at the FDA and comparable regulatory authorities may also slow the time necessary for new drugs to be reviewed and/or approved by necessary government agencies, which would adversely affect our business. For example, in recent years, including in 2018 and 2019, the U.S. government shut down several times and certain regulatory agencies, such as the FDA, had to furlough critical employees and stop critical activities. Separately, in response to the COVID-19 pandemic, the FDA postponed most inspections of foreign manufacturing facilities and products, postponed routine surveillance inspections of domestic manufacturing facilities and is conducting only teleconference meetings. Regulatory authorities outside the United States may adopt similar restrictions or other policy measures in response to the COVID-19 pandemic. If a prolonged government shutdown occurs, it could significantly impact the ability of the FDA to timely review and process our regulatory submissions, which could have a material adverse effect on our business. Further, upon completion of this offering and in our operations as a public company, future government shutdowns could impact our ability to access the public markets and obtain necessary capital in order to properly capitalize and continue our operations.

***Current and future legislation may increase the difficulty and cost for us and any future collaborators to obtain marketing approval of and commercialize our product candidates and affect the prices we, or they, may obtain.***

In the United States and certain other jurisdictions, there have been a number of legislative and regulatory changes and proposed changes regarding the healthcare system that could prevent or delay marketing approval of our product candidates, restrict post-approval activities and affect our ability to sell profitably any product candidates for which we obtain marketing approval.

For example, the Patient Protection and Affordable Care Act, as amended by the Health Care and Education Reconciliation Act of 2010, collectively, the ACA, is a sweeping law intended to broaden access to health insurance, reduce or constrain the growth of healthcare spending, enhance remedies against fraud and abuse, add new transparency requirements for the healthcare and health insurance industries, impose new taxes and fees on the health industry and impose additional health policy reforms. Among the provisions of the ACA of importance to our product candidates are the following:

- an annual, nondeductible fee on any entity that manufactures or imports specified branded prescription drugs;
- an increase in the statutory minimum rebates a manufacturer must pay under the Medicaid Drug Rebate Program;
- expansion of healthcare fraud and abuse laws, including the False Claims Act and the Anti-Kickback Statute, new government investigative powers, and enhanced penalties for non-compliance;



- a new Medicare Part D coverage gap discount program, in which manufacturers must agree to offer 50% point-of-sale discounts off negotiated prices;
- extension of manufacturers' Medicaid rebate liability to utilization covered by Medicaid managed care plans;
- expansion of eligibility criteria for Medicaid programs;
- expansion of the entities eligible for discounts under the Public Health Service Act's pharmaceutical pricing program;
- new requirements to report to the Centers for Medicare & Medicaid Services, or the CMS, financial arrangements with physicians and teaching hospitals;
- a new requirement to annually report to the FDA drug samples that manufacturers and distributors provide to physicians; and
- a new Patient-Centered Outcomes Research Institute to oversee, identify priorities in, and conduct comparative clinical effectiveness research, along with funding for such research.

Legislative and regulatory proposals have been made to expand post-approval requirements, to restrict sales and promotional activities for pharmaceutical products and to control rising market prices for pharmaceutical products. We cannot be sure whether additional legislative changes will be enacted, or whether the FDA regulations, guidance or interpretations will be changed, what the impact of such changes on the marketing approvals, if any, of our product candidates may be, or whether pricing strategies may be constrained. In addition, increased scrutiny by the U.S. Congress of the FDA's approval process may significantly delay or prevent marketing approval, as well as subject us to more stringent product labeling and post-marketing conditions and other requirements.

#### **Risks Related to Our Intellectual Property**

*If we are unable to obtain and maintain patent and other intellectual property protection for our product candidates, or if the scope of such intellectual property rights obtained is not sufficiently broad, third parties could develop and commercialize products and technologies similar or identical to ours and compete directly against us, and our ability to successfully commercialize any product or technology may be adversely affected.*

Our success depends in large part on our ability to protect our proprietary technology and product candidates from competition by obtaining, maintaining, defending and enforcing our intellectual property rights, including patent rights. As of December 31, 2021, our portfolio of owned, co-owned, and in-licensed patents consisted of 18 issued U.S. patents, 8 pending U.S. patent applications, 14 issued foreign patents (inclusive of allowed applications) and 28 pending foreign patent applications, providing protection in the United States and China, among other regions. We seek to protect and intend to seek to protect the product candidates and technology that we consider commercially important by filing patent applications and requiring our licensor to file licensed patent applications in the United States, European Union, China, Japan, South Korea, Taiwan, Canada, Australia, India and other countries or regions, relying on trade secrets or pharmaceutical regulatory protection or employing a combination of these methods. This process is expensive and time-consuming, and we may not be able to file and prosecute all necessary or desirable patent applications in all jurisdictions at a reasonable cost or in a timely manner. It is also possible that we will fail to identify patentable aspects of our research and development output before it is too late to obtain patent protection.

The patent position of biotechnology and pharmaceutical companies generally is highly uncertain, involves complex legal and factual questions and has in recent years been the subject of much litigation. As a result, the issuance, scope, validity, enforceability and commercial value of our patent rights are highly uncertain. Our owned, co-owned, and in-licensed pending and future patent applications may not result in patents being issued which protect our technology or product candidates or which effectively prevent others from commercializing competitive technologies and product candidates. The patent examination process may require us to narrow the scope of the claims of our owned, co-owned, and in-licensed pending and future patent applications, which may limit the scope of patent protection that may be obtained. We cannot assure that all of the potentially relevant prior art relating to our owned, co-owned, and in-licensed patents

and patent applications has been found. If such prior art exists, it can invalidate a patent or prevent a patent application from being issued as a patent.

Even if patents do issue on any of these applications, there can be no assurance that a third party will not challenge their validity, enforceability, or scope, which may result in the patent claims being narrowed or invalidated, or that we will obtain sufficient claim scope in those patents to prevent a third party from competing successfully with our product candidates. We may become involved in interference, *inter partes* review, post grant review, ex parte reexamination, derivation, opposition or similar other proceedings challenging our patent rights or the patent rights of others. An adverse determination in any such proceeding could reduce the scope of, or invalidate, our patent rights, allow third parties to commercialize our technology or product candidates and compete directly with us, or result in our inability to manufacture or commercialize product candidates without infringing third-party patent rights. Thus, even if our owned, co-owned, and in-licensed patent applications issue as patents, they may not issue in a form that will provide us with any meaningful protection, prevent competitors from competing with us or otherwise provide us with any competitive advantage.

Our competitors may be able to circumvent our owned, co-owned, and in-licensed patents by developing similar or alternative technologies or product candidates in a non-infringing manner. The issuance of a patent is not conclusive as to its scope, validity or enforceability, and our owned, co-owned, and in-licensed patents may be challenged in the courts or patent offices in the United States and other countries. Such challenges may result in patent claims being narrowed, invalidated or held unenforceable, which could limit our ability to stop or prevent us from stopping others from using or commercializing similar or identical technology and product candidates, or limit the duration of the patent protection of our technology and product candidates. Given the amount of time required for the development, testing and regulatory review of new product candidates, patents protecting such assets might expire before or shortly after such assets are commercialized. As a result, our patent portfolio may not provide us with sufficient rights to exclude others from commercializing product candidates similar or identical to ours.

Changes in either the patent laws or interpretation of the patent laws in the United States and other countries may diminish the value of our owned, co-owned, and in-licensed patents or narrow the scope of our patent protection. Under the America Invents Act enacted in 2011, the United States moved to this first-to-file system in early 2013 from the previous system under which the first to make the claimed invention was entitled to the patent. Assuming the other requirements for patentability are met, the first to file a patent application is entitled to the patent. Publications of discoveries in the scientific literature often lag behind the actual discoveries, and patent applications in the United States and other jurisdictions are typically not published until 18 months after filing, or in some cases not at all. Therefore, we cannot be certain that we or our licensors were the first to make the inventions claimed in our owned, co-owned, and in-licensed patents or pending patent applications, or that we or our licensors were the first to file for patent protection of such inventions.

***We depend on intellectual property licensed from third parties, and our current and future licensors may not always act in our best interest. If we fail to comply with our obligations under our intellectual property licenses, if the licenses are terminated or if disputes regarding these licenses arise, we could lose significant rights that are important to our business.***

We are dependent on patents, know-how and proprietary technology licensed from others. We are party to an exclusive license agreement with Columbia University under which we are granted rights to intellectual property that are necessary to our business and we may enter into additional license agreements in the future. Our existing license agreement with Columbia University imposes on us, and we expect that any future license agreements where we in-license intellectual property will impose on us, various development, regulatory and/or commercial diligence obligations, requiring timely achievement of development milestones for which we are obligated to report periodically on our progress and timely payment of milestone payments and/or royalties and other obligations. If we fail to comply with our obligations under these agreements, and our licensor does not agree to adjust the deadlines by which milestones must be achieved or we are subject to bankruptcy-related proceedings, the licensor may have the right to convert our exclusive license to a nonexclusive license with no right to sublicense or terminate the license, in which event we would not be able to develop or market products covered by the license.

If we or our licensors fail to adequately protect our licensed intellectual property, our ability to commercialize product candidates could suffer. We do not have complete control over the maintenance, prosecution and litigation of our in-licensed patents and patent applications and may have limited control over future intellectual property that may be in-licensed. For example, we cannot be certain that activities such as the maintenance and prosecution by our licensors have been or will be conducted in accordance with our views or in compliance with applicable laws and regulations or will result in valid and enforceable patents and other intellectual property rights. Our licensor is required to consult with us and keep us informed on the status of all licensed patents and applications, so long as we do not challenge the validity, scope, or enforceability of any licensed patent or application. It is also possible that our licensors' infringement proceedings or defense activities may be less vigorous than had we conducted them ourselves, or may not be conducted in accordance with our best interests.

In addition, the agreements under which we license intellectual property or technology from third parties are complex, and certain provisions in such agreements may be susceptible to multiple interpretations. The resolution of any contract interpretation disagreement that may arise could narrow what we believe to be the scope of our rights to the relevant patents, know-how and proprietary technology, or increase what we believe to be our financial or other obligations under the relevant agreement. Disputes that may arise between us and our licensors regarding intellectual property subject to a license agreement could include disputes regarding:

- the scope of rights granted under the license agreement and other interpretation-related issues;
- whether and the extent to which our technology and processes infringe on intellectual property of the licensor that is not subject to the licensing agreement;
- our right to sublicense patent and other rights to third parties under collaborative development relationships;
- our diligence obligations with respect to the use of the licensed technology in relation to our development and commercialization of our product candidates and what activities satisfy those diligence obligations; and
- the inventorship and ownership of inventions and know-how resulting from the joint creation or use of intellectual property by our licensors and us and our partners.

If disputes over intellectual property that we have licensed prevent or impair our ability to maintain our current licensing arrangements on reasonable terms, we may be unable to successfully develop and commercialize the affected technology or product candidates. As a result, any termination of or disputes over our intellectual property licenses could result in the loss of our ability to develop and commercialize our product candidates, or we could lose other significant rights, any of which could have a material adverse effect on our business, financial condition, results of operations and prospects.

***If we fail to comply with our obligations under our patent license with a third party, we could lose license rights that are important to our business.***

We are party to an exclusive license agreement with Columbia University pursuant to which we license key patent and patent applications necessary to pursue marketing and selling of our product candidates. Our existing license agreement with Columbia University imposes various diligence, milestone payment, royalty, insurance and other obligations on us. If we fail to comply with these obligations, our licensor may elect to convert the license from an exclusive license to a nonexclusive license without the right to sublicense or initiate legal proceedings against third party patent infringers or terminate the license, in which event we would not be able to develop or market the products covered by such licensed intellectual property. Termination of these agreements or reduction or elimination of our rights under these agreements, or restrictions on our ability to freely assign or sublicense our rights under such agreements when it is in the interest of our business to do so, may impede, delay or prohibit the further development or commercialization of one or more product candidates that rely on such agreements.

We may have limited control over the maintenance and prosecution of these in-licensed patents and patent applications, activities or any other intellectual property that may be related to our in-licensed intellectual property. For example, we cannot be certain that such activities by our licensor have been or will

be conducted in compliance with applicable laws and regulations or will result in valid and enforceable patents and other intellectual property rights.

***Intellectual property discovered through U.S. government funded programs may be subject to federal regulations such as “march-in” rights, certain reporting requirements and a preference for U.S.-based companies. Compliance with such regulations may limit our exclusive rights and limit our ability to contract with non-U.S. manufacturers.***

Our licensed and co-owned patents and pending patent applications have been generated through the use of U.S. government funding, and we may acquire or license in the future intellectual property rights that have been generated through the use of U.S. government funding or grants. Pursuant to the Bayh-Dole Act of 1980, the U.S. government has certain rights in inventions developed with government funding. These U.S. government rights include a non-exclusive, non-transferable, irrevocable worldwide license to use inventions for any governmental purpose. In addition, the U.S. government has the right, under certain limited circumstances, to require us to grant exclusive, partially exclusive, or non-exclusive licenses to any of these inventions to a third party if it determines that: (1) adequate steps have not been taken to commercialize the invention; (2) government action is necessary to meet public health or safety needs; or (3) government action is necessary to meet requirements for public use under federal regulations (also referred to as “march-in rights”). If the U.S. government exercised its march-in rights in our future intellectual property rights that are generated through the use of U.S. government funding or grants, we could be forced to license or sublicense intellectual property developed by us or that we license on terms unfavorable to us, and there can be no assurance that we would receive compensation from the U.S. government for the exercise of such rights. The U.S. government also has the right to take title to these inventions if the grant recipient fails to disclose the invention to the government or fails to file an application to register the intellectual property within specified time limits. Intellectual property generated under a government funded program is also subject to certain reporting requirements, compliance with which may require us to expend substantial resources. In addition, the U.S. government requires that any products embodying any of these inventions or produced through the use of any of these inventions be manufactured substantially in the United States. This preference for U.S. industry may be waived by the federal agency that provided the funding if the owner or assignee of the intellectual property can show that reasonable but unsuccessful efforts have been made to grant licenses on similar terms to potential licensees that would be likely to manufacture substantially in the United States or that under the circumstances domestic manufacture is not commercially feasible. This preference for U.S. industry may limit our ability to contract with non-U.S. product manufacturers for products covered by such intellectual property.

***We enjoy only limited geographical protection with respect to certain patents and may not be able to protect our intellectual property rights throughout the world.***

Filing and prosecuting patent applications and defending patents covering our product candidates in all countries throughout the world could be prohibitively expensive. Competitors may use our technologies in jurisdictions where we have not obtained patent protection to develop their own product candidates and, further, may export otherwise infringing product candidates to territories, where we have patent protection, but enforcement rights are not as strong as those in the United States. These product candidates may compete with our product candidates, and our owned, co-owned, and in-licensed patents or other intellectual property rights may not be effective or sufficient to prevent them from competing.

The laws of some jurisdictions do not protect intellectual property rights to the same extent as the laws or rules and regulations in the United States, and many companies have encountered significant difficulties in protecting and defending such rights in such jurisdictions. The legal systems of certain countries, particularly certain developing countries, are not as favorable as other jurisdictions with regard to the enforcement of patents, trade secrets and other intellectual property protection, which could make it difficult for us to stop the infringement of our owned, co-owned, and in-licensed patents or marketing of competing product candidates in violation of our proprietary rights generally and specifically in certain jurisdictions. Proceedings to enforce our patent rights in other jurisdictions, whether or not successful, could result in substantial costs and divert our efforts and attention from other aspects of our business, could put our patents at risk of being invalidated or interpreted narrowly and our owned, co-owned, and in-licensed patent applications at risk of not issuing as patents, and could provoke third parties to assert claims against us. We may not

prevail in any lawsuits that we initiate and the damages or other remedies awarded, if any, may not be commercially meaningful. Accordingly, our efforts to enforce our intellectual property rights around the world may be inadequate to obtain a significant commercial advantage from the intellectual property that we develop. Furthermore, while we intend to protect our intellectual property rights in our expected significant markets, we cannot ensure that we will be able to initiate or maintain similar efforts in all jurisdictions in which we may wish to market our product candidates. Accordingly, our efforts to protect our intellectual property rights in such countries may be inadequate, which may have an adverse effect on our ability to successfully commercialize our product candidates in all of our expected significant foreign markets. If we encounter difficulties in protecting, or are otherwise precluded from effectively protecting, the intellectual property rights important for our business in such jurisdictions, the value of these rights may be diminished, and we may face additional competition from others in those jurisdictions.

Some countries also have compulsory licensing laws under which a patent owner may be compelled to grant licenses to third parties. In addition, some countries limit the enforceability of patents against government agencies or government contractors. In those countries, the patent owner may have limited remedies, which could materially diminish the value of such patents. If we are forced to grant a license to third parties with respect to any patents relevant to our business, our competitive position may be impaired.

Enforcing our intellectual property rights against third parties may also cause such third parties to file other counterclaims against us, which could be costly to defend and could require us to pay substantial damages, cease the sale of certain drugs or enter into a license agreement and pay royalties (which may not be possible on commercially reasonable terms or at all).

***Obtaining and maintaining our patent protection depends on compliance with various procedural, document submission, fee payment, and other requirements imposed by governmental patent agencies, and our patent protection could be reduced or eliminated for non-compliance with these requirements.***

Periodic maintenance and annuity fees on any issued patent are due to be paid to the USPTO and foreign patent agencies over the lifetime of a patent. In addition, the USPTO and other foreign patent agencies require compliance with a number of procedural, documentary, fee payment, and other similar provisions during the patent application process. In some circumstances, we are dependent on our licensors to take the necessary action to comply with these requirements with respect to our licensed intellectual property. While an inadvertent failure to make payment of such fees or to comply with such provisions can in many cases be cured by payment of a late fee or by other means in accordance with the applicable rules, there are situations in which such non-compliance will result in the abandonment or lapse of the patent or patent application, and the partial or complete loss of patent rights in the relevant jurisdiction. Non-compliance events that could result in abandonment or lapse of a patent or patent application include failure to respond to official actions within prescribed time limits, and non-payment of fees and failure to properly legalize and submit formal documents within prescribed time limits. If we or our licensors fail to maintain the patents and patent applications covering our product candidates or if we or our licensors otherwise allow our owned, co-owned, or in-licensed patents or patent applications to be abandoned or lapse, our competitors might be able to enter the market, which would hurt our competitive position and could impair our ability to successfully commercialize our product candidates in any indication for which they are approved.

The COVID-19 pandemic may impair our and our licensors' ability to comply with these procedural, document submission, fee payment, and other requirements imposed by government patent agencies, which may materially and adversely affect our ability to obtain or maintain patent protection for our products and product candidates.

***Terms of our future owned, co-owned, or in-licensed patents may not be sufficient to effectively protect our product candidates and business in certain jurisdictions.***

In many countries where we file applications for patents, the term of an issued patent is generally 20 years from the earliest claimed filing date of a non-provisional patent application in the applicable country. Although various extensions may be available, the life of a patent and the protection it affords are limited. Even if we obtain patents covering our product candidates, we may still be open to competition from other companies, as well as generic medications once the patent life has expired for a drug. For example,

while there are patent regulations in the PRC in respect of regulatory data protection of new drugs containing new chemical components, there are currently no other clear mechanisms providing patent term extension or patent linkages for other drugs in the PRC. Therefore, it is possible that a lower-cost generic drug can emerge onto the market much more quickly. For additional information regarding generic competition for our products in China, see “— Risks Related to Our Intellectual Property — The uncertainty of patent linkage, patent term extension and data and market exclusivity for NMPA-approved pharmaceutical products could increase the risk of early generic competition with our products in China” below. These factors may result in weaker protection for us against generic competition in jurisdictions similar to the PRC than could be available to us in other jurisdictions, such as the United States. In addition, patents which we expect to obtain in the PRC or similar jurisdictions may not be eligible to be extended for patent terms lost during clinical trials and the regulatory review process.

If we are unable to obtain patent term extensions or if such extensions are less than requested for, our competitors may obtain approval of competing products following our patent expirations and our business, financial condition, results of operations and prospects could be materially harmed as a result.

***If the FDA or comparable foreign regulatory authorities approve generic versions of any of our products that receive marketing approval, or such authorities do not grant our products appropriate periods of data exclusivity before approving generic versions of our products, the sales of our products could be adversely affected.***

Once an NDA is approved, the product covered thereby becomes a “reference-listed drug” in the FDA’s publication, “Approved Drug Products with Therapeutic Equivalence Evaluations,” or the Orange Book. Manufacturers may seek approval of generic versions of reference-listed drugs through submission of abbreviated new drug applications, or ANDAs, in the United States. In support of an ANDA, a generic manufacturer need not conduct clinical trials. Rather, the applicant generally must show that its product has the same active ingredient(s), dosage form, strength, route of administration and conditions of use or labeling as the reference-listed drug and that the generic version is bioequivalent to the reference-listed drug, meaning it is absorbed in the body at the same rate and to the same extent. Generic products may be significantly less costly to bring to market than the reference-listed drug and companies that produce generic products are generally able to offer them at lower prices. Thus, following the introduction of a generic drug, a significant percentage of the sales of any branded product or reference-listed drug may be typically lost to the generic product.

The FDA may not approve an ANDA for a generic product until any applicable period of non-patent exclusivity for the reference-listed drug has expired. The Federal Food, Drug, and Cosmetic Act, or FDCA, provides a period of five years of non-patent exclusivity for a new drug containing a new chemical entity, or NCE. Specifically, in cases where such exclusivity has been granted, an ANDA may not be filed with the FDA until the expiration of five years unless the submission is accompanied by a Paragraph IV certification that a patent covering the reference-listed drug is either invalid or will not be infringed by the generic product, in which case the applicant may submit its application four years following approval of the reference-listed drug. It is unclear whether the FDA will treat the active ingredients in our product candidates as NCEs and, therefore, afford them five years of NCE data exclusivity if they are approved. If any product we develop does not receive five years of NCE exclusivity, the FDA may approve generic versions of such product three years after its date of approval, subject to the requirement that the ANDA applicant certifies to any patents listed for our products in the Orange Book. Manufacturers may seek to launch these generic products following the expiration of the applicable marketing exclusivity period, even if we still have patent protection for our product.

Competition that our products may face from generic versions of our products could negatively impact our future revenue, profitability and cash flows and substantially limit our ability to obtain a return on our investments in those product candidates.

***The uncertainty of patent linkage, patent term extension and data and market exclusivity for NMPA-approved pharmaceutical products could increase the risk of early generic competition with our products in China.***

In the United States, the Federal Food, Drug and Cosmetic Act, as amended by the Drug Price Competition and Patent Term Restoration Act, or the Hatch-Waxman Act, provides the opportunity for patent-term restoration, meaning a patent term extension of up to five years to reflect patent term lost during

certain portions of product development and the FDA regulatory review process. The Hatch-Waxman Act also has a process for patent linkage, pursuant to which the FDA will stay approval of certain follow-on applications during the pendency of litigation between the follow-on applicant and the patent holder or licensee, generally for a period of 30 months. Finally, the Hatch-Waxman Act provides for statutory exclusivities that can prevent submission or approval of certain follow-on marketing applications. For example, federal law provides a five-year period of exclusivity within the United States to the first applicant to obtain approval of a new chemical entity and three years of exclusivity protecting certain innovations to previously approved active ingredients where the applicant was required to conduct new clinical investigations to obtain approval for the modification. Similarly, the U.S. Orphan Drug Act provides seven years of market exclusivity for certain drugs to treat rare diseases, where the FDA designates the product candidate as an orphan drug and the drug is approved for the designated orphan indication. These provisions, designed to promote innovation, can prevent competing products from entering the market for a certain period of time after the FDA grants marketing approval for the innovative product.

Depending upon the timing, duration and specifics of any FDA marketing approval process for any product candidates we may develop, one or more of our owned, co-owned, or in-licensed U.S. patents, if issued, may be eligible for limited patent term extension under the Hatch-Waxman Act. The Hatch-Waxman Act permits a patent extension term of up to five years as compensation for patent term lost during clinical trials and the FDA regulatory review process. A patent term extension cannot extend the remaining term of a patent beyond a total of 14 years from the date of drug approval, only one patent may be extended and only those claims covering the approved drug, a method for using it, or a method for manufacturing it may be extended. The application for patent term extension is subject to approval by the U.S. Patent and Trademark Office, or USPTO, in conjunction with the FDA. However, we may not be granted an extension because of, for example, failing to exercise due diligence during the testing phase or regulatory review process, failing to apply within applicable deadlines, failing to apply prior to expiration of relevant patents, or otherwise failing to satisfy applicable requirements. Furthermore, the applicable time period or the scope of patent protection afforded could be less than we request. If we are unable to obtain a patent term extension for a given patent or the term of any such extension is less than we request, the period during which we will have the right to exclusively market our drug will be shortened and our competitors may obtain earlier approval of competing drugs, and our ability to generate revenues could be materially adversely affected.

In China, however, laws on patent term extension, patent linkage, and data exclusivity (referred to as regulatory data protection) are still developing. Therefore, a lower-cost generic drug can emerge onto the market much more quickly. Chinese regulators have set forth a framework for integrating patent linkage and data exclusivity into the Chinese regulatory regime, as well as for establishing a pilot program for patent term extension. According to the Economic and Trade Agreement Between the Government of the United States of America and the Government of the People's Republic of China, dated January 15, 2020, the PRC government undertook to provide patent term extensions to compensate for unreasonable delays that occur in granting the patent or during pharmaceutical product marketing approvals. In October 2020, the Standing Committee of the National People's Congress, or the NPC, promulgated the newly amended PRC Patent Law, which became effective in June 2021. The newly amended PRC Patent Law includes provisions for patent linkage and patent term extension. However, considering that the newly amended PRC Patent Law is relatively new, it is unclear how it will be implemented, and there exist great uncertainties with respect to its interpretation and implementation by the authorities. These factors result in weaker protection for us against generic competition in China than could be available to us in the United States. If we are unable to obtain patent term extension or the term of any such extension is less than we request, our competitors may obtain approval of competing products following our patent expiration, and our business, financial condition, results of operations, and prospects could be materially harmed.

***Changes in patent law could diminish the value of patents in general, thereby impairing our ability to protect our product candidates.***

As is the case with other biopharmaceutical companies, our success is heavily dependent on intellectual property, particularly patent rights. Obtaining and enforcing patents in the biopharmaceutical industry involves both technological and legal complexity, and is therefore costly, time-consuming, and inherently uncertain. In addition, the United States has recently enacted and is currently implementing wide-ranging



patent reform legislation. Recent U.S. Supreme Court rulings have narrowed the scope of patent protection available in certain circumstances and weakened the rights of patent owners in certain situations. In addition to increasing uncertainty with regard to our ability to obtain patents in the future, this combination of events has created uncertainty with respect to the value of patents once obtained, if any. Depending on decisions by the U.S. Congress, the federal courts and the USPTO, the laws and regulations governing patents could change in unpredictable ways that would weaken our ability to obtain new patents or to enforce our existing patents and patents that we might obtain in the future.

For example, the America Invents Act includes a number of significant changes that affect the way patent applications will be prosecuted and also may affect patent litigation. These include allowing third party submission of prior art to the USPTO during patent prosecution and additional procedures to attack the validity of a patent by USPTO administered post-grant proceedings, including post-grant review, inter partes review and derivation proceedings. Because of a lower evidentiary standard in USPTO proceedings compared to the evidentiary standard in United States federal courts necessary to invalidate a patent claim, a third party could potentially provide evidence in a USPTO proceeding sufficient for the USPTO to hold a claim invalid even though the same evidence would be insufficient to invalidate the claim if first presented in a district court action. Accordingly, a third party may attempt to use the USPTO procedures to invalidate our owned, co-owned, and in-licensed patent claims that would not have been invalidated if first challenged by the third party as a defendant in a district court action. Therefore, the America Invents Act and its implementation could increase the uncertainties and costs surrounding the prosecution of our owned, co-owned and in-licensed patent applications and the enforcement or defense of patents issuing from those patent applications, all of which could have a material adverse effect on our business, financial condition, results of operations and prospects.

Although we do not believe that our currently owned, co-owned, and in-licensed issued patents and any patents that may issue from our owned, co-owned, and in-licensed pending patent applications directed to our product candidates, if issued in their currently pending forms, will be found invalid based on any recent decisions by the U.S. Congress, federal courts and the USPTO, we cannot predict how their future decisions may impact the value of our patent rights. There could be similar changes in the laws of foreign jurisdictions that may impact the value of our patent rights or our other intellectual property rights.

***If we are unable to protect the confidentiality of our trade secrets, our business and competitive position would be harmed.***

In addition to patents, we rely upon unpatented trade secrets, know-how and continuing technological innovation to develop and maintain our competitive position. We seek to protect this trade secret and confidential information, in part, by entering into non-disclosure and confidentiality agreements with parties that have access to them, such as our employees, corporate collaborators, outside scientific collaborators, sponsored researchers, CMOs, consultants, advisers and other third parties. We also enter into confidentiality and invention or patent assignment agreements with our employees and consultants. However, any of these parties may breach such agreements and disclose our proprietary information, and we may not be able to obtain adequate remedies for such breaches. Enforcing a claim that a party illegally disclosed or misappropriated a trade secret can be difficult, expensive and time-consuming, and the outcome is unpredictable. If any of our trade secrets were to be lawfully obtained or independently developed by a competitor or other third party, we would have no right to prevent them from using that technology or information to compete with us and our competitive position would be harmed. In addition, we face the risk of cybercrime. For instance, someone could hack our information networks and gain illicit access to our proprietary information, including our trade secrets. Even if we are successful in prosecuting such claims, any remedy awarded may be insufficient to fully compensate us for the improper disclosure or misappropriation. In addition, some courts inside and outside the United States are less willing or unwilling to protect trade secrets.

***We also may be subject to claims that our employees, consultants, or advisers have wrongfully used or disclosed alleged trade secrets of their former employers or claims asserting ownership of what we regard as our own intellectual property.***

Many of our employees, consultants, and advisers, including our senior management, were previously employed at or contracted by other biotechnology or pharmaceutical companies, including our competitors



or potential competitors. Some of these employees, consultants, and advisers, including members of our senior management, executed proprietary rights, non-disclosure and non-competition agreements in connection with such previous employment. Although we try to ensure that our employees do not use the proprietary information or know-how of others in their work for us, we may be subject to claims that we or these employees have used or disclosed intellectual property, including trade secrets or other proprietary information, of any such individual's former employer. We are not aware of any threatened or pending claims related to these matters or concerning the agreements with our senior management, but in the future litigation may be necessary to defend against such claims. If we fail in defending any such claims, in addition to paying monetary damages, we may lose valuable intellectual property rights or personnel. Even if we are successful in defending against such claims, litigation could result in substantial costs and be a distraction to management. In addition, while we typically require our employees, consultants and contractors who may be involved in the development of intellectual property to execute agreements assigning such intellectual property to us, we may be unsuccessful in executing such an agreement with each party who in fact develops intellectual property that we regard as our own, and furthermore, the assignment of intellectual property rights may not be self-executing, or the assignment agreements may be breached, each of which may result in claims by or against us related to the ownership of such intellectual property. If we fail in prosecuting or defending any such claims, in addition to paying monetary damages, we may lose valuable intellectual property rights. Even if we are successful in prosecuting or defending against such claims, litigation could result in substantial costs, be a distraction to our management and scientific personnel and have a material adverse effect on our business, financial condition, results of operations and prospects.

***We may be subject to claims challenging the inventorship of our patents and other intellectual property.***

We may be subject to claims that former employees, collaborators or other third parties have an interest in our patent rights, trade secrets, or other intellectual property as an inventor or co-inventor. For example, we may have inventorship disputes arise from conflicting obligations of consultants or others who are involved in developing our therapeutic programs and other proprietary technologies we may develop. Litigation may be necessary to defend against these and other claims challenging inventorship or our patent rights, trade secrets or other intellectual property. If we fail in defending any such claims, in addition to paying monetary damages, we may lose valuable intellectual property rights, such as exclusive ownership of, or right to use, intellectual property that is important to our therapeutic programs and other proprietary technologies we may develop. Even if we are successful in defending against such claims, litigation could result in substantial costs and be a distraction to our management and other employees. Any of the foregoing could have a material adverse effect on our business, financial condition, results of operations and prospects.

***Intellectual property litigation may lead to unfavorable publicity which may harm our reputation and cause the market price of our ADSs to decline, and any unfavorable outcome from such litigation could limit our research and development activities and/or our ability to commercialize our product candidates.***

During the course of any intellectual property litigation, there could be public announcements of the results of hearings, rulings on motions, and other interim proceedings in the litigation. If securities analysts or investors regard these announcements as negative, the perceived value of our product candidates, future drugs, programs or intellectual property could be diminished. Accordingly, the market price of our ADSs may decline. Such announcements could also harm our reputation or the market for our product candidates, which could have a material adverse effect on our business.

In the event of intellectual property litigation, there can be no assurance that we would prevail, even if the case against us is weak or flawed. If third parties successfully assert their intellectual property rights against us, prohibitions against using certain technologies, or prohibitions against commercializing our product candidates, could be imposed by a court or by a settlement agreement between us and a plaintiff. In addition, if we are unsuccessful in defending against allegations that we have infringed, misappropriated or otherwise violated the patent or other intellectual property rights of others, we may be forced to pay substantial damage awards to the plaintiff. Additionally, we may be required to obtain a license from the intellectual property owner in order to continue our research and development activities or to commercialize any resulting product. It is possible that the necessary license will not be available to us on commercially acceptable terms, or at all. This may not be technically or commercially feasible, may render our products less

competitive, or may delay or prevent the launch of our products to the market. Any of the foregoing could limit our research and development activities, our ability to commercialize one or more product candidates, or both.

Most of our competitors are larger than we are and have substantially greater resources. They are, therefore, likely to be able to sustain the costs of complex intellectual property litigation longer than we could. In addition, the uncertainties associated with litigation could have a material adverse effect on our ability to raise the funds necessary to conduct our clinical trials, continue our internal research activities, in-license needed technology in the future, or enter into strategic collaborations that would help us bring our product candidates to market.

In addition, any future intellectual property litigation, interference or other administrative proceedings will result in additional expense and distraction of our personnel. An adverse outcome in such litigation or proceedings may expose us or any future strategic partners to loss of our proprietary position, expose us to significant liabilities, or require us to seek licenses that may not be available on commercially acceptable terms, if at all, each of which could have a material adverse effect on our business.

***We may not identify relevant third-party patents or may incorrectly interpret the relevance, scope or expiration of a third-party patent, which might adversely affect our ability to develop and market our products and product candidates.***

We cannot guarantee that any of our patent searches or analyses, including the identification of relevant patents, the scope of patent claims or the expiration of relevant patents, are complete or thorough, nor can we be certain that we have identified each and every third-party patent and pending patent application in the United States and abroad that is relevant to or necessary for the commercialization of our current and future products and product candidates in any jurisdiction. The scope of a patent claim is determined by an interpretation of the law, the written disclosure in a patent and the patent's prosecution history. Our interpretation of the relevance or the scope of a patent or a pending patent application may be incorrect, which may negatively impact our ability to market our products. We may incorrectly determine that our products or product candidates are not covered by a third-party patent or may incorrectly predict whether a third party's pending patent application will issue with claims of relevant scope. Our determination of the expiration date of any patent in the United States or abroad that we consider relevant may be incorrect, and our failure to identify and correctly interpret relevant patents may negatively impact our ability to develop and market our products. Any of the foregoing could have a material adverse effect on our business, financial condition, results of operations and prospects.

***Claims that our product candidates or the sale or use of our future products infringe, misappropriate or otherwise violate the patents or other intellectual property rights of third parties could result in costly litigation or could require substantial time and money to resolve, even if litigation is avoided.***

We cannot guarantee that our product candidates or the sale or use of our future products do not and will not in the future infringe, misappropriate or otherwise violate third-party patents or other intellectual property rights. Third parties might allege that we are infringing their patent rights or that we have misappropriated their trade secrets, or that we are otherwise violating their intellectual property rights, whether with respect to the manner in which we have conducted our research, or with respect to the use or manufacture of the compounds we have developed or are developing. The various markets in which we plan to operate are subject to frequent and extensive litigation regarding patents and other intellectual property rights. Some claimants may have substantially greater resources than we have and may be able to sustain the costs of complex intellectual property litigation to a greater degree and for longer periods of time than we could. Third parties might resort to litigation against us or other parties we have agreed to indemnify, which litigation could be based on either existing intellectual property or intellectual property that arises in the future.

It is also possible that we failed to identify, or may in the future fail to identify, relevant patents or patent applications held by third parties that cover our product candidates. Publication of discoveries in the scientific or patent literature often lags behind actual discoveries. Therefore, we cannot be certain that we or our licensors were the first to invent, or the first to file patent applications on, our product candidates or for their uses, or that our product candidates will not infringe patents that are currently issued or that are

issued in the future. In the event that a third party has also filed a patent application covering one of our product candidates or a similar invention, our owned, co-owned, or in-licensed patent application may be regarded as a competing application and may not be issued in the end. Additionally, pending patent applications that have been published can, subject to certain limitations, be later amended in a manner that could cover our products or their use.

If a third party were to assert claims of patent infringement against us, even if we believe such third-party claims are without merit, a court of competent jurisdiction could hold that these third-party patents are valid, enforceable and infringed, and the holders of any such patents may be able to block our ability to commercialize the applicable product unless we obtained a license under the applicable patents, or until such patents expire or are finally determined to be invalid or unenforceable. Similarly, if any third-party patents were held by a court of competent jurisdiction to cover aspects of our compositions, formulations, or methods of treatment, prevention, or use, the holders of any such patents may be able to block our ability to develop and commercialize the applicable product unless we obtained a license or until such patent expires or is finally determined to be invalid or unenforceable. In addition, defending such claims would cause us to incur substantial expenses and could cause us to pay substantial damages, if we are found to be infringing a third party's patent rights. These damages potentially include increased damages and attorneys' fees if we are found to have infringed such rights willfully. In order to avoid or settle potential claims with respect to any patent or other intellectual property rights of third parties, we may choose or be required to seek a license from a third party and be required to pay license fees or royalties or both, which could be substantial. These licenses may not be available on acceptable terms, or at all. Even if we were able to obtain a license, the rights may be nonexclusive, which could result in our competitors gaining access to the same intellectual property. Ultimately, we could be prevented from commercializing a product candidate, or be forced, by court order or otherwise, to modify or cease some or all aspects of our business operations, if, as a result of actual or threatened patent or other intellectual property claims, we are unable to enter into licenses on acceptable terms. Further, we could be found liable for significant monetary damages as a result of claims of intellectual property infringement.

Defending against claims of patent infringement, misappropriation of trade secrets or other violations of intellectual property rights is likely to be costly and time-consuming, regardless of the outcome. Furthermore, because of the substantial amount of discovery required in connection with intellectual property litigation, there is a risk that some of our confidential information could be compromised by disclosure during this type of litigation. Thus, even if we were to ultimately prevail, or to settle at an early stage, such litigation could burden us with substantial unanticipated losses. Any claims of infringement, misappropriation or other violation of intellectual property made against us could have a material adverse effect on our business, financial condition, results of operations and prospects.

***Issued patents covering one or more of our product candidates could be found invalid or unenforceable if challenged in court.***

Despite measures we take to obtain and maintain patent and other intellectual property rights with respect to our product candidates, our intellectual property rights could be challenged or invalidated. For example, if we were to initiate legal proceedings against a third party to enforce a patent covering one of our product candidates, the defendant could counterclaim that our owned, co-owned, or in-licensed patent is invalid and/or unenforceable. Grounds for a validity challenge could be an alleged failure to meet any of several statutory requirements, for example, lack of novelty, obviousness, non-enablement, lack of sufficient written description or obviousness-type double patenting. Grounds for an unenforceability assertion could be an allegation that someone connected with prosecution of the patent withheld relevant information from the USPTO, the State Intellectual Property Office, or the SIPO, or the applicable foreign counterpart, or made a misleading statement, during prosecution. Although we believe that we and our licensor have conducted our patent prosecution in accordance with a duty of candor and in good faith, the outcome following legal assertions of invalidity and unenforceability during patent litigation is unpredictable. If a defendant were to prevail on a legal assertion of invalidity and/or unenforceability, we could lose at least part, and perhaps all, of the patent protection on a product candidate. Even if a defendant does not prevail on a legal assertion of invalidity and/or unenforceability, our owned, co-owned, or in-licensed patent claims may be construed in a manner that would limit our ability to enforce such claims against the defendant and others. Even if we establish infringement, the court may decide not to grant an injunction against further

infringing activity and instead award only monetary damages, which may not be an adequate remedy. In addition, if the breadth or strength of protection provided by our owned, co-owned, or in-licensed patents is threatened, it could dissuade companies from collaborating with us to license, develop, or commercialize our current or future product candidates. Any loss of patent protection could have a material adverse impact on one or more of our product candidates and our business.

Even if resolved in our favor, litigation or other legal proceedings relating to intellectual property claims may cause us to incur significant expenses and could distract our personnel from their normal responsibilities. In addition, there could be public announcements of the results of hearings, motions or other interim proceedings or developments, and if securities analysts or investors perceive these results to be negative, it could have a substantial adverse effect on the price of our common stock. Such litigation or proceedings could substantially increase our operating losses and reduce the resources available for development activities or any future sales, marketing or distribution activities. We may not have sufficient financial or other resources to conduct such litigation or proceedings adequately. Some of our competitors may be able to sustain the costs of such litigation or proceedings more effectively than we can because of their greater financial resources and more mature and developed intellectual property portfolios. Uncertainties resulting from the initiation and continuation of patent litigation or other proceedings could have a material adverse effect on our ability to compete in the marketplace. Furthermore, because of the substantial amount of discovery required in connection with intellectual property litigation, there is a risk that some of our confidential information could be compromised by disclosure during this type of litigation.

***We may not be successful in obtaining or maintaining necessary rights for our development pipeline through acquisitions and in-licenses.***

Because the development of certain of our product candidates may in the future involve the use of proprietary rights held by third parties, the growth of our business may depend in part on our ability to acquire and maintain licenses or other rights to use these proprietary rights.

We may be unable to acquire or in-license any compositions, methods of use, or other intellectual property rights from third parties that we identify. The licensing and acquisition of third-party intellectual property rights is a competitive area, and a number of more established companies are also pursuing strategies to license or acquire third-party intellectual property rights that we may consider attractive or necessary. These established companies may have a competitive advantage over us due to their size, cash resources and greater clinical development and commercialization capabilities. In addition, companies that perceive us to be a competitor may be unwilling to assign or license rights to us. We also may be unable to license or acquire third-party intellectual property rights on terms that would allow us to make an appropriate return on our investment or at all. If we are unable to successfully obtain rights to required third-party intellectual property rights or maintain the existing intellectual property rights we have, we may have to abandon development of the relevant product candidate, which could have a material adverse effect on our business, financial condition, results of operations and prospects for growth.

***If our trademarks and trade names are not adequately protected, we may not be able to build name recognition in our markets of interest and our competitive position may be adversely affected.***

As of December 31, 2021, we had one registered trademark in the United States, one registered trademark in EU, two registered trademarks in China, one registered trademark in Hong Kong, and one registered trademark in Japan, and one trademark application pending in Canada. We may not be able to obtain trademark protection in territories that we consider of significant importance to us. In addition, any of our trademarks or trade names, whether registered or unregistered, may be challenged, opposed, infringed, cancelled, circumvented or declared generic, or determined to be infringing on other marks, as applicable. We may not be able to protect our rights to these trademarks and trade names, which we will need to build name recognition by potential collaborators or customers in our markets of interest. Over the long term, if we are unable to establish name recognition based on our trademarks and trade names, we may not be able to compete effectively, and our business may be adversely affected.

***Intellectual property rights do not necessarily protect us from all potential threats to our competitive advantage.***

The degree of future protection afforded by our intellectual property rights is uncertain because intellectual property rights have limitations, and may not adequately protect our business, or permit us to maintain our competitive advantage. The following examples are illustrative:

- others may be able to make compounds that are similar to our product candidates but that are not covered by the claims of the patents that we own, co-own or exclusively license;
- we or our licensors or collaborators might not have been the first to make the inventions covered by the issued patents or pending patent applications that we own, co-own or exclusively license, which could result in the patents applied for not being issued or being invalidated after issuing;
- we or our licensors or collaborators might not have been the first to file patent applications covering certain of our inventions, which could result in the patents applied for not being issued or being invalidated after issuing;
- others may independently develop similar or alternative technologies or duplicate any of our technologies without infringing our intellectual property rights;
- it is possible that the pending and future patent applications that we own, co-own, or in-license will not lead to issued patents;
- issued patents that we own, co-own or in-license may not provide us with any competitive advantages, or may be held invalid or unenforceable, as a result of legal challenges by our competitors or other third parties;
- we or our licensors may obtain patents for certain compounds many years before we receive regulatory approval for drugs containing such compounds, and because patents have a limited life, which may begin to run out prior to the commercial sale of the related drugs, the commercial value of our patents may be limited;
- our competitors might conduct research and development activities in countries where we do not have patent rights and then use the information learned from such activities to develop competitive drugs for commercialization in our major markets;
- we may fail to develop additional proprietary technologies that are patentable;
- we may fail to apply for or obtain adequate intellectual property protection in all the jurisdictions in which we operate;
- third parties may gain unauthorized access to our intellectual property due to potential lapses in our information systems; and
- the patents of others may have an adverse effect on our business, for example by preventing us from commercializing one or more of our product candidates for one or more indications.

Any of the aforementioned threats to our competitive advantage could have a material adverse effect on our business and future prospects.

#### **Risks Related to Our Industry, Business and Operations**

*If we fail to implement and maintain an effective system of internal controls, we may be unable to accurately report our results of operations, meet our reporting obligations or prevent fraud, and investor confidence and the market price of our ADSs may be materially and adversely affected.*

Prior to this offering, we have been a private company with limited accounting and financial reporting personnel and other resources with which to address our internal controls and procedures. Our independent registered public accounting firm has not conducted an audit of our internal control over financial reporting. However, in connection with the audit of our consolidated financial statements for the year ended December 31, 2021, we and our independent registered public accounting firm identified one material weakness in our internal control over financial reporting as well as other control deficiencies.

As defined in the standards established by the United States Public Company Accounting Oversight Board of the United States (PCAOB), a “material weakness” is a deficiency, or a combination of deficiencies, in internal control over financial reporting, such that there is a reasonable possibility that a material misstatement of the company’s annual or interim financial statements will not be prevented or detected on a timely basis. The material weakness identified is related to our lack of formal policies and procedures to

establish risk assessment process and internal control framework. We are currently in the process of implementing a number of measures to address the material weakness and deficiency that has been identified. See “Management’s Discussion and Analysis of Financial Condition and Results of Operations — Internal Control Over Financial Reporting.” However, we cannot assure you that these measures may fully address the material weakness and deficiency in our internal control over financial reporting or that we may conclude that they have been fully remediated.

Furthermore, it is possible that, had our independent registered public accounting firm conducted an audit of our internal control over financial reporting, such accountant might have identified additional material weaknesses and deficiencies. Upon completion of this offering, we will become a public company in the United States subject to the Sarbanes-Oxley Act of 2002. Section 404 of the Sarbanes-Oxley Act requires that we include a report from management on the effectiveness of our internal control over financial reporting in our annual report on Form 20-F upon expiration of the statutory transition period. In addition, once we cease to be an “emerging growth company” as such term is defined in the JOBS Act, our independent registered public accounting firm must attest to and report on the effectiveness of our internal control over financial reporting. Our management may conclude that our internal control over financial reporting is not effective. Moreover, even if our management concludes that our internal control over financial reporting is effective, our independent registered public accounting firm, after conducting its own independent testing, may issue a report that is qualified if it is not satisfied with our internal controls or the level at which our controls are documented, designed, operated or reviewed, or if it interprets the relevant requirements differently from us. In addition, after we become a public company, our reporting obligations may place a significant strain on our management, operational and financial resources and systems for the foreseeable future. We may be unable to timely complete our evaluation testing and any required remediation.

During the course of documenting and testing our internal control procedures, in order to satisfy the requirements of Section 404 of the Sarbanes-Oxley Act of 2002, we may identify other weaknesses and deficiencies in our internal control over financial reporting. In addition, if we fail to maintain the adequacy of our internal control over financial reporting, as these standards are modified, supplemented or amended from time to time, we may not be able to conclude on an ongoing basis that we have effective internal control over financial reporting in accordance with Section 404 of the Sarbanes-Oxley Act of 2002. We may not be able to anticipate and identify accounting issues, or other risks critical to financial reporting that could materially impact the consolidated financial statements. Generally, if we fail to achieve and maintain an effective internal control environment, we could suffer material misstatements in our financial statements and fail to meet our reporting obligations, which would likely cause investors to lose confidence in our reported financial information. This could in turn limit our access to capital markets, harm our results of operations and lead to a decline in the trading price of our shares. Additionally, ineffective internal control over financial reporting could expose us to increased risk of fraud or misuse of corporate assets and subject us to potential delisting from the stock exchange on which we list, regulatory investigations and civil or criminal sanctions. We may also be required to restate our financial statements from prior periods.

***Our future success depends on our ability to attract, retain and motivate senior management and qualified scientific employees.***

We are highly dependent on the expertise of the members of our research and development team, as well as the principal members of our management. We have entered into employment agreements with our executive officers, but each of them may terminate their employment with us at any time with or without prior written notice. In addition, we currently do not have “key-man” insurance for any of our executive officers or other key personnel.

Recruiting, retaining and motivating qualified management, scientific, clinical, manufacturing and sales and marketing personnel will also be critical to our success. The loss of the services of our executive officers or other key employees could impede the achievement of our research, development and commercialization objectives and seriously harm our ability to successfully implement our business strategy. Further, replacing executive officers and key employees may be difficult and may take an extended period of time because of the limited number of individuals in our industry with the breadth of skills and experience required to successfully develop, gain regulatory approval of and commercialize drugs. Competition to hire

from this limited pool is intense, and we may be unable to hire, train, retain or motivate these key personnel on acceptable terms given the competition among numerous biopharmaceutical companies for similar personnel. We also experience competition for the hiring of scientific and clinical personnel from universities and research institutions. In addition, our management will be required to devote significant time to new compliance initiatives from our status as a public company, which may require us to recruit more management personnel.

Competition for skilled personnel is intense, particularly in the biotechnology industry. We face competition for personnel from other companies, universities, public and private research institutions and other organizations. This competition may limit our ability to hire and retain highly qualified personnel on acceptable terms, or at all. We may not be able to attract and retain these personnel on acceptable terms given the competition among numerous biotechnology companies for similar personnel. In addition, we rely on consultants and advisors, including scientific and clinical advisors, to assist us in formulating our research and development and commercialization strategy. Our consultants and advisors may be employed or may have commitments under consulting or advisory contracts with other entities that may limit their availability to us.

***If we do not achieve our projected development and commercialization goals in the timeframes we announce and expect, the commercialization of any of our product candidates may be delayed, and our business will be harmed.***

For planning purposes, we sometimes estimate the timing of the accomplishment of various scientific, clinical, regulatory and other product development objectives. These milestones may include our expectations regarding the commencement or completion of scientific studies and clinical trials, the regulatory submissions or commercialization objectives. From time to time, we may publicly announce the expected timing of some of these milestones, such as the completion of an ongoing clinical trial, the initiation of other clinical trials, receipt of regulatory approval or the commercial launch of a product. The achievement of many of these milestones may be outside of our control. All of these milestones are based on a variety of assumptions which may cause the timing of achievement of the milestones to vary considerably from our estimates, including:

- our available capital resources or capital constraints we experience;
- the rate of progress, costs and results of our clinical trials and research and development activities, including the extent of scheduling conflicts with participating clinicians and collaborators;
- our ability to identify and enroll patients who meet clinical trial eligibility criteria;
- our receipt of approvals by the FDA, the TGA, the NMPA, the EMA and comparable regulatory authorities in other jurisdictions, and the timing thereof;
- other actions, decisions or rules issued by regulators;
- our ability to access sufficient, reliable and affordable supplies of materials used in the manufacture of our product candidates;
- our ability to manufacture and supply clinical trial materials to our clinical sites on a timely basis;
- the efforts of our collaborators with respect to the commercialization of our products; and
- the securing of, costs related to, and timing issues associated with, commercial product manufacturing as well as sales and marketing activities.

If we fail to achieve announced milestones in the timeframes we expect, the commercialization of any of our product candidates may be delayed, and our business, results of operations, financial condition and prospects may be adversely affected.

***Our employees, independent contractors, consultants, collaborators and contract research organizations may engage in misconduct or other improper activities, including non-compliance with regulatory standards and requirements, which could cause significant liability for us and harm our reputation.***

We are exposed to the risk that our employees, independent contractors, consultants, collaborators and contract research organizations may engage in fraud or other misconduct, including intentional failures to

comply with FDA regulations or similar regulations of comparable non-U.S. regulatory authorities, to provide accurate information to the FDA or comparable non-U.S. regulatory authorities, to comply with manufacturing standards we have established, to comply with federal and state healthcare fraud and abuse laws and regulations and similar laws and regulations established and enforced by comparable non-U.S. regulatory authorities, to report financial information or data accurately or to disclose unauthorized activities to us. Such misconduct could also involve the improper use of information obtained in the course of clinical trials, which could result in regulatory sanctions and serious harm to our reputation. It is not always possible to identify and deter misconduct, and the precautions we take to detect and prevent this activity may not be effective in controlling unknown or unmanaged risks or losses or in protecting us from governmental investigations or other actions or lawsuits stemming from a failure to be in compliance with such laws, standards or regulations. If any such actions are instituted against us, and we are not successful in defending ourselves or asserting our rights, those actions could have a significant impact on our business and results of operations, including the imposition of significant fines or other sanctions.

***We will likely need to increase the size and capabilities of our organization, and we may experience difficulties in managing our growth.***

In order to execute our business plans, we expect that we will need to significantly increase the number of our employees and consultants and the scope of our operations, particularly in the areas of research and development, regulatory affairs and business development. We currently rely on some of the employees of our ultimate controlling shareholder to administer and supervise some of the clinical operations of our Company. See “Related Party Transactions — Other Transactions with Related Parties.” Our future financial performance and our ability to commercialize our product candidates and to compete effectively will depend, in part, on our ability to manage any future growth effectively. To manage our anticipated future growth, we will need to continue to implement and improve our managerial, operational and financial systems, expand our facilities and continue to recruit and train additional qualified personnel. Due to our limited financial resources, we may not be able to effectively manage the expansion of our operations or recruit and train additional qualified personnel. The expansion of our operations may lead to significant costs and may divert our management and business development resources. Any inability to manage growth could delay the execution of our business plans or disrupt our operations and have a material adverse effect on our business.

In addition, we currently rely, and for the foreseeable future will continue to rely, in substantial part on certain independent organizations, advisors and consultants to provide certain services. There can be no assurance that the services of these independent organizations, advisors and consultants will continue to be available to us on a timely basis when needed or that we can find qualified replacements. Furthermore, if we are unable to effectively manage our outsourced activities or if the quality or accuracy of the services provided by consultants is compromised for any reason, our clinical trials may be extended, delayed or terminated, and we may not be able to obtain regulatory approval of our product candidates or otherwise advance our business. There can be no assurance that we will be able to manage our existing consultants or find other competent outside contractors and consultants on economically reasonable terms, if at all.

If we are not able to effectively expand our organization by hiring new employees and expanding our groups of consultants and contractors, we may not be able to successfully implement the tasks necessary to further develop and commercialize our product candidates and, accordingly, may not achieve our research, development and commercialization goals.

***We have limited insurance coverage, and any claims beyond our insurance coverage may result in our incurring substantial costs and a diversion of resources.***

We maintain insurance policies that are required under applicable laws and regulations as well as insurance based on our assessment of our operational needs and industry practice. We also maintain liability insurance covering our clinical trials as well as certain other types of insurance. Our insurance coverage may be insufficient to cover any claim for product liability, damage to our fixed assets or employee injuries. Any liability or damage to, or caused by, our facilities or our personnel beyond our insurance coverage may result in our incurring substantial costs and a diversion of resources.



We also expect that operating as a public company will make it more difficult and more expensive for us to obtain director and officer liability insurance, and we may be required to accept reduced policy limits and coverage or incur substantially higher costs to obtain the same or similar coverage. As a result, it may be more difficult for us to attract and retain qualified people to serve on our board of directors, our board committees or as executive officers. We do not know, however, if we will be able to maintain existing insurance with adequate levels of coverage. Any significant uninsured liability may require us to pay substantial amounts, which would adversely affect our cash position and results of operations.

***Disruptions in the financial markets and economic conditions could affect our ability to raise capital.***

Global economies could suffer dramatic downturns as the result of a deterioration in the credit markets and related financial crisis as well as a variety of other factors including, extreme volatility in security prices, severely diminished liquidity and credit availability, ratings downgrades of certain investments and declining valuations of others. In the past, governments have taken unprecedented actions in an attempt to address and rectify these extreme market and economic conditions by providing liquidity and stability to the financial markets. If these actions are not successful, the return of adverse economic conditions may cause a significant impact on our ability to raise capital, if needed, on a timely basis and on acceptable terms or at all.

In addition, there is considerable uncertainty over the long-term effects of the expansionary monetary and fiscal policies adopted by the central banks and financial authorities of some of the world's leading economies, including the United States and China. There have been concerns over unrest and terrorist threats in the Middle East, Europe and Africa and over the conflicts involving Ukraine, Syria and North Korea. There have also been concerns relating to trade disputes between the United States and China and regarding the relationship among China and other Asian countries, which may result in or intensify potential conflicts in relation to territorial disputes among such countries. In addition, the United Kingdom held a referendum on June 23, 2016 on its membership in the European Union, in which a majority of voters in the United Kingdom voted to exit the European Union (commonly referred to as "Brexit"). Brexit could adversely affect European and worldwide economic and market conditions and could contribute to instability in global financial and foreign exchange markets. More recently, the occurrence of the COVID-19 pandemic has caused volatility in the global financial markets and threatened a slowdown in the global economy. For a detailed discussion regarding the potential impact of the COVID-19 pandemic, see "—Risks Related to Our Industry, Business and Operations — Business disruptions could seriously harm our future revenue and financial condition and increase our costs and expenses" below. It is unclear whether these challenges and uncertainties and the issues arising from the COVID-19 pandemic will be contained or resolved, and what effects they may ultimately have on the global political and economic conditions in the long term.

***Failure to renew our current leases or locate desirable alternatives for our leased properties could materially and adversely affect our business.***

We lease properties for our offices and laboratories. See "Business — Facilities" for more details of our leased properties. We may not be able to successfully extend or renew such leases upon expiration of the current term on commercially reasonable terms or at all, and may therefore be forced to relocate our affected operations. This could disrupt our operations and result in significant relocation expenses, which could adversely affect our business, financial condition and results of operations. In addition, we compete with other businesses for premises at certain locations or of desirable sizes. As a result, even though we could extend or renew our leases, rental payments may significantly increase as a result of the high demand for the leased properties. In addition, we may not be able to locate desirable alternative sites for our current leased properties as our business continues to grow and failure in relocating our affected operations could adversely affect our business and operations.

Although we have policies and procedures designed to ensure that we, our employees and our agents comply with the Trade Laws, there is no assurance that such policies or procedures will prevent our agents, employees and intermediaries from engaging in bribery activities. Failure to comply with the Trade Laws could disrupt our business and lead to severe criminal and civil penalties, including imprisonment, criminal and civil fines, loss of our export licenses, suspension of our ability to do business with the government, denial of government reimbursement for our products and/or exclusion from participation in government

healthcare programs, as well as reputational harm. Other remedial measures could include further changes or enhancements to our procedures, policies, and controls and potential personnel changes and/or disciplinary actions, any of which could have a material adverse effect on our business, financial condition, results of operations and liquidity. We could also be adversely affected by any allegation that we violated such laws.

***If we engage in future acquisitions or strategic collaborations, this may increase our capital requirements, dilute the value of your investment in our ADSs, cause us to incur debt or assume contingent liabilities, and subject us to other risks.***

We may evaluate various acquisitions and strategic collaborations, including licensing or acquiring complementary products, intellectual property rights, technologies or businesses. Any potential acquisition or strategic collaboration may entail numerous risks, including, but not limited to:

- increased operating expenses and working capital and cash requirements;
- the assumption of additional indebtedness or contingent liabilities;
- challenges with assimilation of operations, intellectual property and products of an acquired company, including difficulties associated with integrating new personnel;
- the diversion of our management's attention from our existing product candidates and initiatives in pursuing such a strategic merger or acquisition;
- the loss of key personnel, and uncertainties in our ability to maintain key business relationships;
- our inability to generate revenue from acquired technology and/or products sufficient to meet our objectives in undertaking the acquisition or even to offset the associated acquisition and maintenance costs;
- material weakness arising in our internal control over financial reporting because of a weaknesses in the acquired company's financial systems and controls; and
- changes in accounting principles relating to recognition and measurement of our investments that may have a significant impact on our financial results.

In addition, if we undertake acquisitions, we may issue dilutive securities, assume or incur debt obligations, incur large one-time expenses and acquire intangible assets that could result in significant future amortization expense. Moreover, we may not be able to locate suitable acquisition opportunities and this inability could impair our ability to grow or obtain access to technology or products that may be important to the development of our business.

***The tax laws of the jurisdictions in which we operate may adversely affect our business and our tax results.***

The tax laws applicable to our business activities are subject to change and uncertain interpretation. Our tax position could be adversely impacted by changes in tax rates, laws, practices, treaties or regulations or changes in the interpretation thereof by the authorities in jurisdictions in which we do business.

Moreover, we conduct operations through our subsidiaries in various tax jurisdictions pursuant to transfer pricing arrangements between us and our subsidiaries. While we believe that we operate in compliance with applicable transfer pricing laws and intend to continue to do so, our transfer pricing procedures are not binding on applicable tax authorities. If tax authorities in any jurisdiction in which we operate were to successfully challenge our transfer prices as not reflecting arms' length transactions, they could require us to adjust our transfer prices and thereby reallocate our income to reflect these revised transfer prices, which could result in a higher tax liability to us. Furthermore, a tax authority could assert that we are subject to tax in a jurisdiction where we believe we have not established a taxable connection, and such an assertion, if successful, could increase our expected tax liability in one or more jurisdictions. Such circumstances could adversely affect our financial condition, results of operations and cash flows.

***If we, our CROs or our other contractors or consultants fail to comply with environmental, health and safety laws and regulations, we could become subject to fines or penalties or incur costs that could have a material adverse effect on the success of our business.***

We and third parties, such as our CROs or other contractors or consultants, are subject to numerous environmental, health and safety laws and regulations, including those governing laboratory procedures and

the handling, use, storage, treatment and disposal of hazardous materials and wastes. Our operations may involve the use of hazardous and flammable materials, including chemicals and radioactive and biological materials. Our operations also produce hazardous waste products. We generally contract with third parties for the disposal of these materials and wastes. We cannot eliminate the risk of contamination or injury from these materials. In the event of contamination or injury resulting from our use of hazardous materials, we could be held liable for any resulting damages, and any liability could exceed our resources. We also could incur significant costs associated with civil or criminal fines and penalties.

In addition, we may be required to incur substantial costs to comply with current or future environmental, health and safety laws and regulations. These current or future laws and regulations may impair our research, development or production efforts. Failure to comply with these laws and regulations also may result in substantial fines, penalties or other sanctions.

***Our internal computer systems, or those used by our CROs or other contractors or consultants, may fail or suffer security breaches, which could result in a material disruption of our development of our product candidates.***

Despite the implementation of security measures, our internal information technology systems and those of our collaborators, contractors and consultants are vulnerable to damage from internal or external events, such as computer viruses, unauthorized access, natural disasters, terrorism, war, and telecommunication and electrical failures, which compromise the confidentiality, integrity and availability of the systems. Although to our knowledge we have not experienced any material system failure or security breach to date, if such an event were to occur and cause interruptions in our operations, it could result in a material disruption of our development programs and our business operations. For example, the loss of clinical trial data from completed or future clinical trials could result in delays in our regulatory approval efforts and significantly increase our costs to recover or reproduce the data. Likewise, we partially rely on our third-party research institution collaborators for research and development of our product candidates and other third parties for the manufacture of our product candidates and to conduct clinical trials, and similar events relating to their computer systems could also have a material adverse effect on our business.

In the ordinary course of our business, we collect and store sensitive data, including, among other things, personally identifiable information about our employees, intellectual property, and proprietary business information. Additionally, our CROs will collect and store sensitive data, such as legally protected patient health information, when conducting our clinical trials. We manage and maintain our applications and data utilizing on-site systems and outsourced vendors. These applications and data encompass a wide variety of business-critical information including research and development information, commercial information and business and financial information. Because information systems, networks and other technologies are critical to many of our operating activities, shutdowns or service disruptions at our Company or vendors that provide information systems, networks, or other services to us pose increasing risks. Such disruptions may be caused by events such as computer hacking, phishing attacks, ransomware, dissemination of computer viruses, worms and other destructive or disruptive software, denial of service attacks and other malicious activity, as well as power outages, natural disasters (including extreme weather), terrorist attacks or other similar events. Such events could cause loss of data, damage to system and data and leave us unable to utilize key business systems or access important data needed to operate our business, including conducting research and development, gaining regulatory approval for our product candidates or manufacturing and selling our products. Our collaborators, contractors or consultants may face similar risks, and service disruptions or security breaches of their systems could adversely affect our security, leave us without access to important systems, products, raw materials, components, services or information or expose our confidential data. In addition, system redundancy may be ineffective or inadequate, and our disaster recovery planning may not be sufficient to cover all eventualities. Significant events could result in a disruption of our operations, damage to our reputation or a loss of revenues. In addition, we may not have adequate insurance coverage to compensate for any losses associated with such events.

We could be subject to risks caused by misappropriation, misuse, leakage, falsification or intentional or accidental release or loss of information maintained in the information systems and networks of our Company and our vendors, including personal information of our employees and patients, and company and vendor confidential data. In addition, outside parties may attempt to penetrate our systems or those of our vendors or fraudulently induce our personnel or the personnel of our vendors to disclose sensitive

information in order to gain access to our data and/or systems. Like other companies, we may experience, threats to our data and systems, including malicious codes and viruses, phishing, business email compromise attacks, or other cyber-attacks. The number and complexity of these threats may increase over time. If a material breach of our information technology systems or those of our vendors occurs, the market perception of the effectiveness of our security measures could be harmed and our reputation and credibility could be damaged. We could be required to expend significant amounts of money and other resources to respond to these threats or breaches and to repair or replace information systems or networks and could suffer financial loss or the loss of valuable confidential information. In addition, we could be subject to regulatory actions and/or claims made by individuals and groups in private litigation involving privacy issues related to data collection and use practices and other data privacy laws and regulations, including claims for misuse or inappropriate disclosure of data, as well as unfair or deceptive practices. We are taking measures and plan to continue to take measures to develop and maintain systems and controls designed to prevent, identify and mitigate these events from occurring. The development and maintenance of these systems, controls and processes is costly and requires ongoing monitoring and updating as technologies change and efforts to overcome security measures become increasingly sophisticated. Moreover, despite our efforts, the possibility of these events occurring cannot be eliminated entirely. As we outsource more of our information systems to vendors, engage in more electronic transactions with payors and patients, and rely more on cloud-based information systems, the related security risks will increase and we will need to expend additional resources to protect our technology and information systems. In addition, there can be no assurance that our internal information technology systems or those of our collaborators, contractors, or our consultants' efforts to implement adequate security and control measures, will be sufficient to protect us against breakdowns, service disruption, data deterioration or loss in the event of a system malfunction, or prevent data from being stolen or corrupted in the event of a cyberattack, security breach, industrial espionage attacks or insider threat attacks that could adversely affect our business and operations and/or result in the loss or exposure of critical, proprietary, private, confidential or otherwise sensitive data, which could result in financial, legal, business or reputational harm to us.

***Failure to comply with existing or future laws and regulations related to privacy or data security could lead to government enforcement actions, which could include civil or criminal fines or penalties, private litigation, other liabilities, and/or adverse publicity. Compliance or the failure to comply with such laws could increase the costs of our products, could limit their use or adoption, and could otherwise negatively affect our operating results and business.***

The regulatory framework for the collection, use, safeguarding, sharing, transfer and other processing of personal information worldwide is rapidly evolving and is likely to remain uncertain for the foreseeable future. Regulatory authorities in virtually every jurisdiction in which we operate have implemented and are considering a number of legislative and regulatory proposals concerning personal data protection. Additionally, the interpretation and application of data protection laws in jurisdictions applicable to us are often uncertain and in flux. We therefore face uncertainty as to the exact interpretation of any such requirements, and we may be unsuccessful in implementing all measures required by data protection authorities or courts in interpretation of new laws.

In the United States, we are subject to laws and regulations that address privacy, personal information protection and data security at both the federal and state levels, including federal Health Insurance Portability and Accountability Act of 1996, or HIPAA, as amended by the Health Information Technology and Clinical Health Act, and its implementing regulations, which imposes certain requirements relating to the privacy, security and transmission of individually identifiable health information. Numerous laws and regulations, including security breach notification laws, health information privacy laws, and consumer protection laws, govern the collection, use, disclosure and protection of health-related and other personal information. Given the variability and evolving state of these laws, we face uncertainty as to the exact interpretation of the new requirements, and we may be unsuccessful in implementing all measures required by regulators or courts in their interpretation.

Regulatory authorities in Europe have implemented and are considering a number of legislative and regulatory proposals concerning data protection. For example, the General Data Protection Regulation (EU) 2016/ 679, or the GDPR, which became effective in May 2018, imposes a broad range of strict requirements on companies subject to the GDPR, such as us, including, but not limited to, requirements

relating to having legal bases for processing personal information relating to identifiable individuals and transferring such information outside the European Economic Area (including to the United States), providing details to those individuals regarding the processing of their personal information, keeping personal information secure, having data processing agreements with third parties who process personal information, responding to individuals' requests to exercise their rights in respect of their personal information, reporting security breaches involving personal data to the competent national data protection authority and affected individuals and recordkeeping. The GDPR substantially increases the penalties to which we could be subject in the event of any non-compliance, including fines of up to €10.0 million or up to 2% of our total worldwide annual turnover for certain comparatively minor offenses, or up to €20.0 million or up to 4% of our total worldwide annual turnover for more serious offenses. Given the new law, we face uncertainty as to the exact interpretation of the new requirements, and we may be unsuccessful in implementing all measures required by data protection authorities or courts in interpretation of the new law. National laws of member states of the European Union are in the process of being adapted to the requirements under the GDPR. Because the GDPR specifically gives member states flexibility with respect to certain matters, national laws may partially deviate from the GDPR and impose different obligations from country to country, leading to additional complexity and uncertainty.

We expect that we will continue to face uncertainty as to whether our efforts to comply with evolving obligations under global data protection, privacy and security laws will be sufficient. Any failure or perceived failure by us to comply with applicable laws and regulations could result in reputational damage or proceedings or actions against us by governmental entities, individuals or others. These proceedings or actions could subject us to significant civil or criminal penalties, damages, injunctive relief and negative publicity, result in the delayed or halted transfer or confiscation of certain personal information, require us to change our business practices, increase our costs and otherwise materially harm our business, prospects, financial condition and results of operations. In addition, our current and future relationships with customers, vendors, pharmaceutical collaborators and other third parties could be negatively affected by any proceedings or actions against us or current or future data protection obligations imposed on them under applicable law. In addition, to the extent that any disruption or security breach were to result in a loss of, or damage to, our data or applications, or inappropriate disclosure of confidential or proprietary information, we could incur significant legal and financial exposure and reputational damage that could potentially have an adverse effect on the development of our product candidates and our business.

***Business disruptions could seriously harm our future revenue and financial condition and increase our costs and expenses.***

Natural disasters, acts of war or terrorism or other factors beyond our control may adversely affect the economy, infrastructure and livelihood of the people in the regions where we conduct our business or whether our studies are conducted. Our operations may be under the threat of floods, earthquakes, sandstorms, snowstorms, fire or drought, power, water or fuel shortages, failures, malfunction and breakdown of information management systems, unexpected maintenance or technical problems, or may be susceptible to potential wars or terrorist attacks, or public health threats and epidemics, including the global health concerns relating to the COVID-19 pandemic. Serious natural disasters may result in loss of lives, injury, destruction of assets and disruption of our business and operations. Acts of war or terrorism, or public health threats, may also injure our employees, cause loss of lives, disrupt our business network and destroy our markets. Any of these factors and other factors beyond our control could have an adverse effect on the overall business sentiment and environment, cause uncertainties in the regions where we conduct business, cause our business to suffer in ways that we cannot predict and materially and adversely impact our business, financial conditions and results of operations.

For example, in March 2020, the WHO categorized COVID-19 as a pandemic. COVID-19 continues to spread throughout the United States and other countries across the world, and the duration and severity of its effects are currently unknown. The spread of COVID-19 has impacted the global economy and has had an impact on our operations, including delays in our clinical trial activities. COVID-19 has resulted in significant governmental measures being implemented to control the spread of the virus, including quarantines, travel restrictions, social distancing and business shutdowns. We have taken precautionary measures intended to help minimize the risk of the virus to our employees, including temporarily requiring many employees to work remotely. For example, we have suspended non-essential travel worldwide for our

employees. Although we believe that COVID-19 has had a limited impact on our operations as of the date of this prospectus, we have experienced delays in the enrollment of patients in our clinical trials. For example, we have experienced a few months' delay in commencement of patient enrollment in Australia that was caused by COVID-19, which was not material to the Company. Our clinical trials could be further delayed due to government orders and site policies on account of the pandemic. Some patients may be unwilling or unable to travel to study sites, enroll in our studies or comply with clinical trial protocols if quarantines impede patient movement or interrupt healthcare services, which would delay our ability to conduct clinical trials or release clinical trial results and could delay our ability to obtain regulatory approval and commercialize our product candidates. The spread of an infectious disease, including COVID-19, may also result in the inability of our suppliers to source or deliver components or raw materials necessary for our clinical supply on a timely basis or at all. In addition, hospitals may reduce staffing and reduce or postpone certain treatments in response to the spread of an infectious disease. Such events may result in a period of business disruption and in reduced operations or doctors and medical providers may be unwilling to participate in our clinical trials, any of which could materially affect our business, financial condition and results of operations.

Further, as a result of the COVID-19 public health emergency, we may be required to develop and implement additional clinical trial policies and procedures based on new guidance and regulatory requirements promulgated by the FDA or other regulatory authorities. For example, the FDA issued guidance in March 2020, which the FDA subsequently updated, on conducting clinical trials during the pandemic, which describe a number of considerations for sponsors of clinical trials impacted by the pandemic. In June 2020, the FDA also issued a guidance on good manufacturing practice considerations for responding to COVID-19 infection in employees in drug products manufacturing, including recommendations for manufacturing controls to prevent contamination of drugs. Additional COVID-19 related guidance released by the FDA includes guidance addressing resuming normal drug and biologics manufacturing operations; manufacturing, supply chain, and inspections; and statistical considerations for clinical trials during the COVID-19 public health emergency. Further, infections and deaths related to COVID-19 are disrupting certain healthcare and healthcare regulatory systems globally. Such disruptions could divert healthcare resources away from, or materially delay review by, the FDA and comparable foreign regulatory agencies. It is unknown how long these disruptions could continue, were they to occur. Any elongation or de-prioritization of our clinical trials or delay in regulatory review resulting from such disruptions could materially adversely affect the development and study of our product candidates.

We continue to assess the impact that the COVID-19 pandemic may have on our ability to advance the testing, development and manufacturing of our product candidates, including as a result of adverse impacts on the research sites, service providers, vendors, or suppliers on whom we rely, or to raise financing to support the development of our product candidates. Additionally, temporarily requiring all employees to work remotely may induce absenteeism, disrupt our operations, increase the risk of a cybersecurity incident, create data accessibility concerns and make us more susceptible to communication disruptions. The COVID-19 pandemic has also caused volatility in the global financial markets and threatened a slowdown in the global economy, which may negatively affect our ability to raise additional capital on attractive terms or at all. No assurances can be given that this analysis will enable us to avoid part or all of any impact from the spread of COVID-19 or its consequences, including downturns in business sentiment generally or in our sector in particular. We cannot presently predict the scope and severity of any potential business shutdowns or disruptions, particularly in the event the current situation worsens, for example, with second or third waves of the pandemic, but if we or any of the third parties on whom we rely or with whom we conduct business, were to experience shutdowns or other business disruptions, our ability to conduct our business in the manner and on the timelines presently planned could be materially and adversely impacted.

The extent to which the COVID-19 pandemic or other epidemics or pandemics may impact our business will depend on future developments, which are highly uncertain and cannot be predicted, such as the duration of the pandemic, the severity of the COVID-19 pandemic or the effectiveness of actions to contain and treat the COVID-19 pandemic, particularly in the United States and other geographies where we or our third party suppliers, clinical trial sites, CROs and CMOs operate. We cannot presently predict the scope and severity of any potential business shutdowns or disruptions. If we or any of the third parties with whom we engage, however, were to experience shutdowns or other business disruptions, our ability to

conduct our business in the manner and on the timelines presently planned could be materially and negatively affected, which could have a material adverse impact on our business, our results of operations and financial condition.

***We are subject to changing law and regulations regarding regulatory matters, corporate governance and public disclosure that have increased both our costs and the risk of non-compliance.***

We are or will be subject to rules and regulations by various governing bodies, including, for example, once we become a public company, the U.S. Securities and Exchange Commission, or the SEC, which is charged with the protection of investors and the oversight of companies whose securities are publicly traded, and the various regulatory authorities in the Cayman Islands, Taiwan, the PRC and Australia, and to new and evolving regulatory measures under applicable law. Our efforts to comply with new and changing laws and regulations have resulted in and are likely to continue to result in, increased general and administrative expenses and a diversion of management time and attention from revenue-generating activities to compliance activities. Further, there could be unanticipated changes in existing regulatory requirements. Any failure to comply with ongoing regulatory requirements may significantly and adversely affect our ability to commercialize and generate revenues from our product candidates. If regulatory sanctions are applied or if regulatory approval is withdrawn, the value of our Company and our operating results will be adversely affected.

Moreover, because these laws, regulations and standards are subject to varying interpretations, their application in practice may evolve over time as new guidance becomes available. This evolution may result in continuing uncertainty regarding compliance matters and additional costs necessitated by ongoing revisions to our disclosure and governance practices. If we fail to address and comply with these regulations and any subsequent changes, we may be subject to penalty and our business may be harmed.

***We have granted, and will continue to grant, options and other types of awards under our equity incentive plans, which may result in increased share-based compensation expenses and dilution to our existing shareholders and holders of our ADSs.***

We have adopted the Belite Bio, Inc Amended and Restated Share Incentive Plan, or the 2020 Share Incentive Plan, and expect to adopt the 2022 Performance Incentive Plan for the purpose of granting share-based compensation awards to employees, directors and consultants to incentivize their performance and align their interests with ours. The 2022 Performance Incentive Plan is expected to become effective immediately prior to the completion of this offering. As of the date of this prospectus, options to purchase a total of 1,982,561 ordinary shares have been granted and are outstanding under the 2020 Share Incentive Plan. As of the date of this prospectus, no award has been granted or is outstanding under the 2022 Performance Incentive Plan. See “Management — Share Incentive Plans.”

We believe the granting of share-based compensation is of significant importance to our ability to attract and retain key personnel and employees, and we will continue to grant share-based compensation to employees in the future. As a result, our expenses associated with share-based compensation may increase, which may have an adverse effect on our results of operations. Furthermore, the granting of share-based compensation will lead to dilution of our existing shareholders, including any holders of our ADSs. We may re-evaluate the vesting schedules, lock-up period, exercise price or other key terms applicable to the grants under our currently effective equity incentive plans from time to time. If we choose to do so, we may experience substantial change in our share-based compensation charges in the reporting periods following this offering.

***If we fail to comply with certain U.S. and foreign anti-corruption, anti-money laundering, export control, sanctions and other trade laws and regulations, we could be subject to serious consequences and significant expenses that could have a material adverse effect on our business, financial condition and results of operations, and our reputation may be harmed.***

Among other matters, U.S. and foreign anti-corruption, anti-money laundering, export control, sanctions and other trade laws and regulations, collectively, Trade Laws, prohibit companies and their employees, agents, clinical research organizations, legal counsel, accountants, consultants, contractors and other partners from authorizing, promising, offering, providing, soliciting or receiving, directly or indirectly,



corrupt or improper payments or anything else of value to or from recipients in the public or private sector. In particular, the FCPA generally prohibits us from making payments to non-U.S. officials for the purpose of obtaining or retaining business. We are also subject to the anti-bribery and corruption laws of other jurisdictions. We have direct or indirect interactions with officials and employees of government agencies or government-affiliated hospitals, universities and other organizations. We also have significant non-U.S. activities that we expect to increase in time. We plan to engage third parties for clinical trials and/or to obtain necessary permits, licenses, patent registrations and other regulatory approvals and we can be held liable for the corrupt or other illegal activities of our personnel, agents or partners, even if we do not explicitly authorize or have prior knowledge of such activities. Additionally, in many other countries, the healthcare providers who prescribe pharmaceuticals are employed by their government, and the purchasers of pharmaceuticals are government entities; therefore, our dealings with these prescribers and purchasers are subject to regulation under the Trade Laws.

***Our business may be exposed to foreign exchange risks.***

We operate internationally and conduct clinical trials in multiple jurisdictions and thus we have expenses denominated in local currencies in multiple jurisdictions in connection with, among other things, our sponsored clinical trials, purchase of drug product for our clinical trials, process development and the prosecution and maintenance of our intellectual property portfolio. As a result, we are exposed to foreign currency exchange risk, as our results of operations and cash flows are subject to fluctuations in foreign currency exchange rates. In accordance with our business decisions, our exposure to this type of risk could change depending on:

- the currencies chosen when agreements are signed, such as licensing agreements, or co-marketing or co-development agreements;
- the location of clinical trials on product candidates; and
- our policy for insurance coverage.

Should any of these risks materialize, this could have a material adverse effect on our business, prospects, financial condition and results of operations.

***Changes in the political and economic policies of the Chinese government or in relations between China and the United States may materially and adversely affect our business, financial condition, results of operations and the market price of our ADSs.***

We currently have no operations in China although we have established a subsidiary in each of Hong Kong and China. However, we may in the future elect to conduct clinical trials for our product candidates in China or expand our operations into China (see “Business” beginning on page 112 for our current plans for future clinical trials), and therefore our financial condition and results of operations may be affected by economic, political and legal developments in China. The PRC economy differs from the economies of most developed countries in many respects, including the extent of government involvement, level of development, growth rate, control of foreign exchange and allocation of resources. Although the PRC government has implemented measures emphasizing the utilization of market forces for economic reform, the reduction of state ownership of productive assets, and the establishment of improved corporate governance in business enterprises, a substantial portion of productive assets in China is still owned by the government. In addition, the PRC government continues to play a significant role in regulating industrial development by imposing industrial policies, and change of enforcement practice of such rules and policies can occur quickly with little advance notice. The PRC government also exercises significant control over China’s economic growth by allocating resources, controlling payment of foreign currency-denominated obligations, setting monetary policy, regulating financial services and institutions and providing preferential treatment to particular industries or companies.

While the PRC economy has experienced significant growth in the past four decades, growth has been uneven, both geographically and among various sectors of the economy. The PRC government has implemented various measures to encourage economic growth and guide the allocation of resources. Some of these measures may benefit the overall PRC economy, but may also have a negative effect on us. Our



business, financial condition and results of operations could be materially and adversely affected by government control over capital investments or changes in tax regulations that are applicable to us.

In addition, the PRC government had, in the past, implemented certain measures, including interest rate increases, to control the pace of economic growth. These measures may cause decreased economic activity in China, which may adversely affect our business and results of operations. More generally, if the business environment in China deteriorates from the perspective of domestic or international investment, our business in China may also be adversely affected. In July 2021, the Chinese government provided new guidance on strengthening supervision on China-based companies raising capital outside of China. In addition, the Chinese government further issued certain drafts of regulations regarding internet data security which require certain China-based data processors to conduct a cyber security review before their overseas listing. In light of such developments, the SEC has imposed enhanced disclosure requirements on China-based companies seeking to register securities with the SEC. Although we believe we are not regarded as such data processors currently, as we expect to expand our operations in China (see “Business” beginning on page 112 for our current plans for future clinical trials), any future Chinese, U.S. or other rules and regulations that place restrictions on capital raising or other activities by companies with extensive operations in China could adversely affect our business and results of operations. If the business environment in China deteriorates from the perspective of domestic or international investment, or if relations between China and the United States or other governments deteriorate, the Chinese government may intervene with our operations and our business in China and United States, as well as the market price of our ADSs, may also be adversely affected.

***Changes in U.S. and Chinese regulations may adversely impact our business, our operating results, our ability to raise capital and the market price of our ADSs.***

The U.S. government has made statements and taken certain actions that led to changes to United States and international relations, and will impact companies with connections to the United States or China, including imposing several rounds of tariffs affecting certain products manufactured in China, imposing certain sanctions and restrictions in relation to China and issuing statements indicating enhanced review of companies with significant China-based operations. It is unknown whether and to what extent new legislation, executive orders, tariffs, laws or regulations will be adopted, or the effect that any such actions would have on companies with significant connections to the United States or to China, our industry or on us. We conduct clinical activities and have business operations both in the United States and China. Any unfavorable government policies on cross-border relations and/or international trade, including increased scrutiny on companies with significant China-based operations, capital controls or tariffs, may affect the competitive position of our drug products, the hiring of scientists and other research and development personnel, the demand for our drug products, the import or export of raw materials in relation to drug development, our ability to raise capital, the market price of our ADSs or prevent us from selling our drug products in certain countries. Furthermore, the SEC has issued statements primarily focused on companies with significant China-based operations. For example, on July 30, 2021, Gary Gensler, Chairman of the SEC, issued a Statement on Investor Protection Related to Recent Developments in China, pursuant to which Chairman Gensler stated that he has asked the SEC staff to engage in targeted additional reviews of filings for companies with significant China-based operations. The statement also addressed risks inherent in companies with variable interest entities (“VIEs”) structures. We do not have a VIE structure and are not in a restricted foreign investment industry. However, it is possible that the Company’s periodic reports and other filings with the SEC may be subject to enhanced review by the SEC and this additional scrutiny could affect our ability to effectively raise capital in the United States.

In response to the SEC’s July 30, 2021 statement, the China Securities Regulatory Commission (the “CSRC”) announced on August 1, 2021, that “it is our belief that Chinese and U.S. regulators shall continue to enhance communication with the principle of mutual respect and cooperation, and properly address the issues related to the supervision of China-based companies listed in the U.S. so as to form stable policy expectations and create benign rules framework for the market.” While the CSRC will continue to collaborate “closely with different stakeholders including investors, companies, and relevant authorities to further promote transparency and certainty of policies and implementing measures,” it emphasized that it “has always been open to companies’ choices to list their securities on international or domestic markets in compliance with relevant laws and regulations.”

If any new legislation, executive orders, tariffs, laws and/or regulations are implemented, if existing trade agreements are renegotiated, if the U.S. or Chinese governments take retaliatory actions due to the recent U.S.-China tension or if the Chinese government exerts more oversight and control over securities offerings that are conducted in the United States, such changes could have an adverse effect on our business, financial condition and results of operations, our ability to raise capital and the market price of our ADSs.

***We currently have no operations in China although we have established a subsidiary in each of Hong Kong and China. However, due to the extraterritorial reach (the so-called “long arm provisions”) under the current PRC laws and regulations, the Chinese government may intervene in or influence our operations at any time, which could result in a material change in our operations and significantly and adversely impact the value of our ADSs.***

The Chinese government has significant oversight and discretion over the conduct of our business and may intervene or influence our operations as the government deems appropriate to further regulatory, political and societal goals. The Chinese government has recently published new policies that significantly affected certain industries such as the education and internet industries, and we cannot rule out the possibility that it will in the future release regulations or policies regarding our industry that could require us to seek permission from Chinese authorities to continue to operate our business adversely affect our business, financial condition and results of operations. Furthermore, recent statements made by the Chinese government have indicated an intent to increase the government’s oversight and control over offerings of companies with significant operations in China that are to be conducted in foreign markets, as well as foreign investment in China-based issuers. Although as of the date of this prospectus, we do not expect to be materially affected by the foregoing statements, any such action, once taken by the Chinese government, could significantly limit or completely hinder our ability to offer or continue to offer ADSs to our investors, and could cause the value of our ADSs to significantly decline or become worthless.

***In the event that we elect to carry out clinical trials in China and/or to expand our operations into China in the future, we will be subject to changing legal and regulatory requirements in the PRC pharmaceutical industry, and new laws, rules and regulations promulgated by the PRC government may adversely affect our profitability or impose additional compliance burdens on us.***

As required under the NMPA regulations, we established a subsidiary in China with an aim to serve as the applicant for the planned clinical trials relating to our drug candidates in China. Our PRC subsidiary currently has no substantive operations, and no clinical trial for our drug candidates may be conducted in China until relevant approvals from the NMPA are obtained. There is no indication as to whether the NMPA would approve our proposed application for clinical trial or when such NMPA approval could be obtained. In addition, our PRC subsidiary is not required to obtain any specific license or permits other than the NMPA approval to conduct clinical trials in China. In the event that we elect to carry out clinical trials in China after relevant NMPA approval is obtained (see “Business” beginning on page [112](#) for our current plans for future clinical trials) and/or expand our operations into China in the future, we would be required to comply with relevant PRC laws and regulations in relation to our clinical trials and operations.

The PRC pharmaceutical industry is subject to extensive government regulation and supervision as well as monitoring by various government authorities. In particular, the current regulatory framework addresses substantially all aspects of a pharmaceutical company’s operations, including approval, production, licensing, certification requirements and procedures, periodic renewal and reassessment processes, registration of new drugs, quality control, pricing of pharmaceutical products and environmental protection. There can be no assurance that the legal framework, licensing and certification requirements or enforcement trends in our industry will not change in a manner that may result in increased costs of compliance, or that we will be successful in responding to such changes. We may also be subject to the risk of adverse changes to favorable governmental policies, and the introduction of unfavorable governmental policies on the pharmaceutical industry. The costs we incur to comply with these laws and regulations may materially increase our total costs and decrease any potential profits. Any violation of these laws, rules or regulations or our failure to obtain any required approvals or permits may result in substantial fines, criminal sanctions, revocations of operating permits, shutdown of our facilities and obligations to take rectification measures.

Other than the industry specific laws and regulations that are applicable to the biotechnology or pharmaceutical companies, we may also be subject to laws and regulations promulgated or implemented by

other regulatory authorities in China concerning cyber security and data protection. Regulatory authorities in China have implemented and may consider to implement additional legislation concerning data protection. For example, China's Cyber Security Law, which became effective in June 2017, created China's first national-level data protection for "network operators," which may include all organizations in China that provide services over the Internet or another information network. Various regulations, guidelines and other measures are expected to be adopted under the umbrella of the Cyber Security Law. Drafts of some of these measures have now been published, including the draft rules on cross-border transfers published by the China Cyberspace Administration in 2017 and 2019, which may, upon enactment, require security review before transferring human health-related data out of China. In addition, the Standing Committee of the National People's Congress of the People's Republic of China, or SCNPC, promulgated the Data Security Law of the People's Republic of China, or the Data Security Law, on June 10, 2021, which became effective on September 1, 2021. The Data Security Law imposes data security and privacy obligations on entities and individuals carrying out data processing activities, and introduces a data classification and hierarchical protection system. A similar security assessment mechanism was also included in the Personal Information Protection Law, or the Personal Information Protection Law, which was promulgated in August 2021 and became effective on November 1, 2021, for the Chinese government to supervise certain cross-border transfers of personal information.

Under the Cyber Security Law and Data Security Law, in the event that we elect to carry out clinical trials in China and/or to expand our operations into China in the future, (i) we may be required to establish and maintain a comprehensive data and network security management system that will enable us to monitor and respond appropriately to data security and network security risks; (ii) we may need to classify and take appropriate measures to address risks created by our data processing activities and use of networks; and (iii) we may be obligated to notify affected individuals and appropriate Chinese regulators of and respond to any data security and network security incidents. Establishing and maintaining such systems takes substantial time, effort and cost, and we may not be able to establish and maintain such systems fully as needed to ensure compliance with our legal obligations. Despite our investment, such systems may not fully guard us or enable us to appropriately respond to or mitigate all data security and network security risks or incidents we face. We may also be required to disclose to regulators business-sensitive or network security-sensitive details regarding our processing of important data, and may need to pass the government security review or obtain government approval in order to share important data with offshore recipients, which can include foreign licensors, or share data stored in China with judicial and law enforcement authorities outside of China. If judicial and law enforcement authorities outside China require us to provide data stored in China, and disclosing such data may be subject to security review or prior approval by relevant PRC government authorities, we may not be able to meet the foreign authorities' requirements. The potential conflicts in legal obligations could have adverse impact on our operations in and outside of China.

Furthermore, on December 28, 2021, the Cybersecurity Administration of China, China's highest cyberspace regulator, and other twelve authorities of the PRC jointly issued the amended Cybersecurity Review Measures, or the Amended Cybersecurity Review Measures, which became effective on February 15, 2022. Under the Amended Cybersecurity Review Measures, the scope of entities required to undergo cybersecurity review to assess national security risks that arise from data processing activities would be expanded to include all critical information infrastructure operators who purchase network products and services and all data processors carrying out data processing activities that affect or may affect national security. In addition, the Amended Cybersecurity Review Measures requires that all such entities that maintain or store the personal information of more than 1 million users and undertake a public listing of securities in a foreign country would be required to pass cybersecurity review. To comply with these requirements, maintaining local data centers in China, conducting security assessments or obtaining the requisite approvals from the Chinese government for the transmission outside of China of such controlled information and data could significantly increase our operating costs or cause delays or disruptions in our business operations in and outside China.

***There are uncertainties regarding the interpretation and enforcement of PRC laws, rules and regulations.***

Certain of our clinical research and development activities are expected to be supervised by relevant regulatory authorities in China if we elect to conduct clinical trials in China for our product candidates in the future (see "Business" beginning on page [112](#) for our current plans for future clinical trials). The PRC legal

system is a civil law system based on written statutes and, unlike the common law system, prior court decisions can only be cited as reference and have limited precedential value. Additionally, written statutes in the PRC are often principle-oriented and require detailed interpretations by the enforcement bodies to further apply and enforce such laws. Since 1979, the PRC government has developed a comprehensive system of laws, rules and regulations in relation to economic matters, such as foreign investment, corporate organization and governance, commerce, taxation and trade. However, the interpretation and enforcement of these laws, rules and regulations involve uncertainties and may not be as consistent or predictable as in other more developed jurisdictions. As these laws and regulations are continually evolving in response to changing economic and other conditions, and because of the limited volume of published cases and their non-binding nature, any particular interpretation of PRC laws and regulations may not be definitive. Moreover, we cannot predict the effect of future developments in the PRC legal system and regulatory structure. Such unpredictability towards our contractual, property and procedural rights as well as our rights licensed, approved or granted by the competent regulatory authority could adversely affect our business and impede our ability to continue our operations. In addition, the PRC legal system is based in part on government policies and internal rules, some of which are not published on a timely basis, if at all, and which may have a retroactive effect. Hence, we may not be aware of violation of these policies and rules until after such violation has occurred. Further, the legal protections available to us and our investors under these laws, rules and regulations may be limited.

In addition, any administrative or court proceedings in China may be protracted, resulting in substantial costs and diversion of resources and management attention. Since PRC administrative and court authorities have significant discretion in interpreting and implementing statutory and contractual terms, it may be more difficult to evaluate the outcome of administrative and court proceedings and the level of legal protection we enjoy than in more developed legal systems. These uncertainties may impede our ability to enforce various contracts we have entered into and could materially and adversely affect our business, financial condition and results of operations.

***We may be restricted from transferring our scientific data abroad.***

On March 17, 2018, the General Office of the PRC State Council promulgated the Measures for the Management of Scientific Data, or the Scientific Data Measures, which provide a broad definition of scientific data and relevant rules for the management of scientific data. Enterprises in China must seek governmental approval before any scientific data involving a state secret may be transferred abroad or to foreign parties. Further, any researcher conducting research funded, at least in part, by the PRC government is required to submit relevant scientific data for management by the entity to which such researcher is affiliated before such data may be published in any foreign academic journal. Currently, as the term “state secret” is not clearly defined, there is no assurance that we can always obtain relevant approvals for sending scientific data (such as the results of our preclinical studies or clinical trials conducted within China in the future) abroad, or to our foreign collaborators in China.

If we are unable to obtain the necessary approvals in a timely manner, or at all, our research and development of product candidates in the future may be hindered, which may materially and adversely affect our business, results of operations, financial conditions and prospects. If relevant government authorities consider the transmission of our scientific data to be in violation of the requirements under the Scientific Data Measures, we may be subject to specific administrative penalties imposed by those government authorities.

**Risks Related to Our Reliance on Third Parties**

***As we rely on third parties to conduct our preclinical studies, clinical trials, contract manufacture drug substances and drug products, and provide other important services related to product development, regulatory submissions, and commercialization, if we lose our relationships with these third parties or if they do not successfully carry out their contractual duties, comply with applicable laws, or meet expected deadlines, we may not be able to obtain regulatory approval for or commercialize our product candidates and our business could be substantially harmed.***

We have relied on and plan to continue to rely on third-party CROs to monitor and manage data for some of our ongoing preclinical studies and clinical trials. We rely on these parties for the execution of our

preclinical studies and clinical trials, and control only certain aspects of their activities. Nevertheless, we are responsible for ensuring that each of our studies is conducted in accordance with the applicable protocol and legal, regulatory and scientific standards, and our reliance on the CROs does not relieve us of our regulatory responsibilities.

Our CROs have the right to terminate their agreements with us in the event of an unrectified material breach. If any of our relationships with our third-party CROs is terminated, we may not be able to (i) enter into arrangements with alternative CROs or do so on commercially reasonable terms or (ii) meet our desired clinical development timelines. In addition, there is a natural transition period when a new CRO commences work, and the new CRO may not provide the same type or level of services as the original provider and data from our clinical trials may be compromised as a result. There is also a need for relevant technology to be transferred to the new CRO, which may take time and further delay our development timelines.

Except for remedies available to us under our agreements with our CROs, we cannot control whether or not our CROs devote sufficient time and resources to our ongoing clinical, nonclinical and preclinical studies. If our CROs do not successfully carry out their contractual duties or obligations or meet expected deadlines or if the quality or accuracy of the clinical data they obtain is compromised due to their failure to adhere to our clinical protocols, the impacts of COVID-19 on their operations, regulatory requirements or for other reasons, our clinical trials may be extended, delayed or terminated and we may not be able to obtain regulatory approval for or successfully commercialize our product candidates. As a result, our results of operations and the commercial prospects for our product candidates would be harmed and our costs could increase. In turn, our ability to generate revenues could be delayed or compromised.

Because we rely on third parties, our internal capacity to perform these functions is limited. Outsourcing these functions involves certain risks that third parties may not perform to our standards, may not produce results in a timely manner or may fail to perform at all. In addition, the use of third-party service providers requires us to disclose our proprietary information to these third parties, which could increase the risk that such information will be misappropriated. We currently have a limited number of employees, which limits the internal resources we have available to identify and monitor our third-party service providers. To the extent we are unable to identify and successfully manage the performance of third-party service providers in the future, our business may be adversely affected. Though we carefully manage our relationships with our CROs, there can be no assurance that we will not encounter similar challenges or delays in the future, and such challenges or delays could have a material adverse impact on our business, financial condition and prospects.

***As we rely on third parties to conduct our preclinical studies and clinical trials, our business could be harmed if those third parties fail to comply with the applicable regulatory requirements.***

We and our CROs are required to comply with cGCP, current good laboratory practices, or cGLP, and other regulatory regulations and guidelines enforced by the FDA, the TGA, the NMPA, the EMA, the International Conference on Harmonization, or ICH, and comparable foreign regulatory authorities for all of our product candidates in clinical development. Regulatory authorities enforce these cGCP, cGLP or other regulatory requirements through periodic inspections of study sponsors, investigators and study sites. If we or any of our CROs fail to comply with applicable cGCP, cGLP or other regulatory requirements, the relevant data generated in our preclinical studies and clinical trials may be deemed unreliable and the FDA, the TGA, the NMPA, the EMA or other comparable regulatory authorities may require us to perform additional clinical trials before approving our marketing applications. There can be no assurance that upon inspection by a given regulatory authority, such regulatory authority will determine that any of our clinical trials complies with cGCP requirements. In addition, our clinical trials must be conducted with product candidates or products produced under cGMP requirements. Failure to comply with these regulations may require us to repeat preclinical studies and clinical trials, which would delay the regulatory approval process.

***We rely on third parties to supply the drug raw materials for our manufacturing activities. Lack of availability or significant increases in cost of such drug raw materials could harm our business.***

The manufacture of biopharmaceutical products is complex and requires significant expertise and capital investment, including the development of advanced manufacturing techniques and process controls. Currently, our drug raw materials for our manufacturing activities are supplied by multi-source suppliers

and we entered into long-term capacity arrangements with one of our suppliers. We believe our suppliers have sufficient capacity to meet our demands for drug materials. In addition, we believe that adequate alternative sources for such supplies exist. However, there is a risk that, if supplies are interrupted or if the costs of such drug materials were to significantly increase, our business would be materially harmed. For example, the COVID-19 pandemic could have a broad impact on the production and supplies of active ingredients or other raw materials and result in a potential shortage of supply. If we or our third-party manufacturers experience a shortage in supply of active ingredients or other raw materials, whether due to COVID-19 or otherwise, we may not be able to continue to supply adequate levels of our drugs to our customers, which would have a negative impact on our business and results of operations.

***We expect to seek to establish collaborations and, if we are not able to establish them on commercially reasonable terms, we may have to alter our development and commercialization plans.***

We may form or seek strategic alliances, create joint ventures or collaborations, or enter into licensing arrangements with third parties that we believe will complement or augment our development and commercialization efforts with respect to our product candidates and any future product candidates that we may develop. Any of these relationships may require us to incur recurring or non-recurring expenses and other charges, increase our near and long-term expenditures, issue securities that dilute the value of our ADSs, or disrupt our management and business. In addition, we face significant competition in seeking appropriate strategic partners and the negotiation process is time-consuming and complex. Moreover, we may not be successful in our efforts to establish a strategic collaboration or other alternative arrangements for our product candidates because they may be deemed to be at too early a stage of development for collaborative effort and third parties may not view our product candidates as having the requisite potential to demonstrate safety and efficacy. If and when we collaborate with a third party for the development and commercialization of a product candidate, we can expect to relinquish some or all of the control over the future success of that product candidate to the third party.

Further, collaborations involving our product candidates are subject to additional risks, which include, but are not limited to, the following:

- collaborators may have significant discretion in determining the efforts and resources that they will apply to a collaboration;
- collaborators may not pursue the development and commercialization of our product candidates or may elect not to continue or renew the development or commercialization programs based on clinical trial results, change in their strategic focus due to the acquisition of competitive drugs, increased competition, availability of funding, or other external factors, such as a business combination that diverts resources or creates competing priorities;
- collaborators may delay clinical trials, provide insufficient funding for a clinical trial, discontinue a clinical trial, repeat or conduct new clinical trials, or require a new formulation of a product candidate for clinical testing;
- collaborators could independently develop, or develop with third parties, drugs that compete directly or indirectly with our product candidates or future drugs;
- collaborators with marketing and distribution rights to one or more of our product candidates or future drugs may not commit sufficient resources to their marketing and distribution;
- collaborators may not properly maintain or defend our intellectual property rights or may use our intellectual property or proprietary information in a way that gives rise to actual or threatened litigation that could jeopardize or invalidate our intellectual property or proprietary information or expose us to potential liability;
- collaborators may not always be cooperative or responsive in providing their services in a clinical trial;
- disputes may arise between us and a collaborator that cause a delay or termination of the research, development or commercialization of our product candidates, or that result in costly litigation or arbitration that diverts management attention and resources;

- collaborations may be terminated and, if terminated, may result in a need for additional capital to pursue further development or commercialization of the applicable product candidates;
- collaborators may own or co-own intellectual property covering our product candidates or future drugs that results from our collaborating with them, and in such cases, we would not have the exclusive right to commercialize such intellectual property; and
- we may not be able to receive agreed development fees, royalties or milestone payments we expected when seeking collaborations.

As a result, if we enter into collaboration agreements or license our drugs, we may not be able to realize the benefit of such transactions if we are unable to successfully integrate these collaborations or licenses with our existing operations and company culture, which could delay our timelines or otherwise adversely affect our business.

If we are unable to reach agreements with suitable collaborators on a timely basis, on acceptable terms, or at all, we may have to curtail the development of a product candidate, reduce or delay its development program or one or more of our other development programs, delay its potential commercialization or reduce the scope of any sales or marketing activities, or increase our expenditures and undertake development or commercialization activities at our own expense. If we elect to fund and undertake development or commercialization activities on our own, we may need to obtain additional expertise and additional capital, which may not be available to us on acceptable terms or at all. If we fail to enter into collaborations and do not have sufficient funds or expertise to undertake the necessary development and commercialization activities, we may not be able to further develop our product candidates or bring them to market and generate product sales revenue, which would harm our business, financial condition, results of operations and prospects.

***Collaborations are complex and time-consuming to negotiate and document. Further, there have been a significant number of recent business combinations among large pharmaceutical companies that have resulted in a reduced number of potential future collaborators.***

Any collaboration agreements that we enter into in the future may contain restrictions on our ability to enter into potential collaborations or to otherwise develop specified product candidates. We may not be able to negotiate collaborations on a timely basis, on acceptable terms, or at all. If we are unable to do so, we may have to curtail the development of the product candidate for which we are seeking to collaborate, reduce or delay its development program or one or more of our other development programs, delay its potential commercialization or reduce the scope of any sales or marketing activities, or increase our expenditures and undertake development or commercialization activities at our own expense.

#### **Risks Related to This Offering and Our ADSs**

***Although the audit report included in this prospectus is issued by an independent registered public accounting firm that is subject to inspections by the Public Company Accounting Oversight Board, or the PCAOB, and has been inspected by the PCAOB on a regular basis, there is no guarantee that future audit reports will be prepared by auditors or their international affiliates in jurisdictions where the PCAOB is able to fully inspect their work, and as such, future investors may be deprived of such inspections, which could result in limitations or restrictions to our access of the U.S. capital markets. Furthermore, trading in our securities may be prohibited under the Holding Foreign Companies Accountable Act, or the HFCAA, or the Accelerating Holding Foreign Companies Accountable Act if the SEC subsequently determines our audit work is performed by auditors that the PCAOB is unable to inspect or investigate completely, and as a result, U.S. national securities exchanges, such as the Nasdaq, may determine to delist our securities. Furthermore, on June 22, 2021, the U.S. Senate passed the Accelerating Holding Foreign Companies Accountable Act, which, if enacted, would amend the HFCAA and require the SEC to prohibit an issuer's securities from trading on any U.S. stock exchanges if its auditor is not subject to PCAOB inspections for two consecutive years instead of three, as currently provided by the HFCAA.***

Our auditor, Friedman LLP, an independent registered public accounting firm with the PCAOB, is required under the laws of the United States to undergo regular inspections by the PCAOB to assess their compliance with the laws of the United States and professional standards. Although we have a subsidiary



within the PRC, a jurisdiction where the PCAOB is currently unable to conduct inspections without the approval of the Chinese government authorities, our auditor is currently subject to inspection by the PCAOB and has been inspected by the PCAOB on a regular basis. However, recent developments would add uncertainties to our offering, and we cannot assure you whether Nasdaq or regulatory authorities would apply additional and more stringent criteria to us after considering the effectiveness of our auditor's audit procedures and quality control procedures, adequacy of personnel and training, or sufficiency of resources, geographic reach or experience as it relates to the audit of our financial statements.

Inspections of an independent registered public accounting firm conducted by the PCAOB outside China have at times identified deficiencies in those auditors' audit procedures and quality control procedures, which may be addressed as part of the inspection process to improve future audit quality. The lack of PCAOB inspections of audit work undertaken in China prevents the PCAOB from regularly evaluating auditors' audits and their quality control procedures. As a result, to the extent that any component of our auditor's work papers are or become located in China, such work papers will not be subject to inspection by the PCAOB. As a result, investors would be deprived of such PCAOB inspections, which could result in limitations or restrictions to our access of the U.S. capital markets.

As part of a continued regulatory focus in the United States on access to audit and other information currently protected by national law, in particular the law in China, in June 2019, a bipartisan group of lawmakers introduced bills in both houses of the U.S. Congress which, if passed, would require the SEC to maintain a list of issuers for which PCAOB is not able to inspect or investigate the audit work performed by a foreign public accounting firm completely. The proposed Ensuring Quality Information and Transparency for Abroad-Based Listings on our Exchanges (EQUITABLE) Act prescribes increased disclosure requirements for these issuers and, beginning in 2025, the delisting from U.S. national securities exchanges such as the Nasdaq of issuers included on the SEC's list for three consecutive years. It is unclear if this proposed legislation will be enacted. Furthermore, there have been recent deliberations within the U.S. government regarding potentially limiting or restricting China-based companies from accessing U.S. capital markets.

On May 20, 2020, the U.S. Senate passed the Holding Foreign Companies Accountable Act, or the HFCAA, which includes requirements for the SEC to identify issuers whose audit work is performed by auditors that the PCAOB is unable to inspect or investigate completely because of a restriction imposed by a non-U.S. authority in the auditor's local jurisdiction. The U.S. House of Representatives passed the HFCAA on December 2, 2020, and the HFCAA was signed into law on December 18, 2020. Additionally, in July 2020, the U.S. President's Working Group on Financial Markets issued recommendations for actions that can be taken by the executive branch, the SEC, the PCAOB or other federal agencies and department with respect to Chinese companies listed on U.S. stock exchanges and their audit firms, in an effort to protect investors in the United States. In response, on November 23, 2020, the SEC issued guidance highlighting certain risks (and their implications to U.S. investors) associated with investments in China-based issuers and summarizing enhanced disclosures the SEC recommends China-based issuers make regarding such risks. On March 24, 2021, the SEC adopted interim final rules relating to the implementation of certain disclosure and documentation requirements of the HFCAA. A company will be required to comply with these rules if the SEC identifies it as having a "non-inspection" year (as defined in the interim final rules) under a process to be subsequently established by the SEC. The SEC is assessing how to implement other requirements of the HFCAA, including the listing and trading prohibition requirements described above.

Under the HFCAA, our securities may be prohibited from trading on the Nasdaq or other U.S. stock exchanges if our auditor is not inspected by the PCAOB for three consecutive years, and this ultimately could result in our ADSs being delisted. Furthermore, on June 22, 2021, the U.S. Senate passed the Accelerating Holding Foreign Companies Accountable Act, which, if enacted, would amend the HFCAA and require the SEC to prohibit an issuer's securities from trading on any U.S. stock exchanges if its auditor is not subject to PCAOB inspections for two consecutive years instead of three.

On September 22, 2021, the PCAOB adopted a final rule implementing the HFCAA, which provides a framework for the PCAOB to use when determining, as contemplated under the HFCAA, whether the Board is unable to inspect or investigate completely registered public accounting firms located in a foreign jurisdiction because of a position taken by one or more authorities in that jurisdiction.



While we understand that there has been dialogue among the China Securities Regulatory Commission, or the CSRC, the SEC and the PCAOB regarding the inspection of PCAOB-registered accounting firms in China, there can be no assurance that we will be able to comply with requirements imposed by U.S. regulators. Delisting of our ADSs would force holders of our ADSs to sell their ADSs or convert them into our Ordinary Shares. The market price of our ADSs could be adversely affected as a result of anticipated negative impacts of these executive or legislative actions upon, as well as negative investor sentiment towards, companies with significant operations in China that are listed in the United States, regardless of whether these executive or legislative actions are implemented and regardless of our actual operating performance.

***Because our initial public offering price is substantially higher than our net tangible book value per share, you will experience immediate and substantial dilution.***

If you purchase ADSs in this offering, you will pay more for your ADSs than the amount paid by our existing shareholders for their ordinary shares on a per ADS basis. As a result, you will experience immediate and substantial dilution of approximately \$            per ADS (assuming that no outstanding options to acquire ordinary shares are exercised), representing the difference between (i) the initial public offering price of \$            per ADS, and (ii) our pro forma as adjusted net tangible book value per ADS as of \$           , after giving effect to our sale of the ADSs offered in this offering. In addition, you may experience further dilution to the extent that our ordinary shares are issued upon the exercise of share options. See “Dilution” for a more complete description of how the value of your investment in the ADSs will be diluted upon completion of this offering.

***If we fail to establish and maintain proper internal controls over financial reporting, our ability to produce accurate financial statements or comply with applicable regulations could be impaired.***

Pursuant to Section 404 of the Sarbanes-Oxley Act, reporting companies are generally required to file a report by their management on such company’s internal control over financial reporting, including an attestation report on internal control over financial reporting issued by the company’s independent registered public accounting firm. However, while we remain an emerging growth company, we will not be required to include an attestation report on internal control over financial reporting issued by our independent registered public accounting firm. The presence of material weaknesses in internal control over financial reporting could result in financial statement errors which, in turn, could lead to errors in our financial reports and/or delays in our financial reporting, which could require us to restate our operating results. We might not identify one or more material weaknesses in our internal controls in connection with evaluating our compliance with Section 404 of the Sarbanes-Oxley Act. In order to maintain and improve the effectiveness of our disclosure controls and procedures and internal controls over financial reporting, we will need to expend significant resources and provide significant management oversight. Implementing any appropriate changes to our internal controls may require specific compliance training of our directors and employees, entail substantial costs in order to modify our existing accounting systems, take a significant period of time to complete and divert management’s attention from other business concerns. These changes may not, however, be effective in maintaining the adequacy of our internal control.

If we are unable to conclude that we have effective internal controls over financial reporting, investors may lose confidence in our operating results, the price of the ADSs could decline and we may be subject to litigation or regulatory enforcement actions. In addition, if we are unable to meet the requirements of Section 404 of the Sarbanes-Oxley Act, the ADSs may not be able to remain listed on Nasdaq Capital Market.

***Our corporate actions are substantially controlled by our directors and executive officers, who can exert significant influence over important corporate matters, which may reduce the price of the ADSs and deprive you of an opportunity to receive a premium for your ADSs.***

As of the date of this prospectus and on an as-converted basis, the chairman of the board of directors, Dr. Lin, beneficially owned approximately 13.61% of our outstanding ordinary shares and our directors and executive officers beneficially owned approximately 18.37% of our outstanding ordinary shares, collectively. These shareholders, if acting together, could exert substantial influence over matters such as electing directors and approving material mergers, acquisitions, strategic collaborations or other business combination transactions. This concentration of ownership may also discourage, delay or prevent a change in control of

our Company, which could have the dual effect of depriving our shareholders of an opportunity to receive a premium for their ordinary shares as part of a sale of our Company and reducing the price of the ADSs. These actions may be taken even if they are opposed by our other shareholders, including the holders of the ADSs. In addition, these persons could divert business opportunities away from us to themselves or others.

***As a result of our principal shareholder, Lin Bioscience International Ltd.'s significant share ownership position in the Company, the company is able to influence corporate matters and conflict of interest may arise between our principal shareholder and us.***

As of the date of this prospectus and on an as-converted basis, our principal shareholder, Lin Bioscience International Ltd., beneficially owned approximately 76.97% of our outstanding ordinary shares. As a result of significant share ownership position in our Company, our principal shareholder could exert substantial influence over matters such as electing directors and approving material mergers, acquisitions, strategic collaborations or other business combination transactions. This concentration of ownership may also discourage, delay or prevent a change in control of our Company, which could have the dual effect of depriving our shareholders of an opportunity to receive a premium for their ordinary shares as part of a sale of our Company and reducing the price of the ADSs. These actions may be taken even if they are opposed by our other shareholders, including the holders of the ADSs. In addition, these persons could divert business opportunities away from us to themselves or others.

Conflicts of interest may arise between our principal shareholder and us in a number of areas relating to our ongoing relationships. Our financial contribution to our principal shareholder was not material during the periods presented in this prospectus, and our principal shareholder may from time to time make strategic decisions that it believes are in the best interests of its business as a whole, which may be different from the decisions that we would have made on our own. Our principal shareholder's decisions with respect to us or our business may favor our principal shareholder and therefore our principal shareholder, which may not necessarily be aligned with our interests and the interests of our other shareholders. Our principal shareholder may make decisions, or suffer adverse trends, that may disrupt or discontinue our collaborations with our principal shareholder. Although we will become a stand-alone public company upon the completion of this offering and will have an audit committee, consisting of independent non-executive directors, to review and approve all proposed related party transactions including those between our principal shareholder and us, we may not be able to resolve all potential conflicts of interest, and even if we do so, the resolution may be less favorable to us than if we were dealing with a non-controlling shareholder.

***There has been no public market for our ordinary shares or ADSs prior to this offering, and you may not be able to resell our ADSs at or above the price you paid, or at all.***

Prior to this initial public offering, there has been no public market for our ordinary shares or ADSs. We have applied to list the ADSs on Nasdaq Capital Market. Our ordinary shares will not be listed on any exchange or quoted for trading on any over-the-counter trading system.

Negotiations with the underwriters will determine the initial public offering price for our ADSs which may bear no relationship to their market price after the initial public offering. We cannot assure you that an active trading market for our ADSs will develop or that the market price of our ADSs will not decline below the initial public offering price. Investors in the ADSs may experience a significant decrease in the value of the ADSs regardless of our operating performance of prospects. If an active trading market for our ADSs does not develop after this offering, the market price and liquidity of our ADSs will be materially and adversely affected.

***The market price of our ADSs may be volatile, which could result in substantial losses to you.***

The market price of our ADSs can be volatile and fluctuate widely in response to a variety of factors, many of which are beyond our control. The stock market in general and the market for smaller pharmaceutical and biotechnology companies in particular have experienced extreme volatility that has often been unrelated to the operating performance of particular companies. As a result of this volatility, you may not be able to sell your ADSs at or above the initial public offering price and you may lose some or all of your investment.

In addition to market and industry factors, the price and trading volume for our ADSs may be highly volatile due to specific business reasons, including, but not limited to:

- announcements of regulatory approval or a complete response letter, or specific label indications or patient populations for a drug's use, or changes or delays in the regulatory review process;
- announcements of therapeutic innovations, new products, acquisitions, strategic relationships, joint ventures or capital commitments by us or our competitors;
- regulatory developments affecting us, our patients, our customers, our suppliers or our competitors, including adverse actions taken by regulatory agencies with respect to our clinical trials, manufacturing supply chain or sales and marketing activities;
- any adverse changes to our relationship with manufacturers or suppliers;
- the results of our testing and clinical trials;
- the results of our efforts to research and develop additional product candidates or otherwise acquire or license additional product candidates;
- entering into out-licensing or collaborations and any subsequent changes in the terms or structure of these licenses or collaborations;
- appointments of key vendors, including CMOs;
- variations in the level of expenses related to our existing drugs and product candidates or preclinical, clinical development and commercialization programs;
- any litigation or administrative proceedings in which we may become involved, including any intellectual property infringement actions;
- announcements concerning our competitors or the pharmaceutical industry in general;
- actual or anticipated fluctuations in our revenue, operating expenses and profitability, and any other variations in our results of operations;
- manufacture, supply or distribution shortages;
- announcements about our results of operations that are not in line with analyst expectations;
- publication of operating or industry metrics by third parties, including government statistical agencies, that differ from expectations of industry or financial analysts;
- changes in financial estimates by securities research analysts;
- media reports, whether or not true, about our business, our competitors or our industry;
- additions to or departures of our management;
- foreign exchange fluctuations;
- release or expiration of lock-up or other transfer restrictions on our outstanding ordinary shares or ADSs;
- sales or perceived potential sales of additional ordinary shares or ADSs by us, our executive officers and directors or our shareholders;
- general economic and market conditions and overall fluctuations in the U.S. equity markets;
- changes in accounting principles; and
- changes or developments in the United States, Australia, Taiwan, PRC or global regulatory environment.

We expect that, until we are able to commercialize our drug pipeline, the primary drivers of the market price of our ADSs will likely be the results of our research and development efforts, the outcome of our various testing, studies and our overall clinical performance. Nevertheless, the stock market, in general, and pharmaceutical and biotechnology companies have from time to time experienced extreme price and

trading volume fluctuations that have often been unrelated or disproportionate to the clinical and/or operating performance of these companies. Broad market and industry factors may negatively affect the market price of our ADSs, regardless of our actual operating performance. Further, the current volatility in the financial markets and related factors beyond our control may cause the market price of our ADSs to decline rapidly and unexpectedly.

***After the completion of this offering, we may face an increased risk of securities class action litigation, which is expensive and could divert management's attention.***

Historically, securities class action litigation has often been brought against a company following a decline in the market price of its securities. This risk is especially relevant to us because biotechnology and biopharmaceutical companies have experienced significant share price volatilities in recent years. If we were to face such lawsuits, it will likely result in substantial costs and a diversion of management's attention and resources, which could harm our business.

***If securities or industry analysts do not publish research or reports about our business, or if they adversely change their recommendations regarding the ADSs, the market price for the ADSs and trading volume could decline.***

The trading market for the ADSs will be influenced by research or reports that industry or securities analysts publish about our business. If one or more analysts who cover us downgrade the ADSs, the market price for the ADSs would likely decline. If one or more of these analysts cease to cover us or fail to regularly publish reports on us, we could lose visibility in the financial markets, which, in turn, could cause the market price or trading volume for the ADSs to decline.

***Techniques employed by short sellers may drive down the market price of our ADSs.***

Short selling is the practice of selling securities that the seller does not own but rather has borrowed from a third party with the intention of buying identical securities back at a later date to return to the lender. The short seller hopes to profit from a decline in the value of the securities between the sale of the borrowed securities and the purchase of the replacement shares, as the short seller expects to pay less in that purchase than it received in the sale. As it is in the short seller's best interests for the price of the stock to decline, many short sellers publish, or arrange for the publication of, negative opinions regarding the relevant issuer and its business prospects in order to create negative market momentum and generate profits for themselves after selling a stock short. These short attacks have, in the past, led to selling of shares in the market.

Much of the scrutiny and negative publicity has centered on allegations of a lack of effective internal control over financial reporting resulting in financial and accounting irregularities and mistakes, inadequate corporate governance policies or a lack of adherence thereto and, in many cases, allegations of fraud. As a result, many of these companies are now conducting internal and external investigations into the allegations and, in the interim, are subject to shareholder lawsuits and/or SEC enforcement actions.

It is not clear what effect such negative publicity, if it would occur, could have on us. If we were to become the subject of any unfavorable allegations, whether such allegations are proven to be true or untrue, we could have to expend a significant amount of resources to investigate such allegations and/or defend ourselves. While we would strongly defend against any such short seller attacks, we may be constrained in the manner in which it can proceed against the relevant short seller by principles of freedom of speech, applicable state law or issues of commercial confidentiality. Such a situation could be costly and time-consuming, and could distract our management from growing our business. Even if such allegations are ultimately proven to be groundless, allegations against us could severely impact its business operations and stockholders equity, and any investment in our ADSs could be greatly reduced or rendered worthless.

***The sale or availability for sale, or perceived sale or availability for sale, of substantial amounts of our ADSs could adversely affect their market price.***

Sales of substantial amounts of our ADSs in the public market after the completion of this offering, or the perception that these sales could occur, could adversely affect the market price of our ADSs and could

materially impair our ability to raise capital through equity offerings in the future. The ADSs sold in this offering will be freely tradable without restriction or further registration under the Securities Act of 1933, as amended, or the Securities Act, and ordinary shares held by our existing shareholders may also be sold in the public market in the future subject to the restrictions in Rule 144 and Rule 701 under the Securities Act and the applicable lock-up agreements. There will be ADSs (equivalent to ordinary shares) outstanding immediately after this offering. We, our officers, directors, and shareholders holding greater than 5% of our ordinary shares have agreed not to sell any of our ordinary shares or our ADSs or are otherwise subject to similar lockup restrictions for 180 days after the date of this prospectus without the prior written consent of the representative of the underwriters, subject to certain exceptions. However, the representative of the underwriters may release these securities from these restrictions at any time. We cannot predict what effect, if any, market sales of securities held by our significant shareholders or any other shareholder or the availability of these securities for future sale will have on the market price of our ADSs. See “Underwriting” and “Shares Eligible for Future Sale” for a more detailed description of the restrictions on selling our securities after this offering.

***The ADSs are equity and are subordinate to our existing and future indebtedness and any preferred stock we may issue in the future.***

The ADSs are our equity interests and do not constitute indebtedness. As such, ADSs will rank junior to all indebtedness and other non-equity claims on us with respect to assets available to satisfy claims on us, including in a liquidation of us. Additionally, holders of our ADSs may be subject to prior dividend and liquidation rights of any holders of our preferred stock or depositary shares representing such preferred stock then outstanding.

Our board of directors is authorized to issue additional classes or series of preferred stock without any action on the part of the shareholders. The board of directors also has the power, without shareholder approval, to set the terms of any such classes or series of preferred stock that may be issued, including voting rights, dividend rights, and preferences over our ADSs with respect to dividends or upon our dissolution, winding-up and liquidation and other terms. If we issue preferred stock in the future that has a preference over our ADSs with respect to the payment of dividends or upon our liquidation, dissolution, or winding up, or if we issue preferred stock with voting rights that dilute the voting power of our ADSs, the rights of holders of our ADSs or the market price of our ADSs could be adversely affected.

***Holders of ADSs have fewer rights than shareholders and the voting rights of holders of ADSs are limited by the terms of the deposit agreement.***

Holders of ADSs do not have the same rights as our shareholders and may only exercise the voting rights with respect to the underlying ordinary shares in accordance with the provisions of the deposit agreement. As a holder of our ADSs, you will not have any direct right to attend general meetings of our shareholders or to cast any votes at such meetings. As an ADS holder, you will only be able to exercise the voting rights carried by the underlying ordinary shares indirectly by giving voting instructions to the depositary in accordance with the provisions of the deposit agreement. Under the deposit agreement, you may vote only by giving voting instructions to the depositary in the manner set forth in the deposit agreement. Upon receipt of your voting instructions, the depositary will try, as far as is practicable, to vote the ordinary shares underlying your ADSs in accordance with your instructions. If we ask for your instructions, then upon receipt of your voting instructions, the depositary will try to vote the underlying ordinary shares in accordance with these instructions. If we do not instruct the depositary to ask for your instructions, the depositary may still vote in accordance with instructions you give, but it is not required to do so. You will not be able to directly exercise your right to vote with respect to the underlying ordinary shares unless you withdraw the shares, and become the registered holder of such shares prior to the record date for the general meeting. Under our third amended and restated memorandum and articles of association, which will become effective immediately prior to completion of this offering, the minimum notice period required for convening a general meeting is seven (7) calendar days; provided that a general meeting may be called on short notice under specified circumstances. When a general meeting is convened, you may not receive sufficient advance notice of the meeting to withdraw the ordinary shares underlying your ADSs and become the registered holder of such shares to allow you to attend the general meeting and to vote directly with respect to any specific matter or resolution to be considered and voted upon at the general meeting. In addition, under our

third amended and restated memorandum and articles of association, for the purposes of determining those shareholders who are entitled to attend and vote at any general meeting, our directors may fix the date notice is given of a general meeting as the record date, and the setting of such a record date may prevent you from withdrawing the ordinary shares underlying your ADSs and becoming the registered holder of such shares prior to the record date, so that you would not be able to attend the general meeting or to vote directly. If we ask for your instructions, the depositary will notify you of the upcoming vote and will arrange to deliver our voting materials to you. We have agreed to give the depositary notice of shareholder meetings sufficiently in advance of such meetings. Nevertheless, we cannot assure you that you will receive the voting materials in time to ensure that you can instruct the depositary to vote the underlying shares represented by your ADSs. In addition, the depositary and its agents are not responsible for failing to carry out voting instructions or for their manner of carrying out your voting instructions. This means that you may not be able to exercise your right to direct how the ordinary shares underlying your ADSs are voted and you may have no legal remedy if the ordinary shares underlying your ADSs are not voted as you requested. In addition, in your capacity as an ADS holder, you will not be able to call a shareholders' meeting. Except in limited circumstances, the depositary for our ADSs will give us a discretionary proxy to vote the ordinary shares underlying your ADSs if you do not give voting instructions to the depositary, which could adversely affect your interests.

Under the deposit agreement for the ADSs, if you do not give voting instructions to the depositary, the depositary will give us a discretionary proxy to vote the ordinary shares underlying your ADSs at shareholders' meetings unless:

- we have instructed the depositary that we do not wish a discretionary proxy to be given;
- we have informed the depositary that there is substantial opposition as to a matter to be voted on at the meeting;
- a matter to be voted on at the meeting would have an adverse impact on shareholders; or
- the voting at the meeting is to be made on a show of hands.

The effect of this discretionary proxy is that you cannot prevent our ordinary shares underlying your ADSs from being voted, except under the circumstances described above. This may make it more difficult for shareholders to influence the management of our company. Holders of our ordinary shares are not subject to this discretionary proxy.

Furthermore, in the event of voting by a show of hands, pursuant to the terms of the deposit agreement, the depositary will vote (or cause the custodian to vote) all ordinary shares held on deposit at that time in accordance with the voting instructions received from a majority of holders of ADSs who provide timely voting instructions, which may result in the ordinary shares underlying the ADSs held by certain ADS holders being voted in a manner contrary to such ADS holders' voting instructions. See "Description of American Depositary Shares — Voting rights" for more information.

***The depositary for the ADSs is entitled to charge holders of ADSs fees for various services, including annual service fees.***

The depositary for the ADSs is entitled to charge holders of ADSs fees for various services, including for the issuance of ADSs upon deposit of ordinary shares, cancellation of ADSs, distributions of cash dividends or other cash distributions, distributions of ADSs pursuant to share dividends or other free share distributions, distributions of securities other than ADSs and annual service fees. In the case of ADSs issued by the depositary into The Depository Trust Company, or the DTC, the fees will be charged by the DTC participant to the account of the applicable beneficial owner in accordance with the procedures and practices of the DTC participant as in effect at the time. For further information, see "Description of American Depositary Shares — Fees and Charges."

***We have considerable discretion to determine how to use the net proceeds from this offering and may use them in ways with which you may not agree or that may not ultimately yield a favorable return or increase the price of the ADSs.***

Although we currently intend to use the net proceeds from this offering in the manner described in the section titled "Use of Proceeds" in this prospectus, our management will have considerable discretion in

deciding how to apply the net proceeds from this offering, and we could spend the net proceeds from this offering in ways the holders of the ADSs may not agree with or that do not ultimately yield a favorable return. Because of the number and variability of factors that will determine our use of the net proceeds from this offering, our use of these proceeds, while applied in a manner consistent with the manner described in the section titled “Use of Proceeds” in this prospectus, may differ substantially from our current plans. Additionally, in utilizing the proceeds of this offering, under the PRC laws and regulations, we are only allowed to provide funding to our PRC subsidiary through loans or capital contributions. Subject to satisfaction of the applicable government registration and approval requirements, we may extend inter-company loans to our PRC subsidiary or make additional capital contributions to our PRC subsidiary to fund its research and development, capital expenditures or working capital. We cannot assure you that we will be able to obtain these government registrations or approvals in a timely manner, if at all. Further, if we choose to allocate funds to our PRC subsidiary, or if we desire to re-allocate those funds, our PRC subsidiary will have to comply with various PRC laws and regulations.

The failure by our management to apply these funds effectively could have a material adverse effect on our business, financial condition and results of operation. You will not have the opportunity to assess whether the net proceeds from this offering are being used appropriately before making your investment decision. You must rely on the judgment of our management regarding the application of the net proceeds of this offering. We cannot assure you that the net proceeds will be used in a manner that will ultimately yield a favorable return or increase our ADS price, nor that these net proceeds will be placed only in investments that generate income or appreciate in value.

***Your right to participate in any future rights offerings may be limited, which may cause dilution to your holdings.***

We may from time to time distribute rights to our shareholders, including rights to acquire our securities. However, we cannot make rights available to you in the United States unless we register both the rights and the securities to which the rights relate under the Securities Act or an exemption from the registration requirements is available. Under the deposit agreement, the depository will not make rights available to you unless both the rights and the underlying securities to be distributed to ADS holders are either registered under the Securities Act or exempt from registration under the Securities Act. We are under no obligation to file a registration statement with respect to any such rights or securities or to endeavor to cause such a registration statement to be declared effective and we may not be able to establish a necessary exemption from registration under the Securities Act. If the depository does not distribute the rights, if any, it may, under the deposit agreement, either sell them, if possible, or allow them to lapse. Accordingly, you may be unable to participate in our rights offerings and may experience dilution in your holdings.

***You may not receive cash dividends if the depository decides it is impractical to make them available to you.***

The depository will pay cash dividends on the ADSs only to the extent that we decide to distribute dividends on our ordinary shares, and we do not have any present plan to pay any dividends on our ordinary shares. To the extent that there is a distribution, the depository of our ADSs has agreed to pay to you the cash dividends or any other distributions it or the custodian receives on our ordinary shares or other deposited securities after deducting its fees and expenses pursuant to the deposit agreement. You will receive these distributions in proportion to the number of ordinary shares your ADSs represent. However, the depository is not responsible if it decides that it is unlawful to make a distribution available to any holders of ADSs. For instance, it would be unlawful to make a distribution to a holder of ADSs if it consists of securities whose offering would require registration under the Securities Act but are not so properly registered or distributed under an applicable exemption from registration. The depository may also, at its discretion, decide that it is inequitable or impractical to make a distribution available to any holders of ADSs. For example, the depository may determine that it is not practicable to distribute certain property through the mail, or that the value of certain distributions may be less than the cost of mailing them. In these cases, the depository may decide not to distribute such property to you. We have no obligation to register under the U.S. securities laws any offering of ADSs, ordinary shares, rights or other securities that may be received through such distributions. We also have no obligation to take any other action to permit the distribution of ADSs, ordinary shares, rights or anything else to holders of ADSs. This means that you may not receive distributions

we make on our ordinary shares or any value for them if such distributions to you are illegal or impractical. These restrictions may cause a material decline in the value of our ADSs.

***You may be subject to limitations on transfer of your ADSs.***

Your ADSs are transferable on the books of the depository. However, the depository may close its books at any time or from time to time when it deems it expedient in connection with the performance of its duties. The depository may close its books from time to time for a number of reasons, including in connection with corporate events such as a rights offering, during which time the depository needs to maintain an exact number of ADS holders on its books for a specified period. The depository may also close its books in emergencies, and on weekends and public holidays. The depository may refuse to deliver, transfer or register transfers of the ADSs generally when our share register or the books of the depository are closed, or at any time if we or the depository thinks it is advisable to do so because of any requirement of law or of any government or governmental body, or under any provision of the deposit agreement, or for any other reason.

***Certain judgments obtained against us by our shareholders may not be enforceable.***

We are an exempted company with limited liability incorporated in the Cayman Islands. Most of our directors and executive officers, and some of the experts named in this prospectus, are nationals and/or residents of countries other than the United States, and a significant portion of the assets of these persons may be located outside of the United States. As a result, it may be difficult or impossible for you to bring an action against us or against these individuals in the United States in the event that you believe that your rights have been infringed under the U.S. federal securities laws or otherwise. As of the date of this prospectus, none of our officers, directors or other members of our senior management are located in China. Even if you are successful in bringing an action of this kind, the laws of the Cayman Islands may render you unable to enforce a judgment against our assets or the assets of our directors and officers. For more information regarding the relevant laws of the Cayman Islands, see “Enforceability of Civil Liabilities.”

***You may face difficulties in protecting your interests, and your ability to protect your rights through U.S. courts may be limited, because we are incorporated under Cayman Islands law.***

We are an exempted company incorporated under the laws of the Cayman Islands. Our corporate affairs are governed by, among other things, our memorandum and articles of association, the Companies Act (As Revised) of the Cayman Islands and the common law of the Cayman Islands. The rights of shareholders to take action against our directors, actions by our minority shareholders and the fiduciary duties of our directors to us under the Cayman Islands law are to a large extent governed by the common law of the Cayman Islands. The common law of the Cayman Islands is derived in part from comparatively limited judicial precedent in the Cayman Islands as well as from the common law of England, the decisions of whose courts are of persuasive authority, but are not binding, on a court in the Cayman Islands. The rights of our shareholders and the fiduciary duties of our directors under Cayman Islands law are not as clearly established as they would be under statutes or judicial precedent in some jurisdictions in the United States. In particular, the Cayman Islands has a less developed body of securities laws than the United States. Some U.S. states, such as Delaware, have more fully developed and judicially interpreted bodies of corporate law than the Cayman Islands. In addition, the Cayman Islands companies may not have standing to initiate a shareholder derivative action in a federal court of the United States.

Shareholders of Cayman Islands companies like us have no general rights under the Cayman Islands law to inspect corporate records, or to obtain copies of the register of members of these companies, other than the memorandum and articles of association and any special resolutions passed by these companies, and the registers of mortgages and charges of these companies. The Registrar of Companies of the Cayman Islands shall make available the list of the names of the current directors of the Company (and where applicable the current alternate directors of the Company) for inspection by any person upon payment of a fee by such person. Our directors have discretion under our post-offering memorandum and articles of association to determine whether or not, and under what conditions, our corporate records may be inspected by our shareholders, but are not obliged to make them available to our shareholders. This may make it



more difficult for you to obtain the information needed to establish any facts necessary for a shareholder motion or to solicit proxies from other shareholders in connection with a proxy contest.

Certain corporate governance practices in the Cayman Islands, which is our home country, differ significantly from requirements for companies incorporated in other jurisdictions such as the United States. We may in the future rely on home country practice with respect to our corporate governance after we complete this offering. If we choose to follow home country practice in the future, our shareholders may be afforded less protection than they otherwise would under rules and regulations applicable to U.S. domestic issuers.

As a result of all of the above, public shareholders may have more difficulty in protecting their interests in the face of actions taken by our management, members of our board of directors or our controlling shareholders than they would as public shareholders of a company incorporated in the United States. For a discussion of significant differences between the provisions of the Companies Act (As Revised) of the Cayman Islands and the laws applicable to companies incorporated in the United States and their shareholders, see “Description of Share Capital — Differences in Corporate Law.”

***Your rights to pursue claims against the depositary as a holder of ADSs are limited by the terms of the deposit agreement.***

Under the deposit agreement, any action or proceeding against or involving the depositary, arising out of or based upon the deposit agreement or the transactions contemplated thereby or by virtue of owning the ADSs may only be instituted in a state or federal court in New York, New York, and you, as a holder of our ADSs, will have irrevocably waived any objection which you may have to the laying of venue of any such proceeding, and irrevocably submitted to the exclusive jurisdiction of such courts in any such action or proceeding.

The depositary may, in its sole discretion, require that any dispute or difference arising from the relationship created by the deposit agreement be referred to and finally settled by an arbitration conducted under the terms described in the deposit agreement, although the arbitration provisions do not preclude you from pursuing claims under the Securities Act or the Exchange Act in state or federal courts. See “Description of American Depositary Shares” for more information.

***ADSs holders may not be entitled to a jury trial with respect to claims arising under the deposit agreement, which could result in less favorable outcomes to the plaintiff(s) in any such action.***

The deposit agreement governing the ADSs representing our ordinary shares provides that, subject to the depositary’s right to require a claim to be submitted to arbitration, the federal or state courts in the City of New York have exclusive jurisdiction to hear and determine claims arising under the deposit agreement and in that regard, to the fullest extent permitted by law, ADS holders waive the right to a jury trial of any claim they may have against us or the depositary arising out of or relating to our ordinary shares, the ADSs or the deposit agreement, including any claim under the U.S. federal securities laws.

If we or the depositary opposed a jury trial demand based on the waiver, the court would determine whether the waiver was enforceable based on the facts and circumstances of that case in accordance with the applicable state and federal law. To our knowledge, the enforceability of a contractual pre-dispute jury trial waiver in connection with claims arising under the federal securities laws has not been finally adjudicated by the United States Supreme Court. However, we believe that a contractual pre-dispute jury trial waiver provision is generally enforceable, including under the laws of the State of New York, which govern the deposit agreement. In determining whether to enforce a contractual pre-dispute jury trial waiver provision, courts will generally consider whether a party knowingly, intelligently and voluntarily waived the right to a jury trial. We believe that this is the case with respect to the deposit agreement and the ADSs. It is advisable that you consult legal counsel regarding the jury waiver provision before investing in the ADSs.

If you or any other holders or beneficial owners of ADSs bring a claim against us or the depositary in connection with matters arising under the deposit agreement or the ADSs, including claims under federal securities laws, you or such other holder or beneficial owner may not be entitled to a jury trial with respect to such claims, which may have the effect of limiting and discouraging lawsuits against us and / or the

depository. If a lawsuit is brought against us and/or the depository under the deposit agreement, it may be heard only by a judge or justice of the applicable trial court, which would be conducted according to different civil procedures and may result in different outcomes than a trial by jury would have had, including results that could be less favorable to the plaintiff(s) in any such action.

Nevertheless, if this jury trial waiver provision is not enforced, to the extent a court action proceeds, it would proceed under the terms of the deposit agreement with a jury trial. No condition, stipulation or provision of the deposit agreement or ADSs shall relieve us or the depository from our respective obligations to comply with the Securities Act and the Exchange Act.

***Our post-offering memorandum and articles of association contain anti-takeover provisions that could have a material adverse effect on the rights of holders of our ordinary shares and ADSs.***

Our post-offering memorandum and articles of association contain certain provisions that could limit the ability of others to acquire control of our company, including a provision that grants authority to our board of directors to establish from time to time one or more series of preferred shares without action by our shareholders and to determine, with respect to any series of preferred shares, the terms and rights of that series. These provisions could have the effect of depriving our shareholders of the opportunity to sell their shares at a premium over the prevailing market price by discouraging third parties from seeking to obtain control of our company in a tender offer or similar transactions.

***We are a foreign private issuer within the meaning of the rules under the Exchange Act, and as such we are exempt from certain provisions applicable to U.S. domestic public companies.***

Because we qualify as a foreign private issuer under the Exchange Act, we are exempt from certain provisions of the securities rules and regulations in the United States that are applicable to U.S. domestic issuers, including:

- the rules under the Exchange Act requiring the filing with the SEC of quarterly reports on Form 10-Q or current reports on Form 8-K;
- the sections of the Exchange Act regulating the solicitation of proxies, consents, or authorizations in respect of a security registered under the Exchange Act;
- the sections of the Exchange Act requiring insiders to file public reports of their stock ownership and trading activities and liability for insiders who profit from trades made in a short period of time; and
- the selective disclosure rules by issuers of material nonpublic information under Regulation FD.

We will be required to file an annual report on Form 20-F within four months of the end of each fiscal year. In addition, we intend to publish our results on a quarterly basis as press releases, distributed pursuant to the rules and regulations of the Nasdaq Stock Market. Press releases relating to financial results and material events will also be furnished to the SEC on Form 6-K. However, the information we are required to file with or furnish to the SEC will be less extensive and less timely compared to that required to be filed with the SEC by U.S. domestic issuers. As a result, you may not be afforded the same protections or information that would be made available to you were you investing in a U.S. domestic issuer.

***We may lose our foreign private issuer status in the future, which could result in significant additional costs and expenses.***

As discussed above, we are a foreign private issuer, and therefore, we are not required to comply with all of the periodic disclosure and current reporting requirements of the Exchange Act. The determination of foreign private issuer status is made annually on the last business day of an issuer's most recently completed second fiscal quarter, and, accordingly, the next determination will be made with respect to us on June 30, 2022. We would lose our foreign private issuer status if, for example, as of the applicable determination date, more than 50% of our ordinary shares are directly or indirectly held by residents of the United States and we fail to meet additional requirements necessary to maintain our foreign private issuer status. If we lose our foreign private issuer status on June 30, 2022, we will be required to file with the SEC periodic reports and registration statements on U.S. domestic issuer forms beginning on January 1, 2023, which are more detailed

and extensive than the forms available to a foreign private issuer. We will also have to mandatorily comply with U.S. federal proxy requirements, and our officers, directors and principal shareholders will become subject to the short-swing profit disclosure and recovery provisions of the Exchange Act. In addition, we will lose our ability to rely upon exemptions from certain corporate governance requirements under the Nasdaq Stock Market listing rules. As a U.S. listed public company that is not a foreign private issuer, we would incur significant additional legal, accounting and other expenses that we would not otherwise incur as a foreign private issuer.

***As an exempted company incorporated in the Cayman Islands, we are permitted to adopt certain home country practices in relation to corporate governance matters that differ significantly from the Nasdaq corporate governance listing standards. These practices may afford less protection to shareholders than they would enjoy if we complied fully with the Nasdaq corporate governance listing standards.***

As a Cayman Islands exempted company listed on the Nasdaq, we are subject to the Nasdaq corporate governance listing standards. However, the Nasdaq permits a foreign private issuer like us to follow the corporate governance practices of its home country. Certain corporate governance practices in the Cayman Islands, which is our home country, may differ significantly from the Nasdaq corporate governance listing standards. For instance, we are not required to:

- have a majority of the board be independent (although all of the members of the audit committee must be independent under the U.S. Securities Exchange Act of 1934, as amended, or the Exchange Act);
- have a compensation committee or a nominations or corporate governance committee consisting entirely of independent directors; or
- have regularly scheduled executive sessions with only independent directors each year.

We may rely on home country practice with respect to our corporate governance after we complete this offering. If we choose to follow home country practice in the future, our shareholders may be afforded less protection than they otherwise would enjoy under the Nasdaq corporate governance listing standards applicable to U.S. domestic issuers.

***As a “controlled company”, we are exempt from certain Nasdaq corporate governance requirements, which may result in our independent directors not having as much influence as they would if we were not a controlled company.***

We are a “controlled company” as defined under the Nasdaq Stock Market Rules, because one of our shareholders holds more than 50% of our voting power. As a result, for so long as we remain a controlled company as defined under that rule, we are exempt from, and our shareholders generally are not provided with the benefits of, some of the Nasdaq Stock Market corporate governance requirements, including that:

- a majority of our board of directors must be independent directors;
- our compensation committee must be composed entirely of independent directors; and
- our corporate governance and nomination committee must be composed entirely of independent directors.

Although we intend to reconstitute our board of directors and to have a majority of independent directors, that may change in the future.

***Because we do not expect to pay dividends in the foreseeable future, you must rely on price appreciation of our ADSs for return on your investment.***

We currently intend to retain most, if not all, of our available funds and any future earnings to fund the development and growth of our business. As a result, we do not expect to pay any cash dividends in the foreseeable future. Therefore, you should not rely on an investment in the ADSs as a source for any future dividend income.

Our Board of Directors has complete discretion as to whether to distribute dividends, subject to certain requirements of Cayman Islands law. In addition, our shareholders may by ordinary resolution declare a dividend, but no dividend may exceed the amount recommended by our directors. Under Cayman Islands law, a Cayman Islands company may pay a dividend out of either profit or share premium account, provided that in no circumstances may a dividend be paid if this would result in the company being unable to pay its debts as they fall due in the ordinary course of business. Even if our Board of Directors decides to declare and pay dividends, the timing, amount and form of future dividends, if any, will depend on our future results of operations and cash flow, our capital requirements and surplus, the amount of distributions, if any, received by us from our subsidiaries, our financial condition, contractual restrictions and other factors deemed relevant by our Board of Directors. Accordingly, the return on your investment in the ADSs will likely depend entirely upon any future price appreciation of the ADSs. There is no guarantee that the ADSs will appreciate in value after this offering or even maintain the price at which you purchased the ADSs. You may not realize a return on your investment in the ADSs and you may even lose your entire investment in the ADSs.

***We may be classified as a passive foreign investment company, which could result in adverse U.S. federal income tax consequences to U.S. investors of our ADSs or ordinary shares.***

Based on current estimates of our gross income and the value of our gross assets (including goodwill) and the manner in which we conduct our business, we do not expect to be a passive foreign investment company (“PFIC”) for U.S. federal income tax purposes for the taxable year 2022. Despite our expectation, there can be no assurance that we will not be a PFIC in the current taxable year or any future taxable year as PFIC status is tested each taxable year and will depend on the composition of our assets and income and the value of our assets in each such taxable year.

A non-U.S. corporation is a passive foreign investment company (“PFIC”) for U.S. federal income tax purposes for any taxable year in which (after taking into account the income and assets of subsidiaries in which it owns at least a 25% interest by value), (i) at least 75% of its gross income is “passive” income, such as interest and income from financial investments (the “income test”) or (ii) at least 50% of the average value of its assets (generally determined on a quarterly basis) consists of assets that produce or are held to produce passive income (the “asset test”). For purposes of the asset test, any cash and cash equivalents (such as bank deposits) will count as passive assets, and goodwill should be treated as an active asset to the extent associated with activities that produce or intended to produce active income. In determining the average percentage value of our gross assets, the aggregate value of our assets will generally be deemed to be equal to our market capitalization (determined by the sum of the aggregate value of our outstanding equity) plus our liabilities. We could be a PFIC for any future taxable year if our market capitalization were to decrease significantly while we hold substantial cash and cash equivalents, or if the gross income that we and our subsidiaries earn from investing the portion of cash raised in this offering is substantial in comparison with the gross income from our business operation.

If we were treated as a PFIC for any taxable year, then U.S. investors could be subject to adverse U.S. federal income tax consequences (regardless of whether we continue to be a PFIC), including increased tax liability on disposition gains and certain “excess distributions” and additional reporting requirements. See “United States Federal Income Tax Considerations — Passive Foreign Investment Company” for further information. U.S. investors should consult their tax advisers regarding our PFIC status for any taxable year and the potential application of the PFIC rules to an investment in our ADSs or ordinary shares including the availability and the advisability of making certain elections under the PFIC rules.

***We are an emerging growth company within the meaning of the Securities Act and may take advantage of certain reduced reporting requirements.***

We are an “emerging growth company,” as defined in the JOBS Act, and we may take advantage of certain exemptions from requirements applicable to other public companies that are not emerging growth companies, including, most significantly, not being required to comply with the auditor attestation requirements of Section 404 of the Sarbanes-Oxley Act of 2002 for so long as we remain an emerging growth company. As a result, if we elect not to comply with such auditor attestation requirements, our investors may not have access to certain information they may deem important.

The JOBS Act also provides that an emerging growth company does not need to comply with any new or revised financial accounting standards until such date that a private company is otherwise required to comply with such new or revised accounting standards. Pursuant to the JOBS Act, we have elected to take advantage of the benefits of this extended transition period for complying with new or revised accounting standards. As a result, our operating results and financial statements may not be comparable to the operating results and financial statements of other companies who have adopted the new or revised accounting standards.

We will remain an emerging growth company until the earliest of (a) the last day of the fiscal year during which we have total annual gross revenues of at least US\$1.07 billion; (b) the last day of our fiscal year following the fifth anniversary of the completion of this offering; (c) the date on which we have, during the preceding three-year period, issued more than US\$1.0 billion in non-convertible debt; or (d) the date on which we are deemed to be a “large accelerated filer” under the Securities Exchange Act of 1934, as amended, or the Exchange Act, which would occur if the market value of the ADSs that are held by non-affiliates exceeds US\$700 million as of the last business day of our most recently completed second fiscal quarter. Once we cease to be an emerging growth company, we will not be entitled to the exemptions provided in the JOBS Act discussed above.

We cannot predict if investors will find our ADSs less attractive because we may rely on these exemptions. If some investors find our ADSs less attractive as a result, there may be a less active trading market for our ADSs and the price of our ADSs may be more volatile.

***We expect to incur increased costs as a result of being a public company, and will incur further increased costs after we cease to qualify as an “emerging growth company.”***

We will become a public company after this offering, and expect to incur significant legal, accounting and other expenses that we would not incur as a private company. The Sarbanes-Oxley Act of 2002, as well as rules subsequently implemented by the SEC and the Nasdaq Stock Market, impose various requirements on the corporate governance practices of public companies. As a company with less than US\$1.07 billion in revenues for our last fiscal year, we qualify as an “emerging growth company” pursuant to the JOBS Act. An emerging growth company may take advantage of specified reduced reporting and other requirements that are otherwise applicable generally to public companies. These provisions include exemption from the auditor attestation requirement under Section 404 of the Sarbanes-Oxley Act of 2002 in the assessment of the emerging growth company’s internal control over financial reporting and permission to delay adopting new or revised accounting standards until such time as those standards apply to private companies.

We expect these rules and regulations to increase our legal and financial compliance costs and to make some corporate activities more time-consuming and costly. After we are no longer an “emerging growth company,” we expect to incur significant expenses and devote substantial management effort toward ensuring compliance with the requirements of Section 404 of the Sarbanes-Oxley Act of 2002 and the other rules and regulations of the SEC. For example, as a result of becoming a public company, we need to increase the number of independent directors and adopt policies regarding internal controls and disclosure controls and procedures. We also expect that operating as a public company will make it more difficult and more expensive for us to obtain director and officer liability insurance, and we may be required to accept reduced policy limits and coverage or incur substantially higher costs to obtain the same or similar coverage. In addition, we will incur additional costs associated with our public company reporting requirements. It may also be more difficult for us to find qualified persons to serve on our board of directors or as executive officers. We are currently evaluating and monitoring developments with respect to these rules and regulations, and we cannot predict or estimate with any degree of certainty the amount of additional costs we may incur or the timing of such costs.

In the past, shareholders of a public company often brought securities class action suits against the company following periods of instability in the market price of that company’s securities. If we were involved in a class action suit, it could divert a significant amount of our management’s attention and other resources from our business and operations, which could harm our results of operations and require us to incur significant expenses to defend the suit. Any such class action suit, whether or not successful, could harm our reputation and restrict our ability to raise capital in the future. In addition, if a claim is successfully made against us, we may be required to pay significant damages.

### SPECIAL NOTE REGARDING FORWARD-LOOKING STATEMENTS

This prospectus contains forward-looking statements that reflect our current expectations and views of future events. The forward-looking statements are contained principally in the sections entitled “Prospectus Summary,” “Risk Factors,” “Management’s Discussion and Analysis of Financial Condition and Results of Operations” and “Business.” Known and unknown risks, uncertainties and other factors, including those listed under “Risk Factors,” may cause our actual results, performance or achievements to be materially different from those expressed or implied by the forward-looking statements.

You can identify some of these forward-looking statements by words or phrases such as “may,” “will,” “expect,” “anticipate,” “aim,” “estimate,” “intend,” “plan,” “believe,” “is/are likely to,” “potential,” “continue” or other similar expressions. We have based these forward-looking statements largely on our current expectations and projections about future events that we believe may affect our financial condition, results of operations, business strategy and financial needs. These forward-looking statements include statements relating to:

- the timing of the initiation, progress and potential results of our preclinical studies, clinical trials and our discovery programs;
- the timing and likelihood of regulatory filings and approvals, including with respect to additional indications beyond the initial indication for which we are seeking approval for our product candidates;
- our ability to advance our product candidates into drugs, and the successful completion of clinical trials;
- the approval, commercialization, pricing and reimbursement of our product candidates;
- the competitive landscape and size of the market opportunity for our product candidates, including our estimates of the number of patients who suffer from the diseases we are targeting;
- estimates of our costs, expenses, future revenues, capital expenditures and our needs for additional financing;
- our ability to continue as a going concern;
- our ability to attract and retain senior management and key employees;
- our future business development, financial condition and results of operations;
- future developments, trends, conditions and competitive landscape in the industry and markets in which we operate;
- our strategies, plans, objectives and goals and our ability to successfully implement these strategies, plans, objectives and goals;
- costs associated with enforcing or defending against intellectual property infringement, misappropriation or violation, product liability and other claims;
- our ability to establish and maintain collaborations or licensing agreements;
- our ability to identify and integrate new product candidates, technologies and/or suitable acquisition targets;
- our ability to effectively manage our growth;
- our proposed use of proceeds;
- changes to regulatory and operating conditions in our industry and markets.
- potential impact of the COVID-19 pandemic on our current and future business development, financial condition and results of operations.

You should read this prospectus completely and with the understanding that our actual future results may be materially different from and worse than what we expect. Moreover, we operate in an evolving environment. New risk factors and uncertainties emerge from time to time and it is not possible for our management to predict all the risk factors and uncertainties, nor can we assess the impact of all factors on

our business or the extent to which any factor, or combination of factors, may cause actual results to differ materially from those contained in any forward-looking statements. We qualify all of our forward-looking statements by these cautionary statements.

You should not rely upon forward-looking statements as predictions of future events. The forward-looking statements made in this prospectus relate only to events or information as of the date on which the statements are made in this prospectus. Except as required by law, we undertake no obligation to update or revise any forward-looking statements, whether as a result of new information, future events or otherwise.

## USE OF PROCEEDS

We estimate that we will receive net proceeds from this offering of approximately US\$            million, or approximately US\$            million if the underwriters exercise their option to purchase additional ADSs, after deducting underwriting discounts and commissions and the estimated offering expenses payable by us. These estimates are based upon an assumed initial public offering price of US\$            per ADS, which is the midpoint of the price range shown on the front page of this prospectus. A US\$1.00 increase (decrease) in the assumed initial public offering price of US\$ per ADS would increase (decrease) the net proceeds to us from this offering by US\$           , assuming the number of ADSs offered by us, as set forth on the front cover of this prospectus, remains the same and after deducting the estimated underwriting discounts and commissions and estimated expenses payable by us.

The primary purposes of this offering are to create a public market for our shares for the benefit of all shareholders, retain talented employees by providing them with equity incentives, and obtain additional capital. We plan to use the net proceeds of this offering as follows:

- approximately 6.1% for our Phase 3 clinical trial of LBS-008 for STGD1,
- approximately 60.2% for further clinical development of LBS-008 for dry AMD, such as Phase 2 or Phase 3 clinical trials, and
- the remainder for working capital and other general corporate purposes.

We estimate the net proceeds of this offering would enable us to complete our ongoing Phase 2 and Phase 3 clinical trials of LBS-008 for STGD1, and to obtain interim results of our anticipated Phase 2 or Phase 3 clinical trials of LBS-008 for dry AMD.

The foregoing represents our current intentions based upon our present plans and business conditions to use and allocate the net proceeds of this offering. Our management, however, will have broad discretion in the application of our net proceeds from this offering, and investors will be relying on the judgment of our management regarding the application of these proceeds. See “Risk Factors — Risks Related to This Offering and Our ADSs — We have considerable discretion to determine how to use the net proceeds from this offering and may use them in ways with which you may not agree or that may not ultimately yield a favorable return or increase the price of the ADSs.” Due to the many variables inherent in the development of product candidates, such as the size and timing of patient enrollment, evolving regulatory requirements and the associated costs, we cannot currently predict the stage of development that we will be able to achieve for the product candidates in our pipeline with the net proceeds of this offering. The amounts and timing of our actual expenditures may vary significantly depending on numerous factors, including the results of the preclinical studies and clinical trials of our product candidates, our operating costs and expenditures, any strategic collaborations that we may enter into with third parties and the amount of cash generated by our operations. If an unforeseen event occurs or business conditions change, we may use the proceeds of this offering differently than as described in this prospectus.

In using the proceeds of this offering, we are permitted as an offshore holding company to provide funding under PRC laws and regulations to our PRC subsidiary only through loans or capital contributions. Subject to satisfaction of the applicable government registration and approval requirements, we may extend inter-company loans to our PRC subsidiary or make additional capital contributions to our PRC subsidiary to fund its research and development, capital expenditures or working capital. We cannot assure you that we will be able to obtain these government registrations or approvals on a timely basis, or at all.



**DIVIDEND POLICY**

We have not previously declared or paid cash dividends on our ordinary shares and we have no plan to declare or pay any dividends in the near future on our ordinary shares or ADSs. We currently intend to retain most, if not all, of our available funds and any future earnings to operate and expand our business.

Our Board of Directors has discretion as to whether to distribute dividends, subject to certain requirements of Cayman Islands law. In addition, subject to the provisions in our articles of association, our shareholders may by ordinary resolution declare a dividend, but no dividend may exceed the amount recommended by our Board of Directors. Even if our Board of Directors decides to pay dividends, the form, frequency and amount will depend upon our future operations and earnings, capital requirements and surplus, general financial condition, contractual restrictions and other factors that the board of directors may deem relevant.

We are a holding company incorporated in the Cayman Islands. We have not received and do not have any present plan to receive dividends paid by our U.S., Australia, Hong Kong and PRC subsidiaries, but we have discretion as to whether such dividends are paid, subject to applicable statutory and contractual restrictions, including PRC regulations which may govern the ability of our PRC subsidiary to pay dividends to us.

If we pay any dividends on our ordinary shares, we will pay those dividends which are payable in respect of the underlying ordinary shares represented by the ADSs to the depository, as the registered holder of such ordinary shares, and the depository then will pay such amounts to the ADS holders in proportion to the underlying ordinary shares represented by the ADSs held by such ADS holders, subject to the terms of the deposit agreement, including the fees and expenses payable thereunder. See "Description of American Depositary Shares."

## CAPITALIZATION

The following table sets forth our capitalization as of December 31, 2021:

- on an actual basis;
- on a pro forma basis to reflect the automatic conversion of all of the issued and outstanding preferred shares on a one-for-one basis into ordinary shares immediately prior to the completion of this offering; and
- on a pro forma as adjusted basis to reflect (i) the automatic conversion of all of the issued and outstanding preferred shares on a one-for-one basis into ordinary shares immediately prior to the completion of this offering; and (ii) the issuance and sale of ordinary shares in the form of ADSs by us in this offering at an assumed initial public offering price of US\$ per ADS, the midpoint of the estimated range of the initial public offering price shown on the front cover of this prospectus, after deducting the underwriting discounts and commissions and estimated offering expenses payable by us.

You should read this table together with our consolidated financial statements and the related notes included elsewhere in this prospectus and the information under “Management’s Discussion and Analysis of Financial Condition and Results of Operations.”

	As of December 31, 2021		
	Actual	Pro forma	Pro forma as adjusted <sup>(1)</sup>
	(amounts in US\$ thousands, except for shares and per share data)		
	\$	\$	\$
<b>Convertible preferred shares:</b>			
Series A convertible preferred shares, US\$0.0001 par value; 2,377,642 shares (actual) and no shares (pro forma and pro forma as adjusted) authorized; 2,377,642 shares issued and outstanding (actual); shares issued and outstanding (pro forma and pro forma as adjusted)	\$ 8,806	—	—
Series B convertible preferred shares, US\$0.0001 par value; 5,443,272 shares (actual) and no shares (pro forma and pro forma as adjusted) authorized; 5,443,272 shares issued and outstanding (actual); shares issued and outstanding (pro forma and pro forma as adjusted)	\$ 23,000	—	—
<b>Total convertible preferred shares</b>	<b>\$ 31,806</b>	<b>—</b>	<b>—</b>
<b>Shareholders’ deficit:</b>			
Ordinary shares, par value of US\$0.0001 per share; 492,179,086 shares authorized; 10,274,403 shares issued and outstanding (actual); shares issued and outstanding (pro forma and pro forma as adjusted)	1		
Additional paid-in capital	12,325		
Accumulated other comprehensive loss	(196)		
Accumulated deficit	(27,223)		
<b>Total shareholders’ equity (deficit)</b>	<b>(15,093)</b>		
<b>Total capitalization</b>	<b>\$ 18,348</b>	<b>\$</b>	<b>\$</b>

---

Notes:

- (1) The pro forma as adjusted information discussed above is illustrative only. Our additional paid-in capital, total shareholders' (deficit) equity, and total convertible preferred shares and shareholders' (deficit) equity following the completion of this offering are subject to adjustment based on the actual initial public offering price and other terms of this offering determined at pricing.

A US\$1.00 increase (decrease) in the assumed initial public offering price of US\$                      per ADS, the midpoint of the range set forth on the cover page of this prospectus, would increase (decrease) each of additional paid-in capital, total shareholders' (deficit)/equity, and total mezzanine equity and shareholders' (deficit)/equity by US\$                      million.

## DILUTION

If you invest in the ADSs, your interest will be diluted to the extent of the difference between the initial public offering price per ADS and our net tangible book value per ADS after this offering. Dilution results from the fact that the initial public offering price per ordinary share is substantially in excess of the net tangible book value per ordinary share attributable to the existing shareholders for our presently outstanding ordinary shares.

Our net tangible book value as of December 31, 2021 was approximately US\$16.7 million, representing US\$                      per ordinary share on a pro forma basis and US\$                      per ADS. Net tangible book value represents the amount of our total consolidated tangible assets less total consolidated liabilities. Pro Forma net tangible book value per ordinary share is calculated after giving effect to the automatic conversion of all of our issued and outstanding convertible preferred shares. Dilution is determined by subtracting pro forma net tangible book value per ordinary share, after giving effect to the additional proceeds we will receive from this offering, from the assumed initial public offering price of US\$                      per ordinary share, which is the midpoint of the estimated initial public offering price range set forth on the front cover of this prospectus adjusted to reflect the ADS-to-ordinary share ratio, and after deducting underwriting discounts and commissions and estimated offering expenses payable by us.

Without taking into account any other changes in pro forma net tangible book value after December 31, 2021, after giving effect to our sale of the ADSs offered in this offering at the assumed initial public offering price of US\$                      per ADS, which is the midpoint of the estimated initial public offering price range, after deduction of the underwriting discounts and commissions and estimated offering expenses payable by us, our pro forma as adjusted net tangible book value as of December 31, 2021 would have been US\$                      , or US\$                      per ordinary share and US\$                      per ADS. This represents an immediate increase in net tangible book value of US\$                      per ordinary share and US\$                      per ADS to the existing shareholders and an immediate dilution in net tangible book value of US\$                      per ordinary share and US\$                      per ADS to investors purchasing ADSs in this offering. The following table illustrates such dilution:

	Per Ordinary Share	Per ADS
Assumed initial public offering price	US\$	US\$
Net tangible book value as of December 31, 2021	US\$	US\$
Pro forma net tangible book value after giving effect to the conversion of our preferred shares	US\$	
Pro forma as adjusted net tangible book value after giving effect to the conversion of our preferred shares and this offering	US\$	US\$
Amount of dilution in net tangible book value to new investors in this offering	US\$	US\$

A US\$1.00 increase (decrease) in the assumed initial public offering price of US\$                      per ADS would increase (decrease) our pro forma as adjusted net tangible book value after giving effect to this offering by US\$                      , the pro forma as adjusted net tangible book value per ordinary share and per ADS after giving effect to this offering by US\$                      per ordinary share and US\$                      per ADS, and the dilution in pro forma as adjusted net tangible book value per ordinary share and per ADS to new investors in this offering by US\$                      per ordinary share and US\$                      per ADS, assuming no change to the number of ADSs offered by us as set forth on the front cover of this prospectus, and after deducting underwriting discounts and commissions and estimated offering expenses payable by us.

If the representative of the underwriters exercise in full the option to purchase additional ADSs from us, based on the assumed public offering price of US\$                      per ADS, the pro forma as adjusted net tangible book value after this offering would be US\$                      per ordinary share and US\$                      per ADS, and the dilution to new investors purchasing ADSs in this offering would be US\$                      per ordinary share and US\$                      per ADS.

The following table summarizes, on a pro forma as adjusted basis as of December 31, 2021, the differences between existing shareholders and the new investors with respect to the number of ordinary

shares (represented by ADSs) purchased from us, the total consideration paid and the average price per ordinary share and per ADS paid before deducting the underwriting discounts and commissions and estimated offering expenses payable by us. The total number of ordinary shares does not include ordinary shares underlying the ADSs issuable upon the exercise of the option to purchase additional ADSs granted to the underwriters.

	Ordinary Shares Purchased		Total Consideration		Average Price Per Ordinary Share	Average Price Per ADS
	Number	Percent	Amount	Percent	US\$	US\$
Existing shareholders			% US\$		% US\$	US\$
New investors			% US\$		% US\$	US\$
Total		100.0%	US\$	100.0%		

The pro forma as adjusted information discussed above is illustrative only. Our net tangible book value following the completion of this offering is subject to adjustment based on the actual initial public offering price of the ADSs and other terms of this offering determined at pricing.

The discussion and table above assume no exercise of any share options outstanding as of the date of this prospectus. As of the date of this prospectus, there are 1,982,561 outstanding options with an average exercise price of US\$0.4626 per share. To the extent that any of these options are exercised, there will be further dilution to new investors.

### ENFORCEABILITY OF CIVIL LIABILITIES

We are incorporated under the laws of the Cayman Islands as an exempted company with limited liability. We are incorporated in the Cayman Islands to take advantage of certain benefits associated with being a Cayman Islands exempted company, such as:

- political and economic stability,
- an effective judicial system,
- a favorable tax system,
- the absence of foreign exchange control or currency restrictions, and
- the availability of professional and support services.

However, certain disadvantages accompany incorporation in the Cayman Islands. These disadvantages include but are not limited to:

- the Cayman Islands has a less developed body of securities laws as compared to the United States and these securities laws provide significantly less protection to investors as compared to the United States; and
- Cayman Islands companies may not have standing to sue before the federal courts of the United States.

Our memorandum and articles of association does not contain provisions requiring that disputes, including those arising under the securities laws of the United States, between us, our officers, directors, and shareholders, be arbitrated.

Most of our directors and officers are nationals or residents of jurisdictions other than the United States and most of their assets are located outside the United States. As a result, it may be difficult for a shareholder to effect service of process within the United States upon these individuals, or to bring an action against us or these individuals in the United States, or to enforce against us or them judgments obtained in United States courts, including judgments predicated upon the civil liability provisions of the securities laws of the United States or any state in the United States. As of the date of this prospectus, none of our officers, directors or other members of our senior management are located in China.

We have appointed Puglisi & Associates, located at 850 Library Avenue, Suite 204, Newark, Delaware 19711, as our agent upon whom process may be served in any action brought against us under the securities laws of the United States.

Maples and Calder (Hong Kong) LLP, our counsel as to Cayman Islands law, has advised us that there is uncertainty as to whether the courts of the Cayman Islands would (a) recognize or enforce judgments of U.S. courts obtained against us or our directors or officers that are predicated upon the civil liability provisions of the federal securities laws of the United States or the securities laws of any state in the United States, or (b) entertain original actions brought in the Cayman Islands against us or our directors or officers that are predicated upon the federal securities laws of the United States or the securities laws of any state in the United States.

Maples and Calder (Hong Kong) LLP has informed us that although there is no statutory enforcement in the Cayman Islands of judgments obtained in the federal or state courts of the United States (and the Cayman Islands are not a party to any treaties for the reciprocal enforcement or recognition of such judgments), the courts of the Cayman Islands would recognize and enforce a final and conclusive judgement in personam obtained in federal or state courts in the United States under which a sum of money is payable (other than a sum of money payable in respect of multiple damages, taxes or other charges of a like nature, a fine or a penalty or similar fiscal or revenue obligations) or, in certain circumstances, an in personam judgment for non-monetary relief, and would give a judgment based thereon provided that: (a) such courts had proper jurisdiction over the parties subject to such judgment; (b) such courts did not contravene the rules of the natural justice of Cayman Islands; (c) such judgment was not obtained by fraud; (d) such judgment was not obtained in a manner, and is not of a kind the enforcement of which, is contrary to natural justice or the public policy of the Cayman Islands; (e) no new admissible evidence relevant to the

action is submitted prior to the rendering of the judgment by the courts of the Cayman Islands; and (f) there is due compliance with the correct procedures under the laws of the Cayman Islands. However, the Cayman Islands courts are unlikely to enforce a punitive judgment of a United States court predicated upon the civil liability provisions of the federal securities laws in the United States without retrial on the merits if such judgment is determined by the courts of the Cayman Islands to give rise to obligations to make payments that may be regarded as fines, penalties or punitive in nature. A Cayman Islands court may stay enforcement proceedings if concurrent proceedings are being brought elsewhere.

## CORPORATE HISTORY AND STRUCTURE

**Corporate History**

The Company was incorporated under the laws of the Cayman Islands on March 27, 2018. We are engaged in research and development of novel therapeutics targeting significant unmet needs.

In June 2016, Lin BioScience, Inc., a public company in Taiwan (stock code: 6696.TW), which is our ultimate controlling shareholder (i.e., the sole shareholder of our principal shareholder, Lin Bioscience International Ltd.), established Belite Bio Holdings Corp. (formerly known as Lin BioScience Holdings Corporation) and Belite Bio, LLC (formerly known as Lin BioScience, LLC), in Delaware. Belite Bio Holdings Corp. is an intermediate holding company and owns 100% equity interests in Belite Bio, LLC, which is mainly engaged in research and development of LBS-008 and LBS-009.

In March 2018, as a part of a reorganization, Lin BioScience, Inc. established the Company (formerly known as Lin BioScience Co., Ltd.) in the Cayman Islands, as a subsidiary to its wholly-owned subsidiary Lin Bioscience International Ltd.

In June 2018, as a part of the reorganization, Lin Bioscience International Ltd., acquired the entire equity interest in Belite Bio Holdings Corp. from Lin BioScience, Inc. and then contributed the entire equity interest in Belite Bio Holdings Corp. to us in July 2018. After this contribution, Belite Bio Holdings Corp. became our wholly-owned subsidiary, which in turn owns 100% equity interests in Belite Bio, LLC.

Before and after the reorganization, we were, together with our subsidiaries, effectively controlled by the same shareholders, and therefore the reorganization is considered a recapitalization of entities under common control in accordance with Accounting Standards Codification (“ASC”) 805-50-25. The consolidation of us and our subsidiaries have been accounted for at historical cost in the accompanying consolidated financial statements in accordance with ASC 805-50-45-5.

In August 2018, Belite Bio Holdings Corp. established RBP4 Pty Ltd in Australia as its wholly-owned subsidiary for carrying out clinical trials in Australia and tax refund purposes.

In June 2021, we established Belite Bio (HK) Limited in Hong Kong as a wholly-owned subsidiary which established Belite Bio (Shanghai) Limited in Shanghai, China in August 2021 with an aim to carry out clinical trials of our product candidates in China in the future.

**Our Corporate Structure**

The chart below sets forth our corporate structure and identifies our significant subsidiaries and their significant subsidiaries, as of the date of this prospectus:

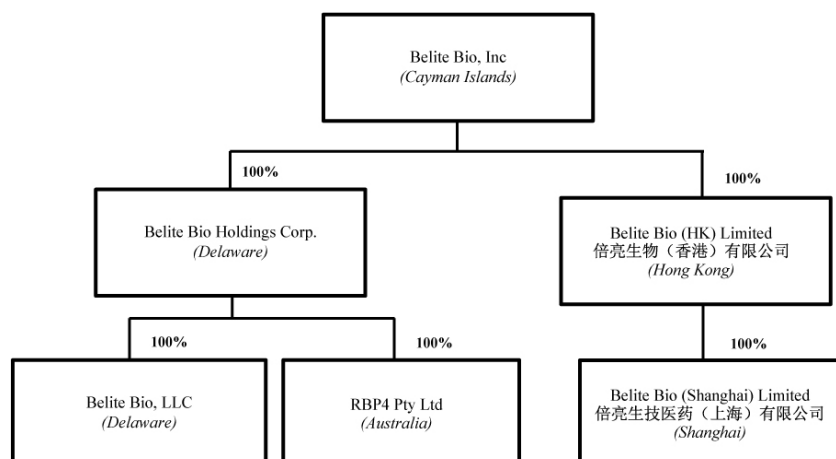



### SELECTED CONSOLIDATED FINANCIAL DATA

The following selected consolidated statement of operations and comprehensive loss data for the years ended December 31, 2020 and 2021 and selected consolidated balance sheet data as of December 31, 2020 and December 31, 2021 have been derived from our audited consolidated financial statements included elsewhere in this prospectus.

Our consolidated financial statements are prepared and presented in accordance with U.S. GAAP. Our historical results do not necessarily indicate results expected for any future periods. You should read this Selected Consolidated Financial Data section together with our consolidated financial statements and the related notes and “Management’s Discussion and Analysis of Financial Condition and Results of Operations” included elsewhere in this prospectus.

	For the Year Ended December 31,	
	2020	2021
	(In thousand US Dollars, except share and per share amounts)	
<b>Selected Consolidated Statements of Operations and Comprehensive Loss</b>		
Total operating expenses <sup>(1)</sup>	5,743	9,797
Total other (expense) income, net	(9)	131
Net loss	(5,753)	(9,666)
Total comprehensive loss	\$ (5,747)	\$ (9,818)
Weighted average number of ordinary shares used in per share calculation, basic and diluted	8,790,397	9,569,932
Net loss per ordinary share, basic and diluted	(0.65)	(1.01)

(1) Total share-based compensation costs were recognized as follows for the years ended December 31, 2020 and 2021:

	Year Ended	
	December 31, 2020	December 31, 2021
	(amounts in \$ and in thousands)	
Research and development	\$ 77	\$ 52
General and administrative	1,286	1,478
Total	\$1,363	\$1,530

	As of	As of
	December 31, 2020	December 31, 2021
	(amounts in \$ and in thousands)	
<b>Selected Consolidated Balance Sheets Data:</b>		
Cash	\$25,618	\$ 17,344
Total assets	\$25,741	\$ 18,348
Total liabilities	\$ 972	\$ 1,635
Total convertible preferred shares	\$31,806	\$ 31,806
Total shareholders’ deficit	\$ (7,037)	\$ (15,093)
Total liabilities, convertible preferred shares and shareholders’ deficit	\$25,741	\$ 18,348

## MANAGEMENT'S DISCUSSION AND ANALYSIS OF FINANCIAL CONDITION AND RESULTS OF OPERATIONS

*You should read the following discussion and analysis of our financial condition and results of operations together with "Selected Consolidated Financial Data," and our financial statements and the related notes appearing elsewhere in this prospectus. Some of the information contained in this discussion and analysis or set forth elsewhere in this prospectus, including information with respect to our plans and strategy for our business, includes forward-looking statements that involve risks and uncertainties. You should read the "Risk factors" and "Cautionary note regarding forward-looking statements" sections of this prospectus for a discussion of important factors that could cause actual results to differ materially from the results described in or implied by the forward-looking statements contained in the following discussion and analysis. The terms "our company", "we", "our" or "us" as used herein refer to Belite Bio, Inc and its subsidiaries unless otherwise stated or indicated by context.*

### Overview

We are a clinical stage biopharmaceutical drug development company focused on novel therapeutics targeting currently untreatable eye diseases involving retinal degeneration such as atrophic age-related macular degeneration (commonly known as dry AMD) and autosomal recessive Stargardt disease, or STGD1, both of which progressively lead to permanent blindness, and metabolic diseases such as non-alcoholic fatty liver disease, or NAFLD, nonalcoholic steatohepatitis, or NASH, type 2 diabetes, or T2D, and gout.

We believe our lead product candidate, LBS-008, or Tinlarebant, if approved, would provide a novel treatment option where there currently is none. LBS-008 is an oral once-a-day treatment that can reduce and maintain the delivery of vitamin A (retinol) to the eye as a means to reduce the accumulation of toxic vitamin A by-products in ocular tissue. This effect is achieved through the ability of LBS-008 to reduce and maintain the level of serum retinol binding protein 4, or RBP4, which carries retinol from the liver to the eye. In clinical trials, LBS-008 has demonstrated its target specificity and potency that we believe could be clinically meaningful to treat STGD1 patients. We initiated an open-label, dose-finding Phase 1b/2 clinical trial in adolescent STGD1 patients in mid-2020 in Australia and Taiwan. The study design includes two portions: Phase 1b and Phase 2. We have completed the Phase 1b portion of this study in 11 adolescent STGD1 patients which has extended into a two-year, Phase 2 study with 13 adolescent STGD1 patients in Australia and Taiwan. The preliminary data from the Phase 1b portion has shown that LBS-008 can achieve a mean RBP4 reduction of > 70%, relative to baseline values. We are currently conducting the Phase 2 portion of this study.

As of the date of this prospectus, we have initiated our Phase 3 clinical trial, to evaluate the safety and efficacy of LBS-008 in adolescent STGD1 patients and received approval to commence patient enrollment in Taiwan, the U.K., Hong Kong and Switzerland. In addition, we are in the process of applying for the necessary approvals to conduct the same clinical trial in other relevant jurisdictions. Previously, we completed a Phase 1 clinical trial of LBS-008 in healthy adult subjects in mid-2020. We are currently evaluating our plans to conduct a Phase 2 or Phase 3 trial in 2022 to evaluate the safety and efficacy of LBS-008 in the treatment of dry AMD.

Since our inception in 2016, our operations have focused on organizing and staffing our Company, business planning, raising capital, acquiring rights to product candidates, developing our product candidates, including conducting preclinical studies and clinical trials, and establishing our intellectual property portfolio. Our ultimate controlling shareholder, Lin BioScience, Inc., obtained from Columbia University an exclusive worldwide license to the RBP4 IP Portfolio, which contains disclosure directed to over 400 structurally distinct compounds including our lead product candidate, LBS-008, in September 2016, which was initially assigned to our principal shareholder, Lin Bioscience International Ltd., and subsequently assigned to us in 2018.

To date, we have not generated any revenues. We have financed our operations primarily through approximately \$40.6 million in proceeds from the issuance of our ordinary shares, the private placement of shares of our convertible preferred stock and the issuance of our convertible promissory notes. We have incurred annual net operating losses in each year since our inception and expect to continue to incur net

operating losses for the foreseeable future. Our net losses were approximately \$5.8 million and \$9.7 million for the years ended December 31, 2020 and 2021, respectively. As of December 31, 2021, we had an accumulated deficit of approximately \$27.2 million. Our independent registered public accounting firm has included in its audit report on our financial statements as of and for the year ended December 31, 2021, an explanatory paragraph regarding a substantial doubt about our ability to continue as a going concern. We expect to continue to incur significant expenses and increasing operating losses for the next several years. Our net losses may fluctuate significantly from quarter to quarter and year to year depending on the progress of our clinical trials and the payment schedule between us and the CROs engaged by us. We anticipate that our expenses will increase significantly if and as we continue to develop and conduct clinical trials in our current indications with LBS-008, including our ongoing Phase 2 and Phase 3 trials in STGD1 and an anticipated Phase 2 or Phase 3 trial in dry AMD; initiate and continue research and preclinical and clinical development efforts for any future product candidates; leverage our exclusive RBP4 IP Portfolio to identify and develop additional product candidates and/or for additional indications; further expand our product pipeline through in-licensing or collaboration arrangements; seek regulatory and marketing approvals for our product candidates and complete clinical trials, if any; establish strategic collaborations or sales, marketing distribution and other commercial infrastructure in the future to commercialize any products for which we may obtain marketing approval; require the manufacture of larger quantities of product candidates for clinical development and, potentially, commercialization; maintain, expand and protect our intellectual property portfolio; hire and retain additional personnel, such as clinical and scientific personnel; add operational, financial and management information systems and personnel, including personnel to support our product development and help us comply with our obligations as a public company; and add equipment and physical infrastructure to support our research and development programs. In addition, upon the closing of this offering, we expect to incur additional costs associated with operating as a public company.

Our ability to become and remain profitable depends on our ability to generate product revenue. We do not expect to generate product revenue unless, and until, we enter into an out-license and/or collaboration agreement with others for, or we obtain marketing approval for, and commercialize, a product candidate, and we cannot assure you that we will ever generate revenue or profits.

Our current clinical development, manufacturing and commercialization plans and any of our future strategies for growth will be based on our ongoing assessment of macroeconomic trends and the evolving regulatory landscape.

#### **Key Factors Affecting Our Results of Operations**

Our results of operations, financial condition, and the year-to-year comparability of our financial results have been, and are expected to continue to be, principally affected by the below factors:

##### ***Costs and Expenses Structure***

Our results of operations are significantly affected by our cost structure, which primarily consists of research and development expenses and general and administrative expenses.

Research and development activities are central to our business model. We believe our ability to successfully develop product candidates will be the primary factor affecting our long-term competitiveness, as well as our future growth and development. Developing high-quality product candidates requires a significant investment of resources over a prolonged period of time, and a core part of our strategy is to continue making sustained investments in this area. Since our inception, we have focused our resources on our research and development activities, including developing our RBP4 IP Portfolio, conducting preclinical studies and clinical trials, and engaging in activities related to regulatory filings for our product candidates. Clinical studies become increasingly more expensive from Phase 1b/2 and onwards due to an increase in the number of subjects enrolled in such studies. Research and development costs are expensed as incurred. Costs for certain activities, such as activities performed by third-party contractors relating to the manufacturing and preclinical studies and clinical trials of our product candidates, are generally accrued based on our estimates of the actual services performed for a given period. These estimates are based on our evaluation of the progress to completion of specific tasks to be performed using information and data provided to us by our third-party contractors and vendors.

At this time, we cannot reasonably estimate the nature, timing and estimated costs of the efforts that will be necessary to complete the development of, or the period, if any, in which material net cash inflows may commence from, any of our product candidates. This is due to the numerous risks and uncertainties associated with developing such product candidates, including, but not limited to, the uncertainty of:

- the scope, rate of progress and expense of our research and development activities;
- successful completion of clinical trials, including the successful enrollment in such clinical trials, and clinical trial results;
- our ability to market, commercialize and achieve market acceptance for any of our product candidates, whether alone or in collaboration with others;
- our ability to establish manufacturing capabilities and capacities, whether internally or through CMOs, to the specifications of our product candidates for clinical supply;
- the potential benefits of our product candidates over other therapies;
- obtaining and maintaining patent, trade secret and other intellectual property protection and/or regulatory exclusivity for our product candidates;
- the terms and timing of regulatory approvals;
- successful completion of all safety studies required to obtain regulatory approval in the United States and other applicable jurisdictions for our product candidates; and
- maintaining a continued acceptable safety profile of the product candidates following regulatory approval.

A change in the outcome of any of these variables with respect to the development of any of our product candidates could mean a significant change in the costs, timing and viability of the development of that product candidate. For example, if we are required to conduct additional clinical trials or other testing of any of our product candidates beyond those that are contemplated or if we experience significant delays in enrollment in any clinical trials, we could incur significant additional costs and the clinical development timeline for our product candidates may be delayed. We expect research and development costs to continue to increase for the foreseeable future as we expand our operations and our development of product candidates progresses, including as we continue to support and advance the clinical trials of our product candidates.

Our general and administrative expenses consist primarily of employee salaries and related benefit costs, including share-based compensation expenses, for personnel in executive, finance, accounting and administrative functions. Other general and administrative expenses include professional fees for financial advisory, auditing and legal services. We expect our general and administrative headcount and related expenses to increase in the future to support our clinical program and research and development efforts, and the commercialization of our product candidates in the event approval is obtained. We also anticipate that our general and administrative expenses will increase as we operate as a public company following the completion of this offering.

#### ***Funding for Our Operations***

During the periods presented, we have funded our operations primarily through the issuance and sale of ordinary shares, convertible preferred shares in private placement transactions and convertible promissory notes. See “Description of Share Capital — History of Securities Issuances” for more information. However, if our business and our product candidate pipeline continue to expand, we may require further funding through public or private offerings, debt financing, collaboration, and licensing arrangements or other sources. Any fluctuation in our ability to fund our operations will impact our development plan, operating plan and our results of operations. In the event of the successful development and commercialization of one or more of our product candidates, we expect to fund our operations in part with revenue generated from sales of our commercialized drug products. In the event that we enter into out-license and/or collaboration arrangements with others, we expect to fund our operations in part with revenue received from such out-license and/or collaboration arrangements.

### ***Our Ability to Commercialize and/or Out-License Our Product Candidates***

Our business and results of operations depend on our ability to out-license our product candidates or, in the event any of our product candidates are approved for marketing by the respective regulatory authority in a country, commercialize such product candidates. Currently, our pipeline consists of our lead product candidate, LBS-008, which is currently in clinical development, and LBS-009, which is currently in preclinical development. Although we currently do not have any product approved for commercial sale and have not generated revenue from product sales or out-licensing, we expect to generate revenue either from sales of a product candidate if we complete the clinical development, obtain regulatory approval, and successfully commercialize such product candidate, or from out-licensing a product candidate if we enter into an out-license and/or collaboration agreement for any product candidate.

### **Key Components of Results of Operations**

#### ***Revenue***

To date, we have not generated any revenue. Our ability to generate revenue and to become profitable will depend upon the successful commercialization of, and/or our successful entry into out-license and/or collaboration arrangements in connection with, one or more of our product candidates. Because of the numerous risks and uncertainties associated with product development and regulatory approval, and out-license and/or collaboration arrangements, we are unable to predict the amount or timing of product revenue or out-license and/or collaboration revenue.

#### ***Research and Development Expenses***

Research and development expenses consist of costs associated with planning and conducting clinical trials of our product candidates. Our research and development expenses primarily consist of:

- payroll, share-based compensation and other related costs of personnel engaged in research and development activities;
- in-licensed patent rights fee of exclusive development rights of drugs granted to us under the Columbia License Agreement;
- costs for preclinical testing of our technologies and clinical trials such as payments to CROs and CMOs, investigators and clinical trial sites that conduct the clinical studies;
- costs to develop our product candidates, including raw materials and supplies, product testing, clinical trial equipment and its depreciation, and facility related expenses; and
- other research and development expenses.

Clinical trial costs are a significant component of our research and development expenses. Our current research and development activities primarily relate to the clinical development of LBS-008 for the following indications:

- ***STGD1.*** We are developing LBS-008 as an oral once-a-day treatment for STGD1. STGD1 is an inherited juvenile form of macular degeneration. As of the date of this prospectus, we have initiated our Phase 3 clinical trial, to evaluate the safety and efficacy of LBS-008 in adolescent STGD1 patients and received approval to commence patient enrollment in Taiwan, the U.K., Hong Kong and Switzerland. In addition, we are in the process of applying for the necessary approvals to conduct the same clinical trial in other relevant jurisdictions. We are also currently conducting our ongoing Phase 2 clinical trial. Previously, we completed a Phase 1b clinical trial of LBS-008 in adolescent patients with STGD1 and a Phase 1 clinical trial of LBS-008 in healthy adult subjects in mid-2020.
- ***Dry AMD.*** We are developing LBS-008 as an oral once-a-day treatment for dry AMD. Age-related macular degeneration, or AMD, is a common eye disorder among people over 50. The only approved therapies for AMD are for ‘wet’ AMD, which represents approximately 10% of all AMD cases. There are no approved therapies for the other stages of AMD, which are collectively referred to as dry AMD and represents approximately 90% of all AMD cases. We are currently evaluating our

plans to conduct a Phase 2 or Phase 3 trial in 2022 to evaluate the safety and efficacy of LBS-008 in the treatment of dry AMD. Previously, we completed a Phase 1 clinical trial of LBS-008 in healthy adult subjects in mid-2020.

We incurred research and development expenses of approximately \$7.4 million for the year ended December 31, 2021, representing approximately 75.7% of our total operating expenses for that period. Our research and development expenses may vary substantially from period to period according to the status of our research and development activities. The timing of expenses is impacted by the commencement of clinical trials and enrollment of patients in clinical trials. Clinical studies become increasingly expensive from Phase 1b/2 and onwards. We expect our research and development expenses to continue to increase for the foreseeable future, as we advance our lead product candidate, LBS-008, toward later stages and continue to expand our operations.

#### ***General and Administrative Expenses***

Our general and administrative expenses consist primarily of employee salaries and related benefit costs, including share-based compensation expenses, for personnel in executive, finance and administrative functions. Other general and administrative expenses include professional fees for financial advisory, auditing and legal services. For the year ended December 31, 2021, our general and administrative expenses amounted to approximately \$2.4 million.

We anticipate that our general and administrative expenses will increase in the future to support continued research and development activities, including our ongoing and planned research and development of our lead product candidate, LBS-008. We also expect to incur additional expenses as a result of operating as a public company, including expenses related to compliance with the rules and regulations of the SEC, additional insurance expenses, investor relations activities and other administrative and professional services.

#### ***Interest Income (Expenses)***

Interest income consists primarily of interest income derived from our cash. Interest expense consists primarily of accrued interest incurred pursuant to loans due to related parties.

#### ***Taxation***

##### ***Cayman Islands***

We are an exempted company with limited liability incorporated in the Cayman Islands. Under the current laws of the Cayman Islands, we are not subject to tax on income or capital gain. Additionally, upon payments of dividends by us to our shareholders, no Cayman Islands withholding tax will be imposed. However, we may be subject to taxation in other jurisdictions in which we operate, in particular, the United States, Australia, Hong Kong, and/or the PRC, where five of our wholly-owned subsidiaries are incorporated, if certain conditions are met under the laws and regulations of the Cayman Islands.

##### ***United States***

Our subsidiaries, Belite Bio Holdings Corp. and Belite Bio, LLC, which are both incorporated or formed in Delaware, United States, are subject to statutory U.S. Federal corporate income tax at a maximum rate of 21% for the year ended December 31, 2021. Both entities are also subject to state income tax in California at a rate of 8.84% for the year ended December 31, 2021.

##### ***Australia***

Our subsidiary, RBP4 Pty Ltd, is subject to Australia profits tax on the taxable income as reported in its respective statutory financial statements adjusted in accordance with the relevant Australia tax laws. The applicable tax rate in Australia is 30%. RBP4 Pty Ltd had no taxable income for the periods presented, therefore, no provision for income taxes has been provided.

**Hong Kong**

Our subsidiary, Belite Bio (HK) Limited, is subject to Hong Kong profits tax at a tax rate of 8.25% for assessable profits on the first HK\$2 million and 16.5% for any assessable profits in excess. No Hong Kong profit tax was provided for as there was no estimated assessable profit that was subject to Hong Kong profits tax for the year ended December 31, 2021.

**PRC**

Our subsidiary, Belite Bio (Shanghai) Limited is subject to the statutory rate of 25%, in accordance with the EIT Law. Under the EIT Law, dividends, interests, rent or royalties payable by Belite Bio (Shanghai) Limited to non-PRC resident enterprises, and proceeds from any such non-PRC resident enterprise investor's disposition of assets (after deducting the net value of such assets) shall be subject to a 10% withholding income tax, unless the respective non-PRC resident enterprise's jurisdiction of incorporation has a tax treaty or arrangements with China that provides for a reduced withholding income tax rate or an exemption from withholding income tax. No provision for PRC corporate income tax has been made for the year ended December 31, 2021, as Belite Bio (Shanghai) Limited had no such assessable profit for the year then ended.

**Results of Operations****Comparison of the Fiscal Years Ended December 31, 2020 and 2021**

The following table sets forth a summary of our consolidated results of operations for the years ended December 31, 2020 and 2021. This information should be read together with our consolidated financial statements and related notes included elsewhere in this prospectus. The operating results in any period are not necessarily indicative of the results that may be expected for any future period.

	For the Years Ended December 31,		Change	
	2020	2021		(%)
	(amounts in \$ and in thousands)			
<b>Expenses</b>				
Research and development <sup>(1)</sup>	3,688	7,419	3,731	101.2
General and administrative <sup>(1)</sup>	2,055	2,378	323	15.7
Total operating expenses	5,743	9,797	4,054	70.6
<b>Loss from operations</b>	<u>(5,743)</u>	<u>(9,797)</u>	<u>(4,054)</u>	<u>70.6</u>
<b>Other income (expense):</b>				
Interest income	12	5	(7)	(58.3)
Interest expense	(21)	—	21	100
Other income	—	126	126	
Total other (expense) income, net	(9)	131	140	1,555.6
<b>Loss before income tax</b>	<u>(5,752)</u>	<u>(9,666)</u>	<u>(3,914)</u>	<u>168.0</u>
Income tax expense	(1)	—	1	100
<b>Net loss</b>	<u>(5,753)</u>	<u>(9,666)</u>	<u>(3,915)</u>	<u>168.0</u>
<b>Other comprehensive income (loss)</b>				
Foreign currency translation adjustments, net of nil tax	6	(152)	(158)	(2,633.3)
<b>Total comprehensive loss</b>	<u>\$ (5,747)</u>	<u>\$ (9,818)</u>	<u>\$ (4,071)</u>	<u>\$ (70.8)</u>

(1) Total share-based compensation costs were recognized as follows for the year ended December 31, 2020 and 2021:

	Years ended December 31,	
	2020	2021
Research and development	\$ 77	\$ 52
General and administrative	1,286	1,478
<b>Total</b>	<b>\$1,363</b>	<b>\$1,530</b>

### Revenue

We did not generate any revenue during the years ended December 31, 2020 and 2021.

### Research and Development Expenses

The following table sets forth a breakdown of the major components of our research and development expenses in absolute amounts and as a percentage of our total research and development expenses for the years ended December 31, 2020 and 2021:

(in \$ thousands, except percentages)	For the Years Ended December 31,			
	2020		2021	
	\$	%	\$	%
Contracted research expenses and clinical trial expenses	1,979	53.7	6,384	86.0
Consultancy and professional service fees	319	8.6	492	6.6
Royalties	1,187	32.2	103	1.4
Other expenses	203	5.5	440	6.0
<b>Total</b>	<b>\$3,688</b>	<b>100</b>	<b>\$7,419</b>	<b>100</b>

Our research and development expenses increased by 101.2% from approximately \$3.7 million for the year ended December 31, 2020, to approximately \$7.4 million for the year ended December 31, 2021. The increase was primarily attributable to increased contracted research expenses and clinical trial expenses relating to our Phase 1b/2 and Phase 3 clinical trials to evaluate the safety and efficacy of LBS-008 in adolescent STGD1 patients, which were initiated in mid-2020 and 2021, respectively.

In the year ended December 31, 2021, approximately 86.0% of our total research and development expenses were attributable to contracted research expenses and clinical trial expenses. In the year ended December 31, 2020, approximately 53.7% of our total research and development expenses were attributable to contracted research expenses and clinical trial expenses. Clinical studies become increasingly more expensive from Phase 1b/2 and onwards. LBS-008 is currently undergoing a Phase 2 clinical trial and, as of the date of this prospectus, we have initiated a global Phase 3 clinical trial in adolescent STGD1 patients and received approval to commence patient enrollment in Taiwan, the U.K., Hong Kong and Switzerland. In addition, we are in the process of applying for the necessary approvals to conduct the same clinical trial in other relevant jurisdictions.

### General and Administrative Expenses

Our general and administrative expenses increased by approximately \$0.3 million from the year ended December 31, 2020, to the year ended December 31, 2021, which was primarily due to an increase in professional service fees incurred and an increase in our number of employees.

We expect these costs to increase materially in the near future, consistent with our plans to increase our headcount in conjunction with this offering and ongoing requirements as a public company.

### Interest Expense

We recorded approximately \$21,000 of interest expense for the year ended December 31, 2020, which comprised of the interest expense owing under the 2020 Lin BioScience Loan Agreement and the Cayman 2019 August Loan Agreement, and no interest expense for the year ended December 31, 2021. The change was



attributable to the loans under both the 2020 Lin BioScience Loan Agreement and the Cayman 2019 August Loan Agreement being repaid in full in July 2020.

#### ***Other Income***

We did not record any other income for the year ended December 31, 2020 and recorded approximately \$126,000 of other income for the year ended December 31, 2021. Other income primarily consists of foreign exchange gains resulting from transactions undertaken by our Australian subsidiary in its functional currency, the Australian dollar. The increase was attributable to the weakening of the Australian dollar against the U.S. dollar.

#### ***Foreign Currency Adjustments, Net***

We recorded a net foreign currency gain of approximately \$6,000 for the year ended December 31, 2020 and a net foreign currency loss of approximately \$152,000 for the year ended December 31, 2021. Foreign currency gain (loss) primarily results from the translation of the Australian dollar denominated financial statements of our Australian subsidiary into the U.S. dollar for consolidation purposes. The decrease was attributable to the weakening of the Australian dollar against the U.S. dollar which negatively impacted the Australian dollar denominated assets held by our Australian subsidiary.

#### **Liquidity and Capital Resources**

To date, we have not generated any revenues. We incurred net losses of approximately \$5.8 million and \$9.7 million for the years ended December 31, 2020 and 2021, respectively. Our primary use of cash is funding our research and development expenses. We used approximately \$4.4 million and \$7.5 million in cash for our operating activities for the years ended December 31, 2020 and 2021, respectively. We have financed our operations to date primarily through the issuance of our ordinary shares, the private placement of our convertible preferred stock and the issuance of our convertible promissory notes. For more information on our equity financing, see “Description of Share Capital — History of Securities Issuances.” As of December 31, 2021, we had cash of approximately \$17.3 million. Our cash consists primarily of demand deposits which is unrestricted as to withdrawal and use and have original maturities of less than three months.

Our lead product candidate, LBS-008, is still in clinical development. We expect our expenses to increase substantially as compared to prior periods in connection with our ongoing activities, particularly as we continue the development of and seek marketing approval for LBS-008 and, possibly, other product candidates. In addition, if we obtain marketing approval for LBS-008 or any other product candidate that we develop, and we choose to commercialize such product candidate ourselves, we expect to incur significant commercialization expenses related to product sales, marketing, distribution and manufacturing. Furthermore, upon the closing of this offering we expect to incur additional costs associated with operating as a public company. Accordingly, we anticipate that we will need substantial additional funding in connection with our continuing operations. These factors raise substantial doubt about our ability to continue as a going concern. Our financial statements have been prepared assuming that we will continue as a going concern, and do not include any adjustments to reflect the possible future effects on the recoverability and classification of assets, or the amounts and classification of liabilities that may result from our possible inability to continue as a going concern.

We expect that our expenses will continue to increase substantially and that we will continue to incur significant operating losses and negative operating cash flows as we fund both ongoing research and development activities and new activities as well as working capital needs. We have based our estimates on assumptions that may prove to be wrong, and we may use our available capital resources sooner than we currently expect or on alternative uses. Because of the numerous risks and uncertainties associated with the development and commercialization of our product candidates, we are unable to estimate the amounts of increased capital outlays and operating expenditures necessary to complete the development and commercialization of our product candidates.

After this offering, we may decide to enhance our liquidity position or increase our cash reserve for future operations and investments through additional financing. Our future capital requirements will depend on many factors, including:

- the number and development requirements of the product candidates we pursue;
- the scope, progress, timing, results and costs of discovering, researching and developing product candidates, and conducting preclinical studies and clinical trials;
- the scope, prioritization and number of our research and development programs;
- the costs, timing and outcome of regulatory review of our product candidates;
- the cost of manufacturing our product candidates and any products we commercialize, including costs associated with expanding our supply chain;
- the cost and timing of future commercialization activities, including product manufacturing, marketing, sales and distribution, for any of our product candidates for which we receive regulatory approval;
- the cash received, if any, from commercial sales of any product candidates for which we receive regulatory approval;
- our ability to establish and maintain strategic collaborations, licensing or other arrangements and the financial terms of such collaborations and arrangements;
- the extent to which we acquire or in-license other product candidates and technologies;
- our headcount growth and associated costs;
- the costs, timing and outcome of preparing, filing and prosecuting patent applications, maintaining and enforcing our intellectual property rights and defending any intellectual property-related claims;
- resources required to develop and implement policies and processes to promote ongoing compliance with applicable healthcare laws and regulations;
- the impact of COVID-19 on the initiation or completion of preclinical studies or clinical trials and the supply of our product candidates; and
- the costs of operating as a public company in the United States.

Until such time, if ever, as we can generate substantial product revenues, we expect to finance our cash needs through a combination of equity offerings, debt financings, collaborations, strategic alliances and marketing, distribution or licensing arrangements. To the extent that we raise additional capital through the sale of equity or convertible debt securities, your ownership interest will be diluted, and the terms of these securities may include liquidation or other preferences that adversely affect your rights as a holder of our ADSs. Debt financing and preferred equity financing, if available, may involve agreements that include covenants limiting or restricting our ability to take specific actions, such as incurring additional debt, making capital expenditures or declaring dividends. If we raise additional funds through collaborations, strategic alliances or marketing, distribution or licensing arrangements with third parties, we may have to relinquish valuable rights to our technologies, future revenue streams or product candidates or grant licenses on terms that may not be favorable to us. If we are unable to raise additional funds through equity or debt financings when needed, we may be required to delay, limit, reduce or terminate our product development or future commercialization efforts or grant rights to develop and market product candidates that we would otherwise prefer to develop and market ourselves. For additional information regarding the risks related to our need to obtain additional capital, see “Risk Factors — Risks Related to Our Financial Position and Need for Additional Capital — We have recorded net cash outflow from operating activities since our inception. Even if we consummate this offering, we will need to obtain additional financing to fund our operations. If we are unable to obtain such financing, we may be unable to complete the development and commercialization of our product candidates” and “Risk Factors — Risks Related to Our Financial Position and Need for Additional Capital — Raising additional capital may cause dilution to holders of our ADSs and our shareholders, restrict our operations or require us to relinquish rights to our technologies or product candidates.”

#### ***Operating Activities***

Net cash used in operating activities was approximately \$4.4 million for the year ended December 31, 2020 and consisted primarily of a net loss of approximately \$4.4 million, after non-cash add backs, offset

primarily by a decrease in prepayments of approximately \$0.2 million and a decrease in accrued expenses of approximately \$0.3 million. Net cash used in operating activities was approximately \$7.5 million for the year ended December 31, 2021 and consisted primarily of a net loss of approximately \$8.1 million, after non-cash add backs, offset primarily by an increase in accrued expenses of approximately \$0.6 million.

#### ***Investing Activities***

Net cash used in investing activities for the year ended December 31, 2020 was approximately \$20,000, which was comprised of an increase in prepayments of purchases of fixed assets.

Net cash used in investing activities during the year ended December 31, 2021 was approximately \$56,000, which resulted primarily from the purchase of fixed assets offset by the sale of certain fixed assets.

#### ***Financing Activities***

Net cash provided by financing activities was approximately \$28.1 million for the year ended December 31, 2020, which consisted primarily of proceeds from the issuance of our convertible preferred shares, the issuance of our ordinary shares and borrowings under the 2020 Lin BioScience Loan Agreement and the Cayman 2019 August Loan Agreement, partially offset by the repayment of loans due to related parties. The loans under both the 2020 Lin BioScience Loan Agreement and the Cayman 2019 August Loan Agreement were repaid in full in July 2020.

Net cash used in financing activities was approximately \$0.6 million for the year ended December 31, 2021, which consisted primarily of deferred offering costs, partially offset by the exercise of stock options.

#### **Contractual Obligations and Commitments**

We are party to an exclusive license agreement with Columbia University, which has been amended five times, most recently as of February 4, 2022, under which we license specified intellectual property from Columbia University. The patent rights licensed to us by Columbia University include issued patents with claims that recite a class of compounds directed to covering our planned lead compound, LBS-008, and specifically recite LBS-008. The license agreement requires us to make minimum annual royalty payments to Columbia University of (i) \$2.5 million on each of the second, third and fourth anniversaries of the first commercial sale of a licensed product and (ii) \$5 million on each anniversary of the first commercial sale of a licensed product, commencing on the fifth anniversary of such sale. We will also be obligated to pay single-digit earned royalties to Columbia University based on net sales of each licensed product by us and our affiliates and sublicensees. The minimum royalty payments will be creditable against the earned royalties accrued during the same calendar year. The license agreement obligates us to use commercially reasonable efforts to research, discover, develop and market licensed products for commercial sale and distribution and achieve certain development and regulatory approval milestones within certain timeframes, if certain milestones are achieved. We are also obligated to periodically inform Columbia University of our progress in meeting such milestones. The failure to achieve any such milestone would constitute a breach of the Columbia License Agreement. If we pay Columbia University the required fee, we will be granted a 6-month extension. As of the date of this prospectus, we have complied with the development and regulatory approval milestones under the Columbia License Agreement and requested no extensions. In the event that, after completion of Phase I Trials, there are unforeseen changes in clinical or regulatory development that we believe would affect the timely achievement of any milestone, we may request an extension from Columbia University for such milestone, which will not be unreasonably withheld or delayed. In the event that Columbia University does not agree to extend the deadlines to meet the milestones, and we are in breach for failure to timely meet the milestones or to make milestone or royalty payments, Columbia University may elect to convert our license to a nonexclusive license without the right to sublicense or initiate legal proceedings against third party patent infringers or terminate our license. We are also obligated to make payments to Columbia University in an aggregate amount of up to \$20 million based on achieving specified development and regulatory approval milestones and in an amount of up to \$25 million based on achieving a specified cumulative sales milestone with respect to the first licensed product. In addition, we are obligated to pay Columbia University a specified portion of revenue (other than royalties) we receive from sublicensees and a percentage of revenue in the low double-digits received from any sale of a priority review voucher by us or a sublicensee. In the event that we or a sublicensee do not sell a priority review voucher within one

year of receipt, the earned royalties that we would be obligated to pay to Columbia University based on net sales of licensed products would increase by 1%. We cannot reasonably estimate whether, when and in what amount any of such payments shall be made, but believe we are in compliance with the terms of the license. From inception through December 31, 2021, we have made a payment of \$1 million to Columbia University resulting from this license agreement, which was triggered by the completion of our Phase 1 clinical trial.

We also enter into cancelable contracts in the normal course of business with CROs for clinical trials, preclinical studies, manufacturing and other services and products for operating purposes. As of the date of this prospectus, the remaining contractual costs expected to be incurred in future periods for our clinical trials in STGD1 is approximately \$10.0 million.

#### **Off-Balance Sheet Arrangements**

We are not party to any off-balance sheet arrangements. We have not entered into any financial guarantees or other commitments to guarantee the payment obligations of any third parties. In addition, we have not entered into any derivative contracts that are indexed to our shares and classified as shareholder's equity or that are not reflected in our consolidated financial statements included elsewhere in this prospectus. Furthermore, we do not have any retained or contingent interest in assets transferred to an unconsolidated entity that serves as credit, liquidity or market risk support to such entity. We do not have any variable interest in any unconsolidated entity that provides financing, liquidity, market risk or credit support to us or engages in leasing, hedging or product development services with us.

#### **Quantitative and Qualitative Disclosures About Market Risks**

##### ***Interest and Credit Risk***

We are exposed to market risk related to changes in interest rates. We had cash of approximately \$17.3 million as of December 31, 2021. Interest-earning instruments carry a degree of interest rate risk and we are not exposed to other interest rate risk. We have not been exposed to material risks due to changes in interest rates, and we have not used any derivative financial instruments to manage our interest risk exposure.

Our credit risk is primarily attributable to cash. We mainly place or invest cash with reputable financial institutions in the jurisdictions where we and our subsidiaries are located. We do not believe that our cash has significant risk of default or illiquidity, and we will continually monitor the credit worthiness of these financial institutions. While we believe our cash does not contain excessive risk, future investments may be subject to adverse changes in market value.

Assets that potentially subject us to significant concentration of credit risk primarily consist of cash. We expect that there is no significant credit risk associated with our cash, which were held by reputable financial institutions in the jurisdictions where we and our subsidiaries are located. We believe that it is not exposed to unusual risks as these financial institutions have high credit quality.

##### ***Foreign Currency Exchange Rate Risk***

Our functional currency is U.S. dollars, but we contract with CROs and CMOs globally. We may be subject to fluctuations in foreign currency rates in connection with certain of these agreements. Transactions denominated in currencies other than the U.S. dollar are recorded based on exchange rates at the time such transactions arise. As of December 31, 2021, substantially all of our total liabilities were denominated in the U.S. dollar.

#### **Internal Control over Financial Reporting**

Prior to this offering, we have been a private company with limited accounting and financial reporting personnel and other resources to address our internal controls and procedures. In connection with the audit of our consolidated financial statements as of and for the year ended December 31, 2021, we and our independent registered public accounting firm identified one material weakness in our internal control over

financial reporting. The material weakness identified is our lack of formal policies and procedures to establish risk assessment processes and an internal control framework.

We are currently in the process of implementing a number of measures to address the material weakness identified, including: (i) preparing comprehensive accounting policies, manuals and closing procedures to improve the quality and accuracy of our period-end financial closing process; and (ii) appointing independent directors, establishing an audit committee, and strengthening corporate governance.

We may incur significant costs in the implementation of such measures. However, we cannot assure you that all these measures will be sufficient to remediate our material weaknesses in time, or at all. Additionally, we cannot assure you that we have identified all, or that we will not in the future have additional, material weaknesses. See “Risk Factors — Risks Related to This Offering and Our ADSs — If we fail to establish and maintain proper internal controls over financial reporting, our ability to produce accurate financial statements or comply with applicable regulations could be impaired.”

#### **Critical Accounting Policies and Estimates**

Our consolidated financial statements are prepared in accordance with U.S. GAAP. The preparation of our consolidated financial statements requires us to make estimates, assumptions and judgments that affect the reported amounts of assets, liabilities, costs and expenses. We base our estimates and assumptions on historical experience and other factors that we believe to be reasonable under the circumstances. We evaluate our estimates and assumptions on an ongoing basis. Our actual results may differ from these estimates. Our most critical accounting policies are summarized below. See Note 3 to our consolidated financial statements beginning on page F-1 of this prospectus for a description of our other significant accounting policies.

#### ***Research and Development Expenses***

Research and development expenses primarily include (1) payroll, share-based compensation and other related costs of personnel engaged in research and development activities, (2) in-licensed patent rights fee of exclusive development rights of drugs granted to us, (3) costs related to preclinical testing of the Company’s technologies and clinical trials such as payments to contract research organizations (“CRO”) and contract manufacturing organizations (“CMO”), investigators and clinical trial sites that conduct the clinical studies; (4) costs to develop our product candidates, including raw materials and supplies, product testing, clinical trial equipment and its depreciation, and facility related expenses, (5) other research and development expenses. Research and development expenses are charged to expense as incurred when these expenditures relate to the Company’s research and development services and have no alternative future uses.

As part of the process of preparing our financial statements, we are required to estimate our accrued expenses resulting from obligations under contracts with vendors, consultants and CROs, in connection with conducting research and development activities. The financial terms of these contracts are subject to negotiations, which vary from contract to contract and may result in payment flows that do not match the periods over which the services are provided under such contracts. We reflect research and development expenses in our consolidated financial statements by matching those expenses with the period in which services and efforts are expended. We account for these expenses according to the progress of the preclinical or clinical study as measured by the timing of various aspects of the study or related activities and determine accrual estimates through review of the underlying contracts along with discussions with research and other key personnel as to the progress of studies, or other services being conducted. During the course of a study, we adjust our rate of expense recognition if actual results differ from our estimates. Estimates for accrued research and development expenses are classified as accrued expenses on the accompanying consolidated balance sheet.

#### ***Share-Based Compensation***

##### *Awards Granted to Employees*

We grant share options to eligible employees, management and directors and accounts for these share-based awards in accordance with Accounting Standards Codification, or ASC, 718, *Compensation-Stock*

*Compensation.* Employees' share-based awards are measured at the grant date fair value of the awards and recognized as expenses a) immediately at grant date if no vesting conditions are required; b) using graded vesting method over the requisite service period, which is the vesting period, on a straight-line basis; or c) for share-based awards granted with performance condition, using graded vesting method over the period based on the expected milestone achievement dates. Share-based compensation expense is recorded in research and development and general and administrative expenses based on the classification of the work performed by the grantees.

Our determination of the fair value of share option on the date of grant utilized the Binominal Option Pricing Model with the assistance of an independent third party valuation firm. Grant date fair value was impacted by our ordinary share price as well as changes in assumptions regarding a number of subjective variables which included, but were not limited to, the expected term that options remained outstanding, the expected ordinary share price volatility over the term of the option awards, risk-free interest rates, and expected dividends.

To the extent the required vesting conditions are not met resulting in the forfeiture of the share-based awards, previously recognized compensation expense relating to those awards are reversed.

#### *Awards Granted to Non-Employees*

We have accounted for equity instruments issued to non-employees in accordance with Accounting Standards Update, or ASU, No. 2018-07, *Compensation — Stock Compensation (Topic 718): Improvements to Nonemployee Share-Based Payment Accounting*.

We recognize share-based compensation cost for equity awards to non-employees with a performance condition at the fixed fair value on date of grant over the period based on the expected milestone achievement dates as the derived service period (usually the vesting period), on a straight-line basis. We consider the probable outcome of that performance condition when determining share-based compensation expenses and will recognize a cumulative true-up adjustment if the probability of the conditions has changed.

The following table summarizes our share option activities under the 2020 Share Incentive Plan and the 2019 Share Incentive Plan for the years ended December 31, 2020 and 2021:

	Number of Options	Weighted Average Exercise Price	Weighted Average Grant Date Fair Value	Weighted Average Remaining Term (Years)	Aggregate Intrinsic Value
Outstanding as of January 1, 2020	1,335,794	\$0.1191	\$2.4720	9.96	3,301
Granted	2,807,381	\$0.4386	\$2.2574	—	—
Exercised	(727,676)	\$0.1191	\$2.4720	—	—
Forfeited or expired	(19,601)	\$0.1191	\$2.4733	—	—
Outstanding as of December 31, 2020	3,395,898	\$0.3832	\$2.2946	9.80	7,834
Granted	41,736	\$4.2254	\$0.4626	—	—
Exercised	(706,406)	\$0.3289	\$2.3311	—	—
Forfeited or expired	(748,667)	\$0.4386	\$2.2574	—	—
Outstanding Options, December 31, 2021	1,982,561	\$0.4626	\$2.2571	8.82	\$4,480
Vested and Expected to Vest Options as of December 31 2021	844,774	\$0.3935	\$2.3052	8.58	\$1,969
Exercisable Options as of December 31, 2021	356,067	\$0.2291	\$2.4192	7.99	\$ 891

Total unrecognized employee share-based compensation expense, which may be adjusted for actual forfeitures occurring in the future, were approximately \$2.6 million and \$0.8 million as of December 31, 2020 and December 31, 2021, respectively. The unrecognized compensation is expected to be recognized over a weighted-average period of 1.68 years and 2.77 years as of December 31, 2020 and December 31, 2021, respectively.

The fair value of options was determined using the Binomial Option Pricing Model, with assistance from an independent third-party appraiser. The binomial model requires the input of highly subjective

assumptions, including the expected volatility, the exercise multiple, the risk-free interest rate and the expected dividend yield. For expected volatility, we have made reference to historical volatility of several comparable companies in the same industry. The exercise multiple was estimated as the average ratio of the stock price to the exercise price of when employees would decide to voluntarily exercise their vested share options. As we did not have sufficient information of past employee exercise history, the exercise multiple was based on management's estimation. The risk-free rate for periods within the contractual life of the options is based on the market yield of U.S. Government Notes with a maturity life equal to the remaining maturity life of the options as of the valuation date. The expected dividend yield is based on our expected dividend policy over the contractual life of the options.

The assumptions used to estimate the fair value of the share options on the date of grant are as follows:

	As of December 17, 2019	As of December 23, 2020	As of March 1, 2021
Risk-free interest rate	1.72% – 1.74%	0.51%	0.87%
Expected volatility range	35.50% – 35.72%	36.59%	36.75%
Exercise multiple	2.8	2.8	2.8
Expected dividend yield	—	—	—

The following table summarizes total share-based compensation cost recognized:

	Years ended December 31,	
	2020	2021
Research and development	\$ 77	\$ 52
General and administrative	1,286	1,478
Total	<u>\$1,363</u>	<u>\$1,530</u>

### Recent Accounting Pronouncements

A list of recently issued accounting pronouncements that are relevant to us is included in Note 3 “Summary of Significant Accounting Policies — Recent Accounting Pronouncements” of our consolidated financial statements beginning on page F-1 of this prospectus.

### JOBS Act

In April 2012, the JOBS Act was enacted. Section 107 of the JOBS Act provides that an emerging growth company can take advantage of an extended transition period for complying with new or revised accounting standards applicable to public companies. This provision allows an emerging growth company to delay the adoption of certain accounting standards until those standards would otherwise apply to private companies. This transition period is only applicable under U.S. GAAP, which is the standard to which we prepare our consolidated financial statements.

We are in the process of evaluating the benefits of relying on other exemptions and reduced reporting requirements under the JOBS Act. Subject to certain conditions, as an emerging growth company, we intend to rely on all of these exemptions, including without limitation, (i) providing an auditor's attestation report on our system of internal controls over financial reporting pursuant to Section 404(b) of the Sarbanes-Oxley Act, (ii) complying with any requirement that may be adopted by the Public Company Accounting Oversight Board, regarding mandatory audit firm rotation or a supplement to the auditor's report providing additional information about the audit and the financial statements, known as the auditor discussion and analysis and (iii) complying with any new or revised financial accounting standards until such date that a private company is otherwise required to comply with such new or revised accounting standards. We will remain an emerging growth company until the earlier of (i) the last day of the fiscal year in which we have total annual gross revenues of \$1.07 billion or more; (ii) the last day of the fiscal year following the fifth anniversary of the date of the completion of this offering; (iii) the date on which we have issued more than \$1.0 billion in non-convertible debt during the previous three years; or (iv) the date on which we are deemed to be a large accelerated filer under the rules of the SEC, which means the market value of our common shares that are held by non-affiliates exceeds \$700.0 million as of the prior June 30th.

## BUSINESS

### Overview

We are a clinical stage biopharmaceutical drug development company focused on novel therapeutics targeting currently untreatable eye diseases involving retinal degeneration such as atrophic age-related macular degeneration (commonly known as dry AMD) and autosomal recessive Stargardt disease, or STGD1, both of which progressively lead to permanent blindness, and metabolic diseases such as non-alcoholic fatty liver disease, or NAFLD, nonalcoholic steatohepatitis, or NASH, type 2 diabetes, or T2D, and gout.

#### *LBS-008*

We believe our lead product candidate, LBS-008, or Tinlarebant, if approved, would provide a novel treatment option where there currently is none. LBS-008 is an oral once-a-day treatment that can reduce and maintain the delivery of vitamin A (retinol) to the eye as a means to reduce the accumulation of toxic vitamin A by-products in ocular tissue. This effect is achieved through the ability of LBS-008 to reduce and maintain the level of serum retinol binding protein 4, or RBP4, which carries retinol from the liver to the eye. In clinical trials, LBS-008 has demonstrated its target specificity and potency that we believe could be clinically meaningful to treat STGD1 patients. We initiated an open-label, dose-finding Phase 1b/2 clinical trial in adolescent STGD1 patients in mid-2020 in Australia and Taiwan. The study design includes two portions: Phase 1b and Phase 2. We have completed the Phase 1b portion of this study in 11 adolescent STGD1 patients which has extended into a two-year, Phase 2 study with 13 adolescent STGD1 patients in Australia and Taiwan. The preliminary data from the Phase 1b portion has shown that LBS-008 can achieve a mean RBP4 reduction of > 70%, relative to baseline values. We are currently conducting the Phase 2 portion of this study. See “—Phase 1b/2 Clinical Trial in STGD1” below for more information.

As of the date of this prospectus, we have initiated our Phase 3 clinical trial, to evaluate the safety and efficacy of LBS-008 in adolescent STGD1 patients and received approval to commence patient enrollment in Taiwan, the U.K., Hong Kong and Switzerland. In addition, we are in the process of applying for the necessary approvals to conduct the same clinical trial in other relevant jurisdictions.

STGD1 is a rare monogenetic juvenile-onset macular dystrophy that is characterized by the aberrant and excessive accumulation of toxic vitamin A by-products known as bisretinoids and cellular debris, or lipofuscin, which precedes the death of retinal tissue and loss of vision. Although an orphan disease, STGD1 is the most common juvenile macular degeneration. Dry AMD is a heterogenous condition that arises from a complex interplay between age, genetics and environmental factors, such as diet and smoking, but has a pathology and course of disease that strongly resembles that of STGD1, particularly in intermediate and advanced stages. There are no approved therapies for STGD1 or dry AMD.

Developed from our RBP4 intellectual property portfolio, or RBP4 IP Portfolio, LBS-008 was designed to be a potent and reversible RBP4 antagonist. As an RBP4 antagonist, LBS-008 reduces the amount of retinol entering the visual cycle thereby reducing the formation of bisretinoid toxins which will ultimately preserve the health of the retina. We hold a worldwide exclusive license of the RBP4 IP Portfolio from Columbia University, which contains disclosure directed to over 400 structurally distinct RBP4 antagonists under patent protection in major pharmaceutical markets worldwide, including the United States, the European Union, China, Australia, Japan, South Korea and India.

LBS-008 has received orphan drug designation for the treatment of STGD1 in the United States, which entitles it to market exclusivity such that the U.S. Food and Drug Administration, or FDA, may not approve any other applications for the same product for the same indication for 7 years, except in very limited circumstances. See “Regulations — U.S. Regulation — NDA Submission and Review — Orphan Drug Designation and Exclusivity” for more information. LBS-008 has also received orphan designation for the treatment of STGD1 in Europe, which entitles it to a 10 year period of market exclusivity, which may be reduced in certain circumstances. During this market exclusivity period, neither the European Medicines Agency, or EMA, nor the European Commission or the member states can accept an application for, or grant a marketing authorization for, a “similar medicinal product.” See “Regulations — European Regulation — Orphan Designation and Exclusivity” for more information. Additional benefits of an orphan drug



designation include a tax credit of 50% of the qualified clinical testing expenses for the relevant taxable year and a waiver of the new drug application, or NDA, application fee (which is approximately \$3.1 million for fiscal year 2022).

LBS-008 has also received rare pediatric disease designation in the United States and may be eligible for a priority review voucher. A priority review voucher may be awarded to a sponsor if it develops a drug for a rare pediatric disease and the drug is approved. The priority review voucher allows the sponsor of a subsequent NDA or Biologic License Application for any product candidate to expedite the FDA's review goal from 10 months to 6 months. The priority review voucher may be sold to other companies that seek to expedite drug reviews. See "Regulations — U.S. Regulation — NDA Submission and Review — Rare Pediatric Disease Designation and Priority Review Vouchers" for more information. In the last three years, priority review vouchers have sold in a price range between \$80-125 million. In the event that we or a sublicensee chooses to sell a priority review voucher, we or such sublicensee would be obligated to pay Columbia University a percentage of revenue in the low double-digits that we or such sublicensee receives from any such sale pursuant to the Columbia License Agreement. In the event that we or a sublicensee does not sell a priority review voucher within one year of receipt, the earned royalties that we would be obligated to pay to Columbia University based on net sales of licensed products would increase by 1%. See "Business — Intellectual Property — Patents — Patent License Agreement with The Trustees of Columbia University in the City of New York" for more information.

LBS-008 is the only drug candidate within the current drug development projects of the National Institute of Health (NIH) Blueprint Neurotherapeutics Network, or the BPN, that is intended to treat dry AMD. The BPN was launched in 2004 to foster small-molecule neurotherapeutic development, bringing together a unique blend of grant dollars, industry-standard scientific expertise, and contract resources under a milestone-driven cooperative agreement program. The BPN criteria for selection of clinical drug candidates are based on multiple features of an applicant's drug development program including the following: 1) strong biological rationale, 2) novel target for the disease, 3) strong data linking target to disease, 4) demonstration of preclinical pharmacodynamic effect and efficacy, 5) feasible path to clinic, and 6) IP free of roadblocks. LBS-008 was selected by the BPN in 2011 and, as of the date of this prospectus, is the only drug candidate within the current drug development projects of the BPN that is intended to treat dry AMD.

The mechanism of action utilized by LBS-008 has been recognized and recommended as a priority for clinical development in both STGD1 and dry AMD in a systematic review published by the U.K. National Institute for Health Research, or the NIHR, in 2018. The NIHR is funded by the U.K. Department of Health and Social Care and focuses on early translational research, clinical research and applied health and social care research for the purpose of enabling and delivering world-leading health and social care research that improves people's health and wellbeing and promotes economic growth. The NIHR screened 7,948 articles in 2018 for its systematic review on treatments for dry AMD and STGD1. Its principal findings included that research focus should be at earlier stages in both diseases (before vision is impaired) and that the most promising treatments for both diseases appear to be prevention of lipofuscin and bisretinoid accumulation. Therefore, the NIHR recommended the mechanism of RBP4 inhibition, which is utilized by LBS-008, as a promising treatment in dry AMD and STGD1.

Although there are currently no approved treatments available for macular degeneration, our competitors for LBS-008 include several companies going through clinical development for their product candidates. Based on publicly available information, we understand that there is one Japan-based pharmaceutical company that has an asset in Phase 3 development for STGD1. There are also three U.S.-based companies advancing treatments for STGD1 and their assets are currently in Phase 2 and Phase 2b development, respectively, with the third company having recently completed their Phase 2a trial. In geographic atrophy, or GA, there are five U.S.-based companies in late-stage clinical development, three of which have assets in Phase 3 development and two of which have assets in Phase 2 development.

#### *Clinical Trials in Healthy Adult Subjects*

To support the clinical development of LBS-008, we have completed one randomized, double-blind, placebo-controlled, Phase 1 SAD study in 40 healthy adult subjects in the United States, one randomized, double-blind, placebo-controlled, Phase 1 single ascending dose, or SAD, study in 39 healthy adult subjects

and one randomized, double-blind, placebo-controlled, Phase 1 multiple ascending dose, or MAD, study in 32 healthy adult subjects in Australia. These studies were conducted to confirm the safety, toxicity, pharmacokinetics, or PK, and pharmacodynamics, or PD of LBS-008 on a range of single ascending dose (10-50 mg in the US; 25-400 mg in Australia) / multiple ascending dose (5-25 mg in Australia) levels in healthy adult subjects in fasted / fed conditions.

In the US SAD study, we found that single doses of 10–50 mg LBS-008 were well tolerated and reduced mean serum RBP4 level by around 70% from baseline. The degree of lowering of RBP4 plasma concentrations increased with increasing LBS-008 dose. This study also compared doses of LBS-008 taken with and without food, which did not show a food effect with dosing.

In the Australian SAD study, we found that single doses of 25-400 mg LBS-008 were well tolerated and reduced mean RBP4 level by > 70% from baseline. One subject in the 100 mg cohort experienced a drug-related adverse event of mild transient xanthopsia. That event was resolved within 48 hours. A direct correlation between the LBS-008 plasma concentration and RBP4 suppression was observed.

In the Australian MAD study, we found that all dose levels were well tolerated and have identified an optimal daily dose to reduce serum RBP4 by >70% from baseline. Most drug-related adverse events reported were mild in severity, and the most frequently reported drug-related adverse event was asymptomatic Delayed Dark Adaptation, or DDA, which did not show dose proportionality and reflects a reduction in vitamin A levels in the eye, which is the intended effect of LBS-008. No deaths, serious or severe adverse events were reported. The Safety Review Committee, or SRC, approved dose escalations after reviewing the safety data profile at each dose level.

#### *Stargardt Disease*

In STGD1, we are developing LBS-008 as an oral daily treatment to target RBP4 by disrupting vitamin A (retinol) binding to RBP4 which leads to reduced delivery of retinol to the eye and reduced accumulation of toxic vitamin A by-products.

STGD1 is an inherited juvenile form of macular degeneration and currently, there is no approved treatment available. The disease is caused by a mutation in the ABCA4 gene, which leads to the accelerated formation and accumulation of toxic vitamin A by-products known as bisretinoids. The most prominent bisretinoid identified in human tissues is known as A2E (*N*-retinylidene-*N*-retinylethanolamine). The accumulation of A2E in ocular tissues causes progressive retinal cell death and permanent loss of vision. More than 500 mutations in the ABCA4 gene have been identified in STGD1 patients. Some STGD1 patients suffer severe visual impairment by the age of 20. The prevalence rate of STGD1 is estimated to be 1 in 10,000 people. Based on this estimate, approximately 30,000 US citizens are affected by STGD1. This estimate includes both adults and children. Although comprehensive epidemiological data on the prevalence of STGD1 in other countries is not available, the epidemiological literature from other countries, such as Europe and Asian countries, cite the 1 in 10,000 estimate for the prevalence of STGD1.

#### *Phase 1b/2 Clinical Trial in STGD1*

We have completed the Phase 1b portion of a Phase 1b/2 open-label, dose-finding study in 11 adolescent STGD1 patients which has extended into a two-year, Phase 2 study with 13 adolescent STGD1 patients in Taiwan and Australia. The Phase 1b portion is a dose-finding study designed to determine the optimal dose of LBS-008 and to evaluate safety, tolerability, PK and PD in adolescent STGD1 patients for a treatment period of 2 cycles of 14-day daily dosing of LBS-008 (28 days of daily treatment) and a 14-day follow-up period. Upon completion of Phase 1b, an optimal daily dose was identified and which was able to achieve a mean RBP4 reduction of > 70%, relative to baseline values.

The preliminary data shows that most frequently reported drug-related adverse events reported to date included DDA and transient xanthopsia, which were all graded as mild. Reports of transient DDA/night vision impairment and xanthopsia were anticipated and are consistent with LBS-008's mechanism of action. It is notable that in most incidences of DDA, it was confirmed by laboratory measure (dark adaptometry) as the majority of patients were asymptomatic. No deaths or serious or severe Treatment-emergent adverse events, or TEAEs, were reported. In addition, there were no clinically significant findings in relation to vital signs, physical exams, or electrocardiograms, or ECGs.

The Phase 2 portion consists of a 2-year treatment period with a follow-up period of one month. In the Phase 2 portion of the study, in addition to monitoring the safety and tolerability, we aimed to monitor PK and PD biomarkers (RBP4 and retinol) and the effects of treatment using various retinal imaging modalities (including definitely decreased autofluorescence, or DDAF, questionably decreased autofluorescence, or QDAF, Spectral-domain optical coherence tomography, or SD-OCT, and microperimetry), change in best-corrected visual acuity, or BCVA, and the relationship between the change in RBP4 levels and rate of lesion growth.

We are currently conducting the Phase 2 portion of this study. A total of 13 adolescent STGD1 patients were enrolled in the Phase 2 portion of the Phase 1b/2 study. As of the date of this prospectus, all 13 patients have received at least 6 months of treatment and completed the scheduled assessments at the first 6 month interval. Change in BCVA (early treatment diabetic retinopathy study, or ETDRS letter score), and fundus autofluorescence, or FAF, imaging results at 6-months are compared to the baseline measurements at the start of Phase 2. The preliminary data shows that 8 of the 13 patients (or 61.5%) recorded a gain in BCVA (ETDRS letter score) in at least one eye, including 2 patients who recorded a gain in BCVA in both eyes. The average BCVA from the 13 patients was an average loss of 2.8 letters in the right eye, and an average gain of 1.9 letters in the left eye. On FAF retinal imaging, 8 of the 13 patients (or 61.5%) had a reduction or no change in their QDAF area size in at least one eye, including 5 patients who had a reduction or no change in QDAF area size in both eyes. There was an average gain in QDAF area in the right eye of  $0.2 \pm 0.09\text{mm}^2$  (Mean  $\pm$  standard error of the mean, or SEM) and in the left eye of  $0.1 \pm 0.09\text{mm}^2$  (Mean  $\pm$  SEM). While 12 of the 13 patients had no DDAF lesion measured at the start of Phase 2 and at 6-months, 1 of the 13 patients had a DDAF lesion growth of  $0.3\text{mm}^2$  in both eyes during the 6-month period. On SD-OCT imaging, a gradual thinning with an average of approximately 7 to 10 microns (on total retinal thickness by ETDRS regions) was observed in both eyes. In the Ellipsoid Zone (EZ), an average increase in defect width of 0.26mm in the right eye and 0.61mm in the left eye were observed. However, 6 patients had a reduction in EZ defect width in at least 1 eye (including 3 patients in both eyes). Additional interim data read-outs will be captured at Months 12, 15, 18 and 21, and a final data read-out will be captured at Month 24.

#### *Phase 3 Clinical Trial in STGD1*

As of the date of this prospectus, we have initiated a randomized, double-masked, placebo-controlled, global, multi-center, Phase 3 clinical trial, to evaluate the safety and efficacy of LBS-008 in adolescent STGD1 patients and received approval to commence patient enrollment in Taiwan, the U.K., Hong Kong and Switzerland. In addition, we are in the process of applying for the necessary approvals to conduct the same clinical trial in other relevant jurisdictions. This study consists of a screening period, a treatment period of 2 years, and a follow-up period of one month. Approximately 60 patients are targeted for enrollment in this study with a 2:1 randomization (active:placebo). See “Risk Factors — In the event that we elect to carry out clinical trials in China and/or expand our operations into China in the future, we will be subject to changing legal and regulatory requirements in the PRC pharmaceutical industry, and new laws, rules and regulations may adversely affect our profitability or impose additional compliance burdens on us.”

We intend to focus on adolescent patients in our ongoing clinical trials due to several benefits afforded by utilizing this patient population — namely, establishing proof-of-concept in the context of a more severe and rapidly progressing disease (i.e., STGD1 disease progression is faster in adolescent patients compared to adults or later-onset patients), and the ability to readily expand into the larger adult STGD1 population upon approval (i.e., drug approvals for pediatrics and/or adolescents are accepted for adults but drug approvals for adults are not accepted for pediatrics and/or adolescent populations due to safety concerns).

#### *Dry AMD*

Due to the strong pathophysiologic similarities between STGD1 and intermediate to advanced stages of dry AMD, we expect LBS-008 to have a similar treatment effect on this population of dry AMD patients.

AMD is an age-related form of macular degeneration. The most commonly used classification system for AMD is the Age-Related Eye Disease Study, or AREDS, classification system, which designates the following categories:

- Category 1 is designated as “No AMD,” although there may be a few small (<63 $\mu\text{m}$  in diameter) yellowish subretinal deposits (i.e., drusen beneath the retina).

- Category 2 is designated as “Early AMD” and is characterized by multiple small drusen (<20µm in diameter), a few intermediate drusen (63-124µm in diameter), and abnormalities of the retinal pigment epithelium, or RPE, a monolayer of epithelial cells that lies beneath the retina and provides trophic and metabolic support to photoreceptor cells of the retina.
- Category 3 is designated as “Intermediate AMD,” where there is extensive intermediate drusen, large drusen (>125µm in diameter), or geographic atrophy (i.e., localized atrophy of the retina), or GA, and increased lipofuscin in the RPE.
- Category 4 is designated as “Advanced AMD” and is characterized by GA or neovascular maculopathy (i.e., ‘wet’ AMD).

The only approved therapies for AMD are for ‘wet’ AMD which represents approximately 10% of all AMD cases. There are no approved therapies for the other stages of AMD, including GA, secondary to advanced AMD, which are collectively referred to as dry AMD and represents approximately 90% of all AMD cases. Importantly, dry AMD is a leading cause of vision loss in older adults. Thus, there is a significant unmet medical need in treating dry AMD patients. There are an estimated 11 million dry AMD patients in the United States and over 196 million patients worldwide with an estimated global direct healthcare cost of US\$255 billion.

Disease progression in early dry AMD is very slow. The American Optometric Association reports that most people move through the process from diagnosis to legal blindness in about 10 years. Therefore, investigational therapies have been directed at the treatment of intermediate and advanced stages of dry AMD, which progress more rapidly than earlier stages. Unlike STGD1, dry AMD is believed to have a very heterogenous etiology, and various therapeutic approaches have been explored to slow disease progression in dry AMD. An important feature of Intermediate AMD is the aberrant and excessive accumulation of lipofuscin and bisretinoid toxins, similar to STGD1. In these stages of dry AMD, retinal lesions (i.e., GA) are bordered on all sides by an annulus of autofluorescence which expands in a centrifugal manner followed by lesion expansion into the autofluorescent area. *In vivo* analyses of the autofluorescent area in Intermediate AMD eyes revealed an excitation maxima and fluorescence emission that is consistent with the spectral properties of bisretinoid toxins. Thus, the clinical presentation and biochemical features of intermediate and advanced dry AMD suggest that a therapy directed at reducing the level of bisretinoid toxins may be effective to slow disease progression.

We are currently evaluating our plan to initiate, in 2022, a randomized, double masked, placebo-controlled, Phase 2 or Phase 3 trial, in the United States, Europe, and Asia Pacific. See “Risk Factors — In the event that we elect to carry out clinical trials in China and/or expand our operations into China in the future, we will be subject to changing legal and regulatory requirements in the PRC pharmaceutical industry, and new laws, rules and regulations may adversely affect our profitability or impose additional compliance burdens on us.” Our objective is to evaluate the efficacy and safety of LBS-008 in the treatment of dry AMD over the course of a two-year treatment period.

#### ***LBS-009***

LBS-009 is an anti-RBP4 oral therapy targeting liver disease, including NAFLD, NASH, and T2D.

NAFLD occurs when an excess accumulation of fat damages the liver. Currently, it is estimated that approximately 1.9 billion patients suffer from NAFLD worldwide. Over time, the liver damage and the associated inflammation can lead to the development of NASH, which impacts an estimate of more than 9 million patients in the United States alone. As the disease progresses, it can lead to cirrhosis and eventually, complete liver failure. NAFLD and NASH are a growing unmet need for which no FDA-approved treatments are currently available.

T2D is a chronic disease that occurs when the body cannot effectively use insulin, the hormone that regulates blood sugar levels. The health impact of T2D is profound, potentially causing damage to the eyes, heart, blood vessels, kidneys, and nerves. T2D is on the rise, with approximately 422 million patients globally.

LBS-009 is a small molecule designed to compete with retinol for RBP4 binding. When bound to LBS-009, RBP4 can no longer form a large molecular weight complex with transthyretin, or TTR.

Consequently, the RBP4/LBS-009 complex will be removed from circulation by renal filtration. We believe that modulating RBP4 concentrations systemically with LBS-009 has a significant therapeutic potential for treating patients suffering from metabolically associated diseases, including NAFLD, NASH and T2D.

LBS-009 is currently in preclinical development.

#### ***Our Management and Clinical Advisory Board***

Our management team and ophthalmology clinical advisory board have deep experience and capabilities in ophthalmology, neurology, immunology and immunotherapy, cardiovascular and renal medicine, oncology, neurobiology, biochemistry, drug discovery, clinical development, manufacturing, and commercialization. Our ophthalmology clinical advisory board includes key opinion leaders in the macular degeneration space, including Quan Nguyen, M.D., Professor of Ophthalmology at Stanford University, Hendrik P.N. Scholl, M.D., Professor and Chairman of the Department of Ophthalmology at University of Basel and Co-Director of the Institute of Molecular and Clinical Ophthalmology in Basel, Michel Michaelides, M.D., Consultant Ophthalmologist at Moorfields Eye Hospital and Professor of Ophthalmology, UCL Institute of Ophthalmology, Robyn Guymer, M.D., Professor of Ophthalmology, University of Melbourne and Deputy Director of the Centre for Eye Research Australia and Frank Holz, M.D., Chairman of Ophthalmology, University of Bonn. Together, our management team and ophthalmology clinical advisory board, in connection with our exclusive technology platform, will allow our drugs to be tailored to target at-risk patients across the United States and worldwide, who lack access to necessary treatment in the macular degeneration space.

#### **Our Program**

Our lead product candidate, LBS-008, is an RBP4 antagonist. We are developing LBS-008 as an oral daily treatment for STGD1 and dry AMD.

The following table summarizes key information about our clinical program for LBS-008:

<b>Indication</b>	<b>Clinical Trials</b>	<b>Trial Participants</b>	<b>Estimated Timeline</b>
STGD1	Phase 1 single and multiple ascending dose trial	Healthy adult subjects	Completed
	Phase 1b trial	Adolescent patients with STGD1	Completed
	Phase 2 trial	Adolescent patients with STGD1	Ongoing, with interim data read-outs expected to be captured every 6 months
	Phase 3 trial	Adolescent patients with STGD1	Initiated
Dry AMD	Phase 1 single ascending dose trial	Healthy adult subjects	Completed
	Phase 2 or Phase 3 trial	Patients with dry AMD	2022

#### **Our Strengths**

We believe we are well placed to accomplish our mission due to the following strengths:

##### ***Novel oral therapy to tap into a niche market for significant unmet medical needs.***

LBS-008 is an orally administered, non-retinoid, small molecule antagonist of RBP4 that shows nanomolar potency and a pharmacodynamic effect that is readily reversible upon drug cessation. LBS-008 is intended as a once-a-day treatment to reduce the accumulation of vitamin A-based cytotoxins known as bisretinoids and slow disease progression in STGD1 and dry AMD.

***Pre-clinically and clinically demonstrated mechanism of action.***

The LBS-008 mechanism of action has demonstrated both preclinical and clinical proof-of-concept. In the preclinical studies, treatment with LBS-008 showed a clear correlation between reduction of serum RBP4, reduction of bisretinoid cytotoxins in the eye, and photoreceptor preservation in a relevant animal model (i.e., *Abca4<sup>-/-</sup> / Rdh8<sup>-/-</sup>* mice). The clinical significance of this therapeutic approach was realized in a 2-year Phase 2 clinical trial of fenretinide (a retinoid-based RBP4 antagonist) in GA secondary to dry AMD. In that study, subjects achieving a > 70% reduction of RBP4 showed a statistically significant slowing of lesion growth at the end of the study.

***Receipt of Orphan Drug Designation in the United States and Europe.***

LBS-008 has received orphan drug designation in the United States and Europe, which entitles it to market exclusivity such that the FDA may not approve any other applications for the same product for the same indication for 7 years, except in very limited circumstances, and the EMA, the European Commission and each of the member states may not accept an application for, or grant a marketing authorization for, a “similar medicinal product” for 10 years, which may be reduced in certain circumstances. See “Regulations — U.S. Regulation — NDA Submission and Review — Orphan Drug Designation and Exclusivity” and “Regulations — European Regulation — Orphan Designation and Exclusivity” for more information. Additional benefits of an orphan drug designation include a tax credit of 50% of the qualified clinical testing expenses for the relevant taxable year and a waiver of the NDA application fee (which is approximately \$3.1 million for fiscal year 2022).

***Receipt of Rare Pediatric Disease Designation in the United States with Eligibility for Priority Review Voucher if approved.***

LBS-008 has received rare pediatric disease designation in the United States and may be eligible for a priority review voucher. A priority review voucher may be awarded to a sponsor if it develops a drug for a rare pediatric disease and the drug is approved. The priority review voucher allows the sponsor of a subsequent NDA or Biologic License Application for any product candidate to expedite the FDA’s review goal from 10 months to 6 months. The priority review voucher may be sold to other companies that seek to expedite drug reviews. See “Regulations — U.S. Regulation — NDA Submission and Review — Rare Pediatric Disease Designation and Priority Review Vouchers” for more information. In the last three years, priority review vouchers have sold in a price range between \$80-125 million. In the event that we or a sublicensee chooses to sell a priority review voucher, we or such sublicensee would be obligated to pay Columbia University a percentage of revenue in the low double-digits that we or such sublicensee receives from any such sale pursuant to the Columbia License Agreement. In the event that we or a sublicensee does not sell a priority review voucher within one year of receipt, the earned royalties that we would be obligated to pay to Columbia University based on net sales of licensed products would increase by 1%. See “Business — Intellectual Property — Patents — Patent License Agreement with The Trustees of Columbia University in the City of New York” for more information.

***National Institute of Health Blueprint Neurotherapeutics Network sponsored and endorsed.***

LBS-008 is the only drug candidate within the current drug development projects of the BPN that is intended to treat dry AMD. The BPN was launched in 2004 to foster small-molecule neurotherapeutic development, bringing together a unique blend of grant dollars, industry-standard scientific expertise, and contract resources under a milestone-driven cooperative agreement program. The BPN criteria for selection of clinical drug candidates are based on multiple features of an applicant’s drug development program. LBS-008 was selected by the BPN in 2011 and, as of the date of this prospectus, is the only drug candidate within the current drug development projects of the BPN that is intended to treat dry AMD.

***U.K. National Institute for Health Research endorsed the mechanism of action utilized by LBS-008.***

The NIHR commissioned a systematic review of 7,948 articles in 2018 to identify therapeutic approaches that would have the greatest chance to provide a treatment effect in STGD1 and dry AMD. Antagonism of RBP4, via the LBS-008 mechanism of action, was recommended as a priority for clinical development in both STGD1 and dry AMD. This decision was based upon the clear biological rationale and a well-defined mechanism of action which has demonstrated both preclinical and clinical proof-of-concept.

***Potential to treat intermediate to advanced-stage dry AMD with oral therapy for lifetime.***

Invasive treatments such as intravitreal injections and gene therapies pose a very high risk for early to intermediate-stage dry AMD patients as these individuals are typically asymptomatic or show very mild symptoms. The treatment modalities that are acceptable for these disease stages, i.e., prior to advanced stage AMD, are non-invasive, self-administered treatments such as oral and topical medications (such as eye drops) that are suitable as daily treatments for chronic slowly progressive diseases such as AMD. However, topical treatments are more suitable for diseases and disorders at the front of the eye as they are unlikely to reach the back of the eye where the disease is localized in dry AMD. As the accumulation of bisretinoid toxins and lipofuscin in dry AMD is a slowly evolving process, any effective treatments would need to be administered during the entire course of disease as these treatments would not be expected to be curative. LBS-008 was developed to be a potent and reversible RBP4 antagonist intended for long-term daily oral administration. Importantly, long-term (5-year) reduction of RBP4 with a retinoid-based RBP4 antagonist (fenretinide) in pre- and post-menopausal women was determined by the study authors to be well-tolerated. The strong pathophysiologic similarities between dry AMD and STGD1 (i.e., early accumulation of bisretinoid toxins which leads to dysfunction or death of the RPE, followed by photoreceptor cell death) suggests that LBS-008 would be effective in both diseases as a long-term treatment.

***Highly experienced senior management team supported by world-renowned advisory board and influential key opinion leaders.***

Our senior management team is comprised of highly experienced research scientists, clinician scientists, and business development experts who have decades of clinical development experience. This team is supported by a world-renowned advisory board of ophthalmologists and retinal specialists and influential key opinion leaders.

***Our Strategies***

Our goal is to become a leading biopharmaceutical company with an aim to develop the first approved treatment on STGD1 and dry AMD globally. We intend to accomplish our mission by pursuing the following growth strategies:

- ***Efficiently advance our lead product candidate, LBS-008, through Phase 2 and Phase 3 clinical development in adolescent STGD1 patients and regulatory approval, with the potential to establish a new standard of care for STGD1 patients.*** We are developing LBS-008 as an oral daily treatment for STGD1. The Phase 1b portion of our Phase 1b/2 clinical trial for STGD1 patients has shown that LBS-008 can achieve a mean RBP4 reduction of > 70%, relative to baseline values. We are currently conducting the Phase 2 portion of this study. See “—Phase 1b/2 Clinical Trial in STGD1” above for more information. As of the date of this prospectus, we have initiated our Phase 3 clinical trial, to evaluate the efficacy and safety of LBS-008 in adolescent STGD1 patients over the course of a two-year treatment period and received approval to commence patient enrollment in Taiwan, the U.K., Hong Kong and Switzerland. In addition, we are in the process of applying for the necessary approvals to conduct the same clinical trial in other relevant jurisdictions.
- ***Leverage the promising clinical data of LBS-008 in adolescent STGD1 patients to initiate Phase 2 or Phase 3 clinical development in dry AMD.*** We have chosen to strategically prioritize our clinical development efforts in adolescent STGD1 patients before pursuing clinical development in adult patients with dry AMD. Clinical research has shown that there is a higher rate of disease progression and rapid deterioration of visual function in childhood-onset STGD1, compared to adult-onset STGD1 and GA in dry AMD. This suggests that therapeutic intervention in an adolescent population would provide an increased likelihood of observing a treatment effect, compared to adult-onset retinal degenerations. Additionally, because of the strong pathophysiologic similarities between STGD1 and dry AMD, a positive treatment effect of LBS-008 in adolescent STGD1 patients would provide a margin of de-risk for a subsequent clinical trial in GA. The Phase 1b portion of our Phase 1b/2 clinical trial for STGD1 patients has shown that LBS-008 can achieve a mean RBP4 reduction of > 70%, relative to baseline values. Based on this clinical activity, we believe that LBS-008, if approved, will also have therapeutic value in treating dry AMD. We are currently evaluating our



plans to initiate a Phase 2 or Phase 3, randomized, double masked, placebo-controlled, global, multi-center trial for dry AMD in 2022 to evaluate the efficacy and safety of LBS-008 over the course of a two-year treatment period.

- **Potentially advance LBS-009 through clinical development for the treatment of NAFLD and NASH.** If we obtain the necessary funding, we may develop LBS-009 as an oral treatment for NAFLD and NASH. LBS-009 is currently in preclinical development.
- **Continue to leverage our exclusive RBP4 IP Portfolio, and look for additional in-licensing or collaboration arrangements, to identify novel candidates to further expand our product pipeline and utilize our global organizational structure to advance programs into clinical development in a capital efficient manner.** We plan to continue to utilize our exclusive RBP4 IP Portfolio, as well as search for additional in-licensing or collaboration arrangements, to isolate promising and novel drug compounds to expand our therapeutic pipeline. Additionally, we believe our global organizational structure will ultimately lead to significant revenue and cost advantages in the discovery, development and commercialization of our innovative therapeutics.
- **Evaluate strategic collaborations to maximize the value of our product candidates.** We hold the worldwide development and commercial rights to our pipeline programs, and we intend to out-license our product candidates or commercialize our product candidates, if approved, in key territories. We may selectively enter into global or regionally focused strategic partnerships around certain targets, product candidates, or disease areas if we believe these collaborations could accelerate the clinical development and maximize the value of our product candidates, ultimately expanding patient access.

### Research and Development and Technology

The retina is a thin sheet of nerve tissue which lies along the back inside wall of the eye. Within the retina are two types of light-sensitive cells called photoreceptors. The light-sensing chemical molecule which rods and cones depend upon for proper functioning is delivered by an underlying tissue called the retinal pigment epithelium, or RPE. The RPE maintains the health and viability of photoreceptors by providing other nutrients from the blood and by ingesting the spent distal tips of rods and cones in a process called phagocytosis. The phagocytosis process is particularly important as it facilitates removal of toxic metabolites of vitamin A and other cellular material which has become heavily oxidized due to chronic light exposure. Under normal physiologic conditions, these metabolites are removed from the photoreceptors and transferred to the RPE for detoxification and recycling. It is theorized that, within a subset group of individuals predisposed to develop AMD, the removal and/or recycling process may be compromised. In this condition, the vitamin A metabolites linger within photoreceptors and spontaneously react with other cellular material resulting in chemically stable, toxic entities. These toxins then enter the RPE through the normal physiologic process of phagocytosis and inevitably poison the RPE. The toxins which accumulate within the RPE are derived primarily from vitamin A. Therefore, reducing the level of vitamin A circulating within the eye would be expected to reduce the toxic burden placed upon the RPE. An animal model which demonstrates excess accumulation of lipofuscin and vitamin A based toxin, known as A2E was utilized to determine whether the modulation of vitamin A entering RPE would be an effective therapeutic approach.

#### *Mechanism of Action*

Both STGD1 and dry AMD are characterized by the early aberrant accumulation of lipofuscin and cytotoxic bisretinoids. The most abundant autofluorescent bisretinoid that has been identified in human lipofuscin is known as A2E (*N*-retinylidene-*N*-retinylethanolamine), a spontaneously formed complex comprised of two molecules of retinal and one molecule of ethanolamine. Investigations of the potential toxicity of A2E in cell-based assays and animal models have shown that this compound is highly toxic and can kill RPE cells in a concentration-dependent manner through myriad mechanisms. Because A2E and related bisretinoids are derived from vitamin A (i.e., they are by-products of normal visual cycle function), therapeutic approaches have focused on reducing levels of vitamin A (retinol) in the eye. One approach that has been effective to reduce A2E and lipofuscin in a mouse model of STGD1 (i.e., *Abca4*<sup>-/-</sup> / *Rdh8*<sup>-/-</sup> mice) is based on reducing delivery of dietary retinol to the eye. In that mouse model, LBS-008 significantly reduced the accumulation of bisretinoid toxins that are known to cause STGD1 and have been implicated



in progression of dry AMD. Importantly, treatment of *Abca4<sup>-/-</sup> / Rdh8<sup>-/-</sup>* mice with LBS-008 also prevented photoreceptor loss, which is believed to be caused by excessive levels of bisretinoid toxins.

LBS-008 is a potent, orally administered small molecule RBP4 antagonist that has been specifically designed to reduce the delivery of retinol to the eye as a therapeutic approach towards reducing the accumulation of cytotoxic bisretinoids, preserving the integrity of retinal tissues, and ultimately slowing or preventing loss of vision. The delivery of retinol to the RPE requires RBP4 and the RPE expresses a specific RBP4 receptor (STRA6) to regulate vitamin A uptake. Other extrahepatic tissues do not require delivery of retinol bound to RBP4 and do not express the RBP4 receptor. These tissues are able to take up vitamin A bound to non-specific carriers such as lipoproteins, triglycerides, and albumin.

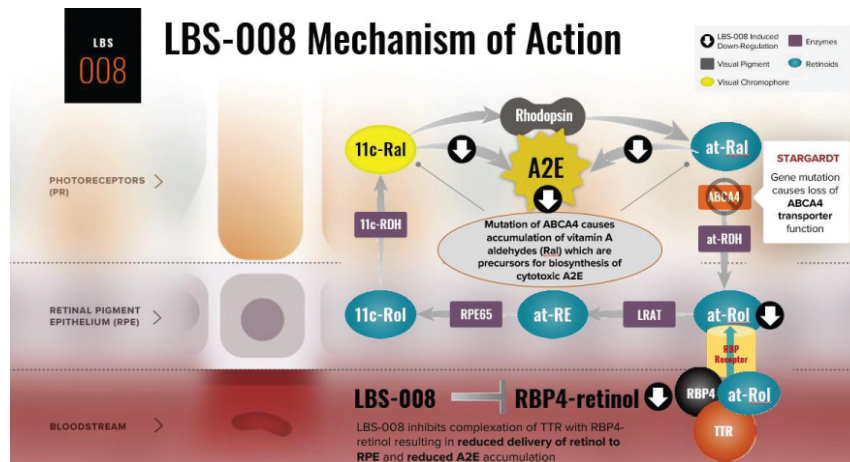

#### *Pathophysiologic Similarities in STGD1 and Intermediate to Advanced Dry AMD*

Early *in vivo* measurements of lipofuscin in STGD1 patients revealed an intrinsic autofluorescence which is localized to the RPE. A comprehensive biochemical analysis of post-mortem retinal tissue from STGD1 patients has shown a high concentration of bisretinoid compounds (vitamin A-based dimers) which would likely confer autofluorescence to lipofuscin due to the light absorbing and light emitting properties of these compounds. Thus, the intrinsic autofluorescent properties of lipofuscin in STGD1 can be attributed to the high concentrations of fluorescent vitamin A byproducts within lipofuscin particles. Importantly, this unique feature allows clinicians to diagnose and monitor the extent of retinal disease in STGD1 patients using fundus autofluorescence, or FAF, photography. In a recent prospective cohort study of childhood-onset STGD1 ( $n = 71$  subjects; mean age of onset  $9.6 \pm 3.4$  years), FAF photography was found to be a robust structural outcome measure. In that same study, a high rate of progression was observed in childhood-onset disease, making this subtype of STGD1 ideally suited to be considered for prioritization in clinical trials.



An additional indication under consideration for LBS-008 is GA in dry AMD. This additional indication was selected based upon the strong pathophysiologic similarities between STGD1 and GA, which includes the aberrant and excessive accumulation of vitamin A-based toxins and cellular debris within ocular tissue.

The figure below shows a series of FAF images from a patient with late-onset STGD1 (top panels) and a patient with GA (lower panels). The images were taken at Baseline and at 4 subsequent time points out to 57 months and 55 months, for STGD1 and GA, respectively. In each of the images for the STGD1 patient and the GA patient, the central lesion is surrounded on all sides by autofluorescence which is consistent with the excitation/emission properties of A2E and related bisretinoids. In each patient, the pattern of disease progression from Baseline shows that as the autofluorescence grows in intensity and area, the lesioned tissue follows. Additionally, in the GA patient, the 'evolution' of areas of autofluorescence into lesioned tissue can be clearly seen. It is also important to note that in each disease the loss of visual acuity does not track with the expansion of lesioned tissue. This is due to a phenomena of foveal sparing in both diseases which preserves the small area of tissue in the center of the retina that is responsible for conferring high visual acuity. In addition, as lesions encroach into the fovea, STGD1 and GA patients tend to utilize 'eccentric fixation' in which areas just peripheral to the fovea (non-lesioned retina) are used for reading and high visual acuity.

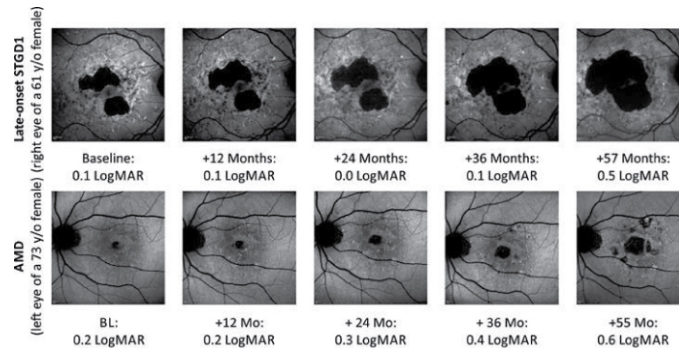

#### *Proof of Concept from Fenretinide*

Our confidence that reduction of serum RBP4 will be a viable treatment approach in STGD1 and GA comes from prospective clinical analyses of the natural history of disease progression in these diseases, and the findings from a 2-year Phase 2 proof-of-concept study that was conducted in dry AMD patients with GA. Fenretinide was selected for the study because of a prominent side effect that had been observed in subjects treated with fenretinide in various clinical oncology studies, a dose-dependent reduction in serum RBP4-retinol, due to its structural and chemical similarity to retinol.

Fenretinide (*N*-(4-hydroxyphenyl) retinamide; also known as 4-HPR) is an analog of all-*trans* retinoic acid (ATRA) first synthesized in the late 1960s as an antineoplastic drug. The Phase 2 GA fenretinide study was a randomized, double-blind, placebo-controlled study with 246 subjects randomized into one of three treatment arms: placebo, 100 mg, or 300 mg. In this study, patients in the 300 mg group who achieved RBP4 levels of  $\leq 1 \mu\text{M}$ , which is equivalent to approximately 70% reduction of RBP4, showed a mean reduction of  $0.33 \text{ mm}^2$  in the yearly lesion growth rate compared with subjects in the placebo group ( $1.70 \text{ mm}^2/\text{year}$  vs.  $2.03 \text{ mm}^2/\text{year}$ , respectively). However, due to its poor bioavailability and significantly lower affinity towards RBP4 as compared to LBS-008, and therefore weaker potency, only a small subset of GA subjects achieved the criterion. Based on this data, we believe a sustained  $>70\%$  reduction of RBP4 from baseline would provide the greatest potential for a treatment benefit and, therefore, represents the ‘therapeutic threshold’ to achieve in future clinical studies directed at reducing the accumulation of A2E and related bisretinoids as a means of preserving retinal tissue and functional vision.

#### *Safety of Long-Term RBP4 Inhibition*

In March 1987, a Phase 3 trial was initiated to assess the efficacy of a 5-year treatment regimen with fenretinide in reducing contralateral or second ipsilateral breast cancer in patients aged 30-70 years with early breast cancer, who had received no systemic treatment after primary treatment. A total of 2,867 assessable patients completed the intervention period by July 1998.

Women were randomly assigned to receive no treatment (1,435 patients) or 5-year fenretinide treatment (1,432 patients). Fenretinide was administered in a gelatin capsule (200 mg) and was taken daily at dinner with a two-day drug holiday on weekends. Compared to baseline, plasma retinol levels decreased by a mean of approximately 71% (range: 61% – 88%) during fenretinide administration ( $P < 0.0001$ ). Mean plasma retinol concentrations during fenretinide treatment were  $\leq 1 \mu\text{M}$ . Following the 5-year treatment regimen, a 28-day treatment cessation period was effective to restore retinol to baseline values.

In terms of disease recurrence in the breast, the trial showed a possible beneficial effect of the compound in premenopausal women, and an opposite trend in postmenopausal women. End points considered for safety assessment were the occurrence of delayed dark adaptation, or DDA, dermatologic disorders, gastrointestinal symptoms, disorders of the ocular surface, and abnormal laboratory values.

A comprehensive analysis of the safety data showed that the most common adverse events were DDA (cumulative incidence, 19.0%) and dermatologic disorders (18.6%). Less common events were gastrointestinal symptoms (13.0%) and disorders of the ocular surface (10.9%). In comparison, incidence figures in the control arm were 2.9% for DDA, 2.9% for dermatologic disorders, 5.4% for gastrointestinal symptoms, and 3.2% for disorders of the ocular surface. Symptoms occurring during fenretinide treatment tended to recover with time. No between-group difference was observed for the occurrence of laboratory data abnormalities. Overall, only 63 (4.4%) treatment discontinuations were caused by adverse events.

The investigators of the study noted that given the large number of patients involved in the study and the prolonged (i.e., over 5 years) intake of the drug, the experience on fenretinide tolerability can be considered reasonably reassuring. The observed clinical symptoms were often of minor importance, tended to recover spontaneously, and required permanent treatment discontinuation in a minority of cases.

#### ***Stargardt Disease***

##### ***Background***

Autosomal recessive STGD1 is a rare monogenetic juvenile-onset macular dystrophy that is characterized by the aberrant and excessive accumulation of toxic vitamin A by-products and cellular debris which precedes the death of retinal tissue and loss of vision. STGD1 is the most common inherited retinal dystrophy, affecting roughly 1 in 10,000 people. This prevalence rate computes to approximately 30,000 STGD1 patients in the United States. The disease is typically diagnosed at a young age, often starting during childhood or adolescence, and is characterized by lesions within retinal tissue which cause severe and irreversible loss of visual acuity gradually leading to legally defined blindness at a very young age. Older age at onset ( $>20$  years of age) is associated with slower disease progression. There are no FDA-approved treatments for STGD1.

Individuals affected with STGD1 harbor mutations in a retina-specific ATP-binding cassette, or ABC, transporter gene, known as *ABCA4*. The *ABCA4* gene encodes an ATP-dependent transporter, known as ABCA4, or Rim Protein. This protein resides at the rim of rod and cone photoreceptor disc membranes where it removes light-activated or 'bleached' visual chromophore (all-trans retinal) from the retina permitting detoxification by a retinal dehydrogenase (RDH8) which, in turn, allows recycling within the underlying RPE. The primary function of the RPE is to provide metabolic and trophic support to sustain health and integrity of the retina. The intimate association of the RPE with outer segments of rod and cone photoreceptors facilitates this function.

The RPE converts dietary vitamin A delivered from the blood circulation, and recycled retinol liberated from the retina following exposure to light, into visual chromophore (11-cis retinal). The visual chromophore is then transferred to the retina to maintain light sensitivity and function of the retina. The enzymatic conversion of dietary vitamin A to a light-sensitive visual chromophore is a unique process which only occurs within RPE cells and the ABCA4 protein plays a key role in this process — see figure below.

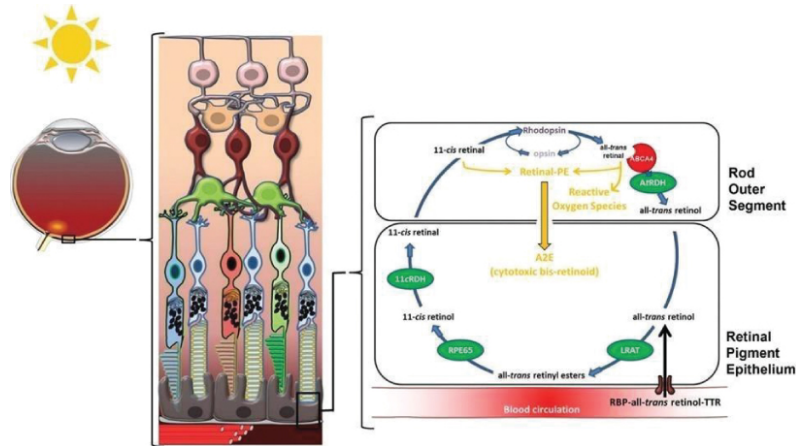

The processing of vitamin A (aka, retinol, or all-trans retinol) in the visual cycle begins with the delivery of circulating retinol to the RPE. The ternary complex of RBP4-retinol-TTR is presented to RBP4 receptors which are located on the basal surface of RPE. The RBP4-TTR vehicle serves to solubilize retinol and produce a large molecular size complex which resists elimination in the kidney. Upon entry into the RPE, retinol undergoes a series of enzymatic reactions resulting in generation of the visual chromophore, 11-cis retinal. The visual chromophore is delivered to the retina where it combines with opsin to form the light-sensitive visual pigment, rhodopsin. Photoactivation of rhodopsin liberates all-trans retinal which is transported out of the retina by the ABCA4 protein.

In the absence of a functional ABCA4 protein, retinal accumulates within photoreceptor outer segments where it generates membrane-damaging reactive oxygen species, and also spontaneously reacts with cellular lipids and other retinaldehyde molecules. These retinal-retinal species, known as bisretinoids, and oxidized membranes are taken into the RPE through normal diurnal phagocytic processing where they gradually accumulate. It is theorized that these compounds reach a critical mass within RPE phagolysosomes and cause dysfunction of the metabolic activities of the RPE leading to early accelerated accumulation of lipofuscin which severely compromises the ability of the RPE to nourish the retina.

## Symptoms of STGD1

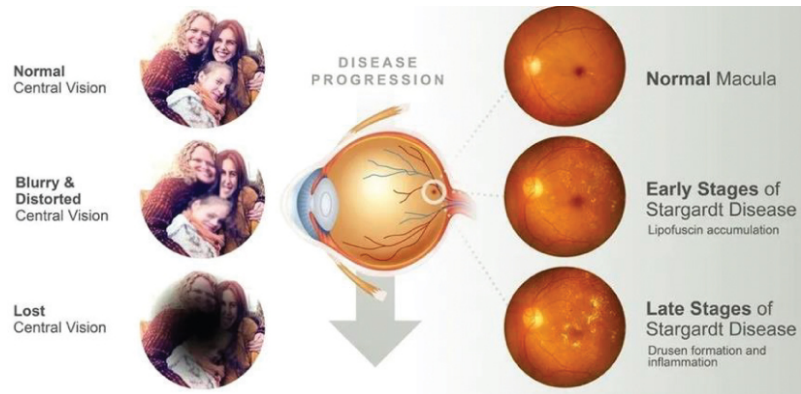

Source: <https://makariwellness.com/stargardt-disease/>

**Preclinical Proof of Concept***Abca4<sup>-/-</sup> / Rdh8<sup>-/-</sup> STGD1 mouse model*

In the *Abca4<sup>-/-</sup> / Rdh8<sup>-/-</sup>* double knockout STGD1 mouse model, daily dosing at approximately 25 mg/kg of LBS-008 was given for 12 weeks. A mean RBP4 reduction of approximately 90% in LBS-008 treated double knockout mice was achieved and led to an approximately 80% reduction of A2E, that are known to cause STGD1 and have been implicated in progression of dry AMD, compared to the untreated double knockout mice.

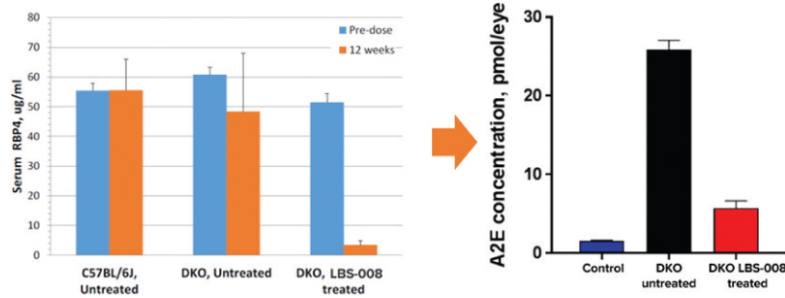

Importantly, Outer Nuclear Layer, or ONL, thickness was significantly decreased in untreated *ABCA4<sup>-/-</sup>/RDH8<sup>-/-</sup>* mice, compared to the double knockout mice treated with LBS-008. Macular degeneration in Dry AMD and STGD1 is associated with thinning of the ONL which indicates loss of photoreceptor cells, which is believed to be caused by excessive levels of bisretinoid toxins.

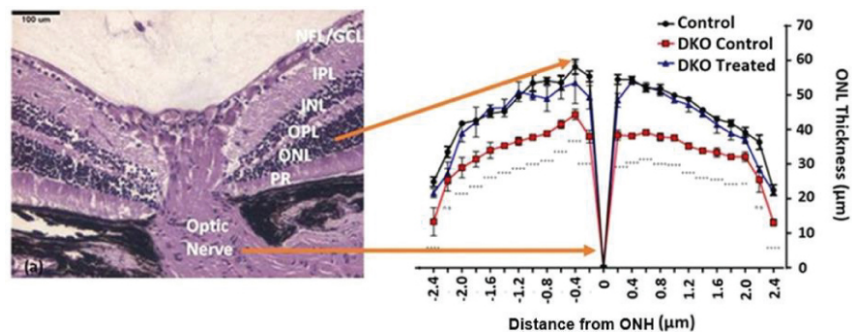

### *Clinical Development*

As of the date of this prospectus, we have initiated our Phase 3 clinical trial in adolescent STGD1 patients, and received approval to commence patient enrollment in Taiwan, the U.K., Hong Kong and Switzerland. In addition, we are in the process of applying for the necessary approvals to conduct the same clinical trial in other relevant jurisdictions. We are also conducting our ongoing Phase 2 clinical trial of LBS-008 in adolescent STGD1 patients. Previously, we completed a Phase 1b clinical trial of LBS-008 in adolescent STGD1 patients in late-2021 and two Phase 1 clinical trials of LBS-008 in healthy adult subjects in mid-2020.

#### *Phase 3 Clinical Trial in STGD1*

As of the date of this prospectus, we have initiated a randomized, double-masked, placebo-controlled, global, multi-center Phase 3 clinical trial, to evaluate the safety and efficacy of LBS-008 in adolescent STGD1 patients and received approval to commence patient enrollment in Taiwan, the U.K., Hong Kong and Switzerland. In addition, we are in the process of applying for the necessary approvals to conduct the same clinical trial in other relevant jurisdictions. This study consists of a screening period, a treatment period of 2 years, and a follow-up period of one month. Approximately 60 patients are targeted for enrollment in this study with a 2:1 randomization (active:placebo). The Phase 3 clinical trial in STGD1 aims to evaluate the efficacy of LBS-008 by assessing any improvements or changes in visual function and morphological and biomarker changes as detected on specialized retinal imaging. Safety and tolerability will also be assessed during the clinical study period. This trial is expected to be conducted at multiple sites across Australia, Asia, Europe, and North America. See “Risk Factors — In the event that we elect to carry out clinical trials in China and/or expand our operations into China in the future, we will be subject to changing legal and regulatory requirements in the PRC pharmaceutical industry, and new laws, rules and regulations may adversely affect our profitability or impose additional compliance burdens on us.”

#### *Phase 1b/2 Clinical Trial in STGD1*

We initiated an open-label, dose-finding Phase 1b/2 clinical trial in adolescent STGD1 patients in mid-2020 in Australia and Taiwan. The study design includes two portions: Phase 1b and Phase 2. We have completed the Phase 1b portion of this study in 11 adolescent STGD1 patients which has extended into a two-year, Phase 2 study with 13 adolescent STGD1 patients in Australia and Taiwan. The expected enrollment of this study was 10 patients. As of the date of this prospectus, data is available for the 11 patients who have completed the Phase 1b portion and for all 13 patients who have received at least 6 months of treatment and completed the scheduled assessments at the first 6 month interval.

The Phase 1b portion is a dose-finding study designed to determine the optimal dose of LBS-008 and to evaluate safety, tolerability, PK and PD in adolescent STGD1 patients for a treatment period of 2 cycles of 14-day daily dosing of LBS-008 (28 days of daily treatment) and a 14-day follow-up period. The Phase 2 portion consists of a 2-year treatment period with a follow-up period of one month. In the Phase 2 portion of the study, in addition to monitoring the safety and tolerability, we aimed to monitor PK and PD



biomarkers (RBP4 and retinol) and the effects of treatment using various retinal imaging modalities (including DDAF, QDAF, SD-OCT, and microperimetry), change in BCVA, and the relationship between the change in RBP4 levels and rate of lesion growth. Furthermore, a Safety Review Committee, or SRC, and an independent Data and Safety Monitoring Board, or DSMB, were formed to monitor the Phase 1b portion of this study to evaluate all the safety, toxicity, and dose response data and provide recommendations for the appropriate dose to be used for Phase 2. The DSMB will continue to monitor the safety and efficacy trends throughout the Phase 2 study. Interim data read-outs will be captured at Months 12, 15, 18 and 21, and a final data read-out will be captured at Month 24.

#### Efficacy Results

For the Phase 1b portion, the PD profiles showed that the mean RBP4 level reached and maintained below 30% of the mean baseline value throughout the treatment period. Mean RBP4 level returned to close to baseline values following 14 days of drug cessation. LBS-008 plasma concentration and RBP4 suppression appeared to be correlated. Comparison of PD profiles observed in healthy adults and in adolescent STGD1 patients showed a similarity between the two populations.

Mean RBP4 level of Phase 1b

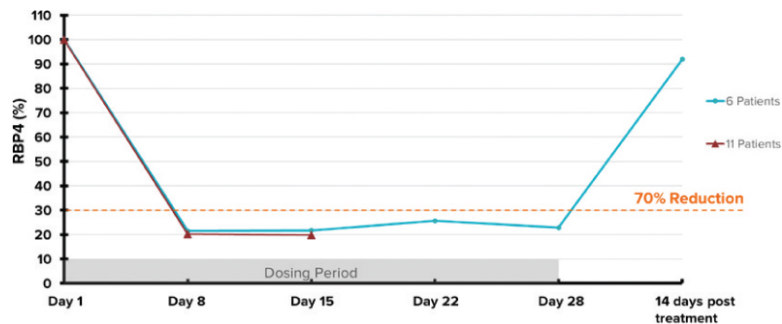

*Note: After Day 15, data were collected from 6 subjects in Australian sites only as data could not be collected due to COVID-19 restrictions at the NTUH site in Taiwan. Mean change of RBP4 (%) for all 11 patients for Days 1 to 15 is presented as the 11-Patients line, and data for the 6 patients in Australian sites for the whole Phase 1b portion is presented as the 6-Patients line.*

Upon completion of the Phase 1b portion, an optimal daily dose was identified and which was able to achieve a mean RBP4 reduction of > 70%, relative to baseline values.

We are currently conducting the Phase 2 portion of this study. A total of 13 adolescent STGD1 patients were enrolled in the Phase 2 portion of the Phase 1b/2 study. As of the date of this prospectus, all 13 patients have received at least 6 months of treatment and completed the scheduled assessments at the first 6 month interval. Change in BCVA (ETDRS letter score) and FAF imaging results at 6-months are compared to the baseline measurements at the start of Phase 2. The preliminary data shows that 8 of the 13 patients (or 61.5%) recorded a gain in BCVA (ETDRS letter score) in at least one eye, including 2 patients who recorded a gain in BCVA in both eyes. The average BCVA from the 13 patients was an average loss of 2.8 letters in the right eye, and an average gain of 1.9 letters in the left eye. On FAF retinal imaging, 8 of the 13 patients (or 61.5%) had a reduction or no change in their QDAF area size in at least one eye, including 5 patients who had a reduction or no change in QDAF area size in both eyes. There was an average gain in QDAF area in the right eye of  $0.2 \pm 0.09\text{mm}^2$  (Mean  $\pm$  SEM) and in the left eye of  $0.1 \pm 0.09\text{mm}^2$  (Mean  $\pm$  SEM). While 12 of the 13 patients had no DDAF lesion measured at the start of Phase 2 and at 6-months, 1 of the 13 patients had a DDAF lesion growth of  $0.3\text{mm}^2$  in both eyes during the 6-month period. On SD-OCT imaging, a gradual thinning with an average of approximately 7 to 10 microns (on total retinal thickness by ETDRS regions) was observed in both eyes. In the Ellipsoid Zone (EZ), an average increase in defect width of 0.26mm in the right eye and 0.61mm in the left eye were observed. However, 6 patients

had a reduction in EZ defect width in at least 1 eye (including 3 patients in both eyes). Additional interim data read-outs will be captured at Months 12, 15, 18 and 21, and a final data read-out will be captured at Month 24.

#### *Phase 1b Safety Results*

The preliminary safety results of the Phase 1b study shows that the only drug-related adverse events reported were DDA (i.e., a delay in the time required to adjust to a dimly lit environment), and xanthopsia/chromatopsia (i.e., a transient color tint in the field of vision), both reported by 7 of the 11 patients (or 63.6%), and night vision impairment, reported by 1 of 11 patient (or 9.1%), and were all graded as mild. All of these adverse events were resolved with the cessation of treatment at the end of the Phase 1b study.

Reports of transient DDA, night vision impairment, and xanthopsia/chromatopsia were anticipated and are consistent with the mechanism of LBS-008 action. It is notable that the majority of DDA cases required confirmation by laboratory measure (dark adaptometry) as many subjects were asymptomatic. No deaths nor serious or severe adverse events were reported. In addition, there were no clinically significant findings related to vital signs, physical exams, or ECGs.

Adverse Events	Severity	Relationship to Drug	Frequency (#Patients)	% Recovered	% On-going
Xanthopsia/Chromatopsia	Mild	Definitely Related	7/11	7/7 (100%)	0/7
Delayed Dark Adaptation (DDA)	Mild	Definitely Related	7/11	7/7 (100%)	0/7
Night Vision Impairment	Mild	Definitely Related	1/11	1/1 (100%)	0/1

#### *Phase 2 Safety Results*

The preliminary safety results of the Phase 2 study shows that the only definitely and probably drug-related adverse events reported were DDA, reported by 8 of 13 patients (or 61.5%), xanthopsia/chromatopsia, reported by 6 of 13 patients (or 46.2%), night vision impairment, reported by 1 of 13 patients (or 7.7%), and increasing error score on FM100 test (a test of color vision and color perception), reported by 1 of 13 patients (or 7.7%), and were all graded as mild. No deaths nor serious or severe adverse events were reported. In addition, there were no clinically significant findings related to vital signs, physical exams, or ECGs.

Adverse Events	Severity	Relationship to Drug	Frequency (#Patients)	% Recovered	% On-going
Xanthopsia/Chromatopsia	Mild	Definitely Related	6/13	3/6 (50%)	3/6 (50%)
Delayed Dark Adaptation (DDA)	Mild	Definitely Related	8/13	1/8 (12.5%)	7/8 (87.5%)
Night Vision Impairment	Mild	Definitely Related	1/13	0/1	1/1 (100%)
Increasing error score on FM100	Mild	Probably Related	1/13	0/1	1/1 (100%)

#### *Dry AMD*

##### *Background*

Age-related macular degeneration, or AMD, is a common eye disorder among people over 50. It causes blurred or reduced central vision, due to thinning of the macula. The macula is the part of the retina responsible for clear vision in your direct line of sight.

##### **Symptoms of Dry AMD**





Source: <https://www.ncbi.nlm.nih.gov/pmc/articles/PMC6111111/>

Based on the classification system established in the AREDS, AMD has four stages, all of which may occur in one or both eyes:

- Category 1 is designated as “No AMD,” although there may be a few small (<63µm in diameter) yellowish subretinal deposits (i.e., drusen beneath the retina).
- Category 2 is designated as “Early AMD” and is characterized by multiple small drusen (<20µm in diameter), a few intermediate drusen (63-124µm in diameter), and abnormalities of the RPE, a monolayer of epithelial cells that lies beneath the retina and provides trophic and metabolic support to photoreceptor cells of the retina.
- Category 3 is designated as “Intermediate AMD,” where there is extensive intermediate drusen, large drusen (>125µm in diameter), or GA (i.e., localized atrophy of the retina) and increased lipofuscin in the RPE.
- Category 4 is designated as “Advanced AMD” and is characterized by GA or neovascular maculopathy (i.e., ‘wet’ AMD).

The only approved therapies for AMD are for ‘wet’ AMD, which represents approximately 10% of all AMD cases. There are no approved therapies for the other stages of AMD, which are collectively referred to as dry AMD and represents approximately 90% of all AMD cases.

### ***Clinical Development***

#### ***Phase 2 or Phase 3 Clinical Trials in Dry AMD***

We are currently evaluating our plan to initiate, in 2022, a randomized, double-masked, placebo-controlled, global, multi-center Phase 2 or Phase 3 trial to evaluate the safety and efficacy of LBS-008 in the treatment of dry AMD, which is expected to be conducted at multiple sites across the United States, Europe and Asia Pacific. See “Risk Factors — In the event that we elect to carry out clinical trials in China and/or expand our operations into China in the future, we will be subject to changing legal and regulatory requirements in the PRC pharmaceutical industry, and new laws, rules and regulations may adversely affect our profitability or impose additional compliance burdens on us.” Such trials would aim to evaluate the efficacy of LBS-008 by assessing any improvements or changes in visual function and morphological and biomarker changes as detected on specialized retinal imaging. Safety and tolerability will also be assessed during the clinical study period.

Patients are expected to be randomized to two treatment cohorts to receive a once-daily oral dose of LBS-008 or placebo.

#### ***Clinical Trials in Healthy Adult Subjects***

##### ***Phase 1 Clinical Trials in Healthy Adult Subjects (Single and Multiple Ascending Dose Studies in Australia)***

We have completed randomized, double-blind, placebo-controlled, single and multiple ascending dose Phase 1 trials of LBS-008 in 71 healthy adult subjects in July 2020 in Australia. 39 (including 10 placebo) and 32 (including 8 placebo) healthy adult subjects were enrolled in single ascending dose and multiple ascending dose, respectively. Sample sizes were selected based on clinical and practical considerations.

Our primary outcome was to evaluate the safety and toxicity (drug-related adverse events and their severity/frequency), PK, and PD biomarkers (RBP4 and retinol) on a range of single ascending dose levels (from 25-400 mg) and multiple ascending dose levels (from 5-25 mg) of LBS-008 in healthy adult subjects in fasted conditions.

Furthermore, a SRC was formed to monitor and evaluate the safety data for the Phase 1 SAD and MAD studies.

### Efficacy Results

In the SAD study, we found that single doses of 25 – 400 mg LBS-008 were well tolerated and reduced mean RBP4 level by > 70% from baseline. A direct correlation between the LBS-008 plasma concentration and RBP4 suppression was observed.

Similar results were observed at steady-state in the MAD portion of the study. We found that all dose levels were well tolerated and have identified an optimal daily dose to reduce serum RBP4 by > 70% from baseline.

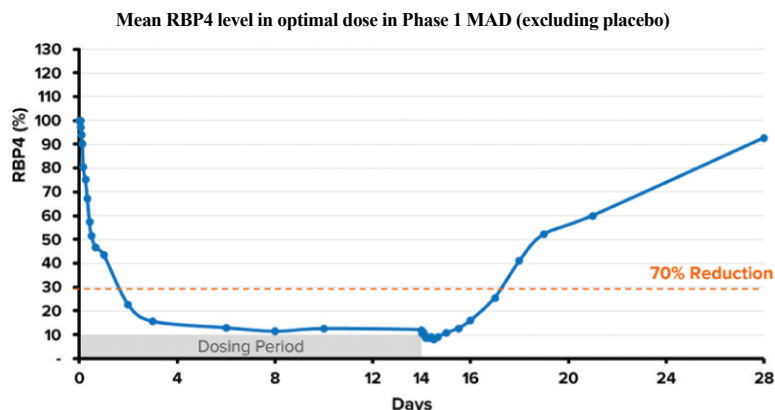

### Safety Results

All single ascending dose levels were well tolerated, including single ascending dose levels up to 400mg. One subject in the 100 mg cohort experienced a drug-related adverse event of mild transient xanthopsia. That event was resolved within 48 hours.

#### Drug-related adverse events in the SAD portion of the study

Adverse Events	Severity	Frequency (#Subjects)
Xanthopsia – yellow being more prominent in their color vision	Mild	1/29

All multiple ascending dose levels were also well tolerated. Most drug-related adverse events reported were mild in severity, and the most frequently reported drug-related adverse event was asymptomatic DDA, which did not show dose proportionality and reflects a reduction in vitamin A levels in the eye, which is the intended effect of LBS-008. No deaths, serious or severe adverse events were reported. The SRC approved dose escalations after reviewing the safety data profile at each dose level.

#### Drug-related adverse events in the MAD portion of the study

Adverse Events	Severity	Frequency (#Subjects)
Delayed Dark Adaptation (DDA)	Mild	16/24
Xanthopsia – yellow being more prominent in their colour vision	Mild	1/24
Photophobia – sensitivity to light	Mild	1/24
Ocular migraine	Mild	1/24
Intermittent dyspepsia (indigestion)	Mild	1/24
Migraine	Moderate	1/24

*Phase 1 Clinical Trial in Healthy Adult Subjects (Single Ascending Dose Study in the United States)*

We have completed a randomized, double-blind, placebo-controlled, single ascending dose Phase 1 trial of LBS-008 in 40 (including 10 placebo) healthy adult subjects in May 2020 in the United States. Our primary outcome was to evaluate the safety and toxicity (drug-related adverse events and their severity/frequency), PK, and PD biomarkers (RBP4 and retinol) on a range of single ascending dose levels, ranging from 10-50 mg, of LBS-008 in healthy adult subjects in fasted and fed conditions.

*Efficacy Results*

We found that single doses of 10–50 mg LBS-008 were well tolerated and reduced mean serum RBP4 level by around 70% from baseline. Following administration of a single oral dose of LBS-008, RBP4 level reached a minimum within 24-48 hours post-dose. Thereafter, RBP4 levels increased, returning to baseline levels generally by Day 12 post-dose compared with placebo subjects. The degree of lowering of RBP4 plasma concentrations increased with increasing LBS-008 dose. This study also compared doses of LBS-008 taken with and without food, which did not show a food effect with dosing.

*Safety Results*

All dose levels in this single ascending study were well tolerated. There were no reported drug-related adverse events in this Phase 1 study.

**LBS-009 for NAFLD/NASH and T2D**

LBS-009 is an anti-RBP4 oral therapy targeting liver disease, including NAFLD, NASH and T2D.

Currently, many compounds under investigation are focused on pathways associated with metabolism, inflammation, and fibrosis but they have demonstrated varied levels of efficacy often with conflicting results. NAFLD and NASH are a growing unmet need for which no FDA-approved treatments are currently available.

RBP4 is secreted by the liver and adipose tissue and has recently been identified as a pro-inflammatory cytokine in preclinical models of insulin resistance and liver disease. Therefore, RBP4 is currently being investigated as a clinical biomarker for human metabolic diseases. Clinical studies have found a significant association between elevated RBP4 levels in the circulation, impaired glucose tolerance, and NAFLD. Transgenic mice overexpressing RBP4 had a higher incidence of insulin resistance, a comorbid condition for NAFLD and NASH, and preclinical reports demonstrate that modulating RBP4 levels in the circulation will improve insulin resistance and reduce liver fat accumulation. LBS-009 is a small molecule designed to compete with retinol for binding to RBP4. When bound to LBS-009, RBP4 can no longer form a large molecular weight complex with transthyretin. Consequently, the RBP4/LBS-009 complex will be removed from circulation by renal filtration.

Preliminary PD studies with LBS-009 demonstrated the ability to reduce RBP4 levels in healthy rats by 85% following a single dose. Efficacy studies have been conducted in the ob/ob high-fat diet induced mouse model of metabolic disease. Treatment with LBS-009 significantly reduced RBP4 concentrations both in circulation and in adipose tissue, or fat tissue, resulting in improved insulin activity and glucose tolerance. Mice in these studies were dosed daily with LBS-009 for up to 16 weeks without any observed adverse effects. We believe that by therapeutically antagonizing RBP4 and reducing its concentration in the blood, we can mitigate local concentration of RBP4 in adipose tissue and reduce inflammation, thereby improving the metabolic phenotype. In preclinical studies, LBS-009 has shown the ability to ameliorate steatosis in transgenic mice, suggesting that antagonism of RBP4 with LBS-009 may serve as a potential pharmacotherapy for NASH.

**Research and Development Governance**

The research and development of drug products is a lengthy and expensive process. We have established research and development policies for all stages of our research and development activities, through our internal research project initiation processes and our preclinical and clinical development programs. Our research and development policies have enabled our senior management to continuously oversee and monitor

our Company's research and development activities for compliance with applicable laws, regulations, rules, guidelines and internal policies.

Our in-house discovery, research and development team focuses on identifying small-molecule compounds in our core therapeutic areas of macular degeneration and age-related metabolic diseases. The initiation of our research and development process begins with the identification and establishment of a research project. Upon conclusion of this initial process, an internal project report is produced by the research project team, which includes topics such as project background, significance, development history and research status, mechanism of action, pharmacokinetics, pharmacodynamics, clinical application, safety, drug interaction and market analysis, among other things.

We have relied on and plan to continue to rely on third-party CROs to monitor and manage data for some of our ongoing preclinical studies and clinical trials. We follow the highest industry standards to select the CROs that are going to conduct the services in order to meet FDA and other regulatory requirements.

#### **Manufacturing and Supply**

We currently rely on high-quality contract manufacturers to help produce preclinical and clinical supplies of our product candidate. Throughout our labs, we have assembled a seasoned internal team with deep experience in the field of chemistry to drive and help monitor our CMO processes and any external scale-up manufacturing. Our internal labs help monitor the manufacturing activities of research and development study material at our contract manufacturers to ensure compliance with local and international cGMP and applicable regulations.

#### **Intellectual Property**

Our commercial success depends in large part on our ability to obtain and maintain intellectual property and other proprietary protection for our product candidates, technologies, inventions, trade secrets and other know-how, as well as on our ability to defend and enforce our intellectual property or proprietary rights including any patent that we have or may issue from our owned, co-owned, or in-licensed patent applications, preserve the confidentiality of our trade secrets and operate without infringing, misappropriating or otherwise violating the valid and enforceable intellectual property and proprietary rights of other parties. We protect our proprietary and intellectual property position by, among other methods, licensing or filing in the United States and foreign jurisdictions, patent applications related to our proprietary technology, inventions and improvements that are important to the development and implementation of our business. We also seek to protect our trade secrets, know-how and continuing technological innovation through contractual obligations with third parties.

#### **Patents**

We have developed our lead product candidate, LBS-008, based on technology that we have exclusively licensed from the Trustees of Columbia University in the City of New York, or Columbia University, pursuant to a license agreement with Columbia University that was assigned to us from Lin Bioscience International Ltd., our principal shareholder. The license agreement has been amended five times, most recently as of February 4, 2022. As of December 31, 2021, the intellectual property in-licensed under our license agreement with Columbia University, including co-owned patents and patent applications, includes nine active patent families, which encompasses 18 issued U.S. patents and 4 pending U.S. patent applications, including original filings, continuations and divisional applications. The families also include numerous foreign counterparts, with claims granted or pending in Europe, China, Japan, South Korea, Australia and elsewhere. These licensed patent rights relate to methods of use, manufacture and compositions of matter and include issued patents with claims that recite a class of compounds directed to covering our lead compound, LBS-008, and specifically recite LBS-008. In terms of our key family of composition of matter patents, these include compounds of LBS-008 and LBS-009, and structurally similar derivatives, along with their methods of use in ophthalmic and metabolic indications. These issued patents covering LBS-008 and LBS-009 are expected to expire between 2034 and 2035, absent any patent term extensions.

In addition to the intellectual property licensed from Columbia University, as of December 31, 2021, we own and co-own five active patent families, which encompasses two issued U.S. patents and five pending U.S. patent applications, including provisional filings. These patent families also contain numerous foreign

counterparts, with claims granted or pending in Europe and elsewhere. These patent rights relate to methods of use, formulations, and companion diagnostics. Any patents issued from these patent applications are expected to expire between 2038 and 2042, absent any patent term adjustments or extensions.

*In-licensed Patents and Patent Applications*

Patent Family No.	Type of Patent	Issued Countries/ Regions and/or Application Type	Pending Countries/ Regions and/or Application Type	Termination Date (mm/dd/yyyy)	Subject to "March-in Rights" (Yes/ No)
1	Utility – Methods of Use	U.S Europe Japan	N.A	11/22/2031	Yes
2	Utility – Methods of Use	U.S	N.A	04/30/2033	Yes
3	Utility – Manufacture and Composition of Matter	U.S U.S Divisional #1 Europe Europe Divisional	U.S Divisional #2 Hong Kong	03/13/2034	Yes
4	Utility – Manufacture and Composition of Matter	U.S U.S Continuation #1 U.S Continuation #2 Europe	N.A	03/13/2034	Yes
5	Utility – Manufacture and Composition of Matter	U.S U.S Divisional	N.A	03/13/2034	Yes
6	Utility – Manufacture and Composition of Matter	U.S U.S Continuation	N.A	03/13/2034	Yes
7	Utility – Manufacture and Composition of Matter	U.S U.S Continuation #1 U.S Continuation #2 U.S Continuation #3 U.S Continuation #4 Europe Australia India Mexico Japan Philippines China Singapore Indonesia	U.S Continuation #5 Hong Kong South Korea Myanmar Thailand Canada China Divisional New Zealand Brazil	04/29/2035	Yes
8	Utility – Methods of Use	N.A	U.S Europe Hong Kong China	08/01/2039	Yes

*Co-owned Patents and Patent Applications*

Patent Family No.	Type of Patent	Issued Countries/ Regions and/or Application Type	Pending Countries/ Regions and/or Application Type	Termination Date (mm/dd/yyyy)	Subject to "March-in Rights" (Yes/ No)
9	Utility – Methods of Use	U.S., U.S. Divisional #1	U.S. Divisional #2 Europe Taiwan Hong Kong	06/14/2038	No

*Belite-owned Patents or Patent Applications*

Patent Family No.	Type of Patent	Issued Countries/ Regions and/or Application Type	Pending Countries/ Regions and/or Application Type	Expected Termination Date (mm/dd/yyyy)	Subject to "March-in Rights" (Yes/ No)
10	Utility – Methods of Use	N.A	U.S Europe Taiwan Hong Kong	06/14/2038	No
11	Utility – Formulations	N.A	U.S Europe Australia Canada China India Israel Japan South Korea Singapore Taiwan	07/06/2040	No
12	Utility – Companion Diagnostics	N.A	U.S Provisional	05/21/2042	No
13	Utility – Formulation	N.A	U.S Provisional	11/23/2042	No

The term of individual issued patents depends upon the legal term for patents in the countries in which they are obtained. In most countries in which we have filed, including the United States, the patent term is 20 years from the earliest filing date of a non-provisional patent application. The life of a patent, and the protection it affords, is therefore limited and once the patent life of our issued patents have expired, we may face competition, including from other competing technologies. The term of a patent that covers a drug or biological product may also be eligible for patent term extension when FDA approval is granted for a portion of the term effectively lost as a result of the FDA regulatory review period, subject to certain limitations and provided statutory and regulatory requirements are met. Any such patent term extension can be for no more than five years, only one patent per approved product can be extended, the extension cannot extend the total patent term beyond 14 years from approval, and only those claims covering the approved drug or biological product, a method for using it or a method for manufacturing it may be extended. We may not receive an extension if we fail to exercise due diligence during the testing phase or regulatory review process, fail to apply within applicable deadlines, fail to apply prior to expiration of relevant patents or otherwise fail to satisfy applicable requirements. Moreover, the length of the extension could be less than we request. In the future, we expect to apply for patent term extensions on certain issued patents covering our product candidates, depending upon the length of the clinical trials for each product candidate and other factors. There can be no assurance that we will benefit from any patent term extension or favorable adjustment to the term of any of our patents. As a result, our owned, co-owned and licensed patent portfolio may not provide us with sufficient rights to exclude others from commercializing products similar or identical to ours. For more information, see the section entitled "Risk Factors — Risks Related to Our Intellectual Property".

We granted rights to use our intellectual property to manage our clinical trials for STGD1 in Australia to our wholly-owned subsidiary, RBP4 Pty Ltd.

*Patent License Agreement with The Trustees of Columbia University in the City of New York*

In September 2016, Lin BioScience, Inc., our ultimate controlling shareholder, entered into an agreement with Columbia University (as amended, the “**Columbia License Agreement**”) for an exclusive worldwide license, under specified patent rights held by Columbia University, to develop and commercialize products covered by the licensed patent rights for all fields. The Columbia License Agreement was assigned to Lin Bioscience International Ltd. and subsequently assigned to us in 2018. We have the right to grant sublicenses under this license.

The patent rights licensed to us under the Columbia License Agreement include issued patents with claims that recite a class of compounds directed to covering our planned lead compound, LBS-008, and specifically recite LBS-008.

Under the Columbia License Agreement, we paid a one-time license fee of \$2.5 million in connection with the execution thereof. We will be obligated to make minimum annual royalty payments to Columbia University of (i) \$2.5 million on each of the second, third and fourth anniversaries of the first commercial sale of a licensed product and (ii) \$5 million on each anniversary of the first commercial sale of a licensed product, commencing on the fifth anniversary of such sale. We will also be obligated to pay single-digit earned royalties to Columbia University based on net sales of each licensed product by us and our affiliates and sublicensees. The minimum royalty payments will be creditable against the earned royalties accrued during the same calendar year. The license agreement obligates us to use commercially reasonable efforts to research, discover, develop and market licensed products for commercial sale and distribution and achieve certain development and regulatory approval milestones within certain timeframes, if certain milestones are achieved. We are also obligated to periodically inform Columbia University of our progress in meeting such milestones. The failure to achieve any such milestone would constitute a breach of the Columbia License Agreement. If we pay Columbia University the required fee, we will be granted a 6-month extension. As of the date of this prospectus, we have complied with the development and regulatory approval milestones under the Columbia License Agreement and requested no extensions. In the event that, after completion of Phase I Trials, there are unforeseen changes in clinical or regulatory development that we believe would affect the timely achievement of any milestone, we may request an extension from Columbia University for such milestone, which will not be unreasonably withheld or delayed. In the event that Columbia University does not agree to extend the deadlines to meet the milestones, and we are in breach for failure to timely meet the milestones or to make milestone or royalty payments, Columbia University may elect to convert our license to a nonexclusive license without the right to sublicense or initiate legal proceedings against third party patent infringers or terminate our license. We are also obligated to make payments to Columbia University in an aggregate amount of up to \$20 million based on achieving specified development and regulatory approval milestones and in an amount of up to \$25 million based on achieving a specified cumulative sales milestone with respect to the first licensed product. In addition, we are obligated to pay Columbia University a specified portion of revenue (other than royalties) we receive from sublicensees and a percentage of revenue in the low double-digits received from any sale of a priority review voucher by us or a sublicensee. In the event that we or a sublicensee do not sell a priority review voucher within one year of receipt, the earned royalties that we would be obligated to pay to Columbia University based on net sales of licensed products would increase by 1%. From inception through December 31, 2021, we have made a payment of \$1 million to Columbia University resulting from the Columbia License Agreement, which was triggered by the completion of our Phase 1 clinical trial. We believe we are in compliance with the terms of the license.

Our obligations under the Columbia License Agreement with respect to each licensed product in a particular country extends until the later of the expiration of the last-to-expire patent licensed from Columbia University covering the licensed product in such country, 20 years after the first commercial sale of the licensed product in such country or the expiration of any market exclusivity period granted by a regulatory agency. The last-to-expire patent licensed from Columbia University is anticipated to expire in 2039, absent any patent term adjustments or extensions.

Columbia University has the right to terminate the agreement if we breach the agreement and fail to cure our breach within specified cure periods or in the event of specified bankruptcy, insolvency and

liquidation events or if we initiate a proceeding challenging the validity or enforceability of any of the licensed patents. We have the right to terminate the agreement for our convenience at any time on 60 days' notice to Columbia University. In the event of termination, we have granted to Columbia University a royalty free, worldwide, non-exclusive license to make, use and sell products covered by claims of patents in-licensed by us, or derived from materials or technical information thereof, pursuant to the Columbia License Agreement and in connection with which we have filed patent applications or obtained patents.

#### ***Trade Secrets***

In addition to patents, we may rely, in some circumstances, upon unpatented trade secrets, know-how and continuing technological innovation to develop and maintain our competitive position. However, trade secrets and know-how can be difficult to protect. We seek to protect our proprietary information, in part, by executing confidentiality agreements with our scientific advisors, employees, consultants, collaborators, and other third parties, and invention assignment agreements with our consultants and employees.

#### ***Trademarks and domain names***

As of December 31, 2021, we had one registered trademark in the United States, one registered trademark in EU, two registered trademarks in China, one registered trademark in Hong Kong, and one registered trademark in Japan, and one trademark application pending in Canada. We did not have any trademark applications pending elsewhere around the world.

As of December 31, 2021, we have registered the following domain names: tinlarebant.com, tinlarebant.net, tinlarebant.org, belitebio.com, and belitebio.com.tw.

#### **Competition**

Our industry is highly competitive, rapidly evolving and subject to significant change. Although we believe that our core competencies in the identification, research and development of innovative therapies and our management team's regulatory and commercialization expertise provide us with distinct competitive advantages, we face significant competition from companies of all sizes around the world, including major and specialty pharmaceutical companies, generic drug companies, academic institutions, government agencies and research institutions.

Many of our competitors have significantly greater resources, including greater access to capital, technical capabilities and human resources, as well as more experience in the development and regulatory approval process than we have. Mergers and acquisitions in our industry may result in even more resources being concentrated among a smaller number of our competitors. Our commercial opportunities could be reduced or eliminated if our competitors develop or market novel therapies or other products that are more effective, safer or less costly than our current or future product candidates, or obtain regulatory approval for their products more rapidly than we may obtain approval for our product candidates.

With respect to macular degeneration therapies, although there are currently no approved treatments available, our competitors for LBS-008 include several companies going through clinical development for their product candidates. Based on publicly available information, we understand that there is one Japan-based pharmaceutical company that has an asset in Phase 3 development for STGD1. There are also three U.S.-based companies advancing treatments for STGD1 and their assets are currently in Phase 2 and Phase 2b development, respectively, with the third company having recently completed their Phase 2a trial. In GA, there are three U.S.-based companies in late-stage clinical development. All three companies have assets in Phase 3 development.

#### **Employees**

As of the date of this prospectus, we have twelve employees and four of our employees are located in the United States. The following table sets forth the number of our employees by function as of the date of this prospectus:

<b>Functions</b>	<b>Number of Employees</b>	<b>% of Total</b>
Finance and Accounting	5	42%
Research and Development	7	58%
<b>Total</b>	<b>12</b>	<b>100%</b>



We believe that we maintain a good working relationship with our employees, and we have not experienced any material labor disputes in the past. None of our employees are represented by labor unions.

**Facilities**

Our facilities consist of office and lab space of approximately 350 square feet in San Diego, California under a lease that will expire on July 19, 2022, office space of approximately 88 square feet in Taiwan under a lease that expires on July 31, 2022, and office and lab space of approximately 86 square feet in Shanghai, China under a lease that is automatically renewed every three months. We believe our current facilities are sufficient to meet our near-term needs, and we do not foresee any difficulty in extending the lease terms of our facilities upon their respective expiration dates.

**Legal Proceedings**

We are currently not involved in any legal or administrative proceedings that may have a material adverse impact on our business, financial position or results of operations.

## REGULATIONS

We are subject to a variety of U.S., European (including both laws applicable in the European Union and the U.K.) and PRC laws, rules and regulations across a number of aspects of our business. This section sets forth a summary of the most significant laws and regulations that are applicable to our current business activities within the territory of U.S., the European Union and PRC and that affect the dividends payment to our shareholders.

### **U.S. Regulation**

#### ***Government Regulation and Product Approval***

The U.S. Food and Drug Administration, or the FDA, and other regulatory authorities in the United States at federal, state and local levels extensively regulate, among other things, the research, development, testing, manufacture, quality control, import, export, safety, effectiveness, labeling, packaging, storage, distribution, recordkeeping, approval, advertising, promotion, marketing, post-approval monitoring and post-approval reporting of and for drug products. Along with third-party contractors, we are required to navigate the various preclinical, clinical and commercial approval requirements of the governing regulatory agencies of the countries in which we wish to conduct studies or seek approval or licensure of our product candidates. The processes for obtaining regulatory approvals in the United States and in foreign jurisdictions, along with subsequent compliance with applicable laws and regulations and other regulatory authorities, require the expenditure of substantial time and financial resources.

The failure to comply with applicable statutory and regulatory requirements may subject a sponsor, applicant or marketer to administrative or judicial enforcement actions. These actions could include the suspension or termination of clinical trials by the FDA, the FDA's refusal to approve pending applications or supplemental applications, withdrawal of an approval, "Warning Letters" (official messages from the FDA to a manufacturer or other organization providing notice that it has violated some rule in a federally regulated activity) or "Untitled Letters" (initial correspondences from the FDA that cite violations that do not meet the threshold of regulatory significance for a Warning Letter and request correction of the violation), product recalls, product seizures, total or partial suspension of production or distribution, import detention, injunctions, fines, refusals of government contracts, restitution, disgorgement of profits, or civil or criminal investigations and penalties brought by the FDA, the Department of Justice, or the DOJ, or other governmental entities.

#### ***Review and Approval for Licensing Drugs***

The FDA regulates drugs primarily under the Federal Food, Drug, and Cosmetic Act, or the FDCA, the Public Health Service Act, and their associated implementing regulations. Our product candidates must be approved by the FDA through the new drug application, or the NDA, process before they may be legally marketed in the United States. The process required by the FDA before a drug may be marketed in the United States generally involves the following:

- completion of extensive preclinical studies, including preclinical laboratory tests, preclinical animal studies and formulation studies all performed in compliance with applicable regulations, including the current good laboratory practice, or the cGLP, regulations;
- submission to the FDA of an investigational new drug application, or an IND, which must become effective before human clinical trials may begin and must be updated annually or when significant changes are made;
- manufacture, labeling and distribution of an investigational drug in compliance with current good manufacturing practices, or cGMP;
- approval by an institutional review board, or IRB, or ethics committee at each clinical site before each clinical trial may be initiated;
- performance of adequate and well-controlled human clinical trials in accordance with the FDA's current good clinical practices requirements, or cGCP, clinical trial registration, and other clinical trial

related regulations, to provide substantial evidence of effectiveness and evidence of safety for the drug product's proposed indication;

- preparation of and submission to the FDA of an NDA after completion of all pivotal clinical trials requesting marketing approval for one or more proposed indications;
- satisfactory completion of an FDA Advisory Committee review, where appropriate or if applicable, as may be requested by the FDA to assist with its review;
- satisfactory completion of one or more FDA pre-approval inspections of the manufacturing facility or facilities at which active pharmaceutical ingredient, or API, and finished drug product, or components thereof, are produced to assess compliance with cGMP and data integrity requirements to assure that the facilities, methods, and proposed chemistry, manufacturing, and controls, or CMC, are adequate to preserve the drug's identity, safety, quality, purity, potency and efficacy;
- satisfactory completion of FDA audits of selected preclinical and/or clinical investigation sites to assure compliance with cGLP and cGCP requirements and the integrity of the preclinical and/or clinical data;
- payment of user fees under the Prescription Drug User Fee Act, or, as amended, the PDUFA, for the relevant year;
- obtaining FDA review and approval of the NDA prior to any commercial marketing or sale of the drug in the United States; and
- compliance with all post-approval requirements, including but not limited to, cGMP, CMC, post-market reporting and pharmacovigilance, registration and listing, advertising and promotional requirements, the potential requirement to implement risk evaluation and mitigations strategies, or REMS, and the potential requirement to conduct post-approval studies.

In addition to drug-specific requirements, combinations of differently regulated articles, such as a drug and device (e.g., a drug delivery system or companion diagnostic) could also result in various additional requirements to consider, such as device and combination product requirements of the FDCA and its implementing regulations with respect to investigation, marketing, and post-market requirements.

Development of data and other information sufficient to support an NDA approval requires substantial time, effort and financial resources and we cannot be certain that any approvals for our product candidates will be granted on a timely basis, if at all. From time to time, new legislation is enacted that could significantly change the statutory provisions governing the testing, approval, manufacturing and marketing of products regulated by the FDA. In addition to new legislation, FDA regulations and policies are often revised or interpreted by the agency in ways that may significantly affect our business and our product candidates. It is impossible to predict whether further legislative changes will be enacted or whether FDA regulations, guidance, policies or interpretations will be changed or what the effect of such changes, if any, may be.

#### ***Preclinical Development***

The data required to support an NDA is generated in two distinct development stages: preclinical and clinical. For new chemical entities, or NCEs, the preclinical development stage generally involves synthesizing the active component, developing the formulation and determining the manufacturing process, evaluating purity and stability, as well as carrying out non-human toxicology, pharmacology and drug metabolism studies in the laboratory, which support subsequent clinical testing. The conduct of the preclinical studies must comply with federal regulations, including cGLPs. The sponsor must submit the results of the preclinical studies, together with manufacturing information, analytical data, any available clinical data or literature and a proposed clinical protocol, to the FDA as part of its IND. The central focus of an IND submission is on the general investigational plan and the protocol(s) for human studies. An IND is a request for authorization from the FDA to administer an investigational product to humans. The central focus of an IND submission is on the general investigational plan and the protocol(s) for human studies. An IND acts as an exemption from the FDCA that allows an unapproved drug to be shipped in interstate commerce for use in an investigational clinical trial. Such authorization must be secured prior to interstate shipment. Any subsequent protocol amendments must be submitted to the FDA as part of the IND, and the FDA must

allow these amendments to the IND to go into effect prior to their execution. Frequently, sponsors are also required to conduct additional animal studies after an IND is obtained and human clinical testing begins, and is often referred to as ‘preclinical’ or ‘nonclinical’ testing, even though it occurs in parallel with the clinical phase of development.

### ***Clinical Development***

Human clinical trials subject to the FDA’s jurisdiction may not begin until an IND is effective. The IND automatically becomes effective 30 days after receipt by the FDA, unless the FDA raises safety concerns or questions about the proposed clinical trial within the 30-day time period. In such a case, the IND may be placed on clinical hold and the IND sponsor and the FDA must resolve any outstanding concerns or questions before the clinical trial can begin. Submission of an IND therefore may or may not result in FDA authorization to begin a clinical trial.

The FDA may also place a clinical hold or partial clinical hold on such study following commencement of a clinical trial under an IND. A clinical hold is an order issued by the FDA to the sponsor to delay a proposed clinical investigation or to suspend an ongoing investigation. A partial clinical hold is a delay or suspension of only part of the clinical work requested under the IND. For example, a specific protocol or part of a protocol is not allowed to proceed, while other protocols may do so. No more than 30 days after the imposition of a clinical hold or partial clinical hold, the FDA will provide the sponsor with a written explanation of the basis for the hold. Following issuance of a clinical hold or partial clinical hold, an investigation may only resume after the FDA has notified the sponsor that the investigation may proceed. The FDA will base that determination on information provided by the sponsor correcting the deficiencies previously cited or otherwise satisfying the FDA that the investigation can proceed.

Clinical studies involve the administration of the investigational product to human subjects under the supervision of qualified investigators in accordance with cGCP regulations. Clinical studies are conducted under protocols detailing, among other things, the objectives of the study, the parameters to be used in monitoring safety and the effectiveness criteria to be evaluated. A separate submission to the existing IND must be made for each successive clinical trial conducted during product development and for any subsequent protocol amendments.

A sponsor may choose, but is not required, to conduct a foreign clinical trial under an IND. When a foreign clinical trial is conducted under an IND, all FDA IND requirements must be met unless waived. When the foreign clinical trial is not conducted under an IND, the sponsor must ensure that the study complies with cGCP regulations in order to use the study as support for an IND or application for marketing approval, including review and approval by an independent ethics committee and informed consent from subjects. Furthermore, an IRB for each site proposing to conduct the clinical trial must review and approve the plan for any clinical trial before the clinical trial begins at that site, and must monitor the study until completed. Some studies also include oversight by an independent group of qualified experts organized by the clinical trial sponsor, known as a data safety monitoring board, or the DSMB. DSMBs provide authorization for whether or not a study may move forward at designated check points based on access to certain data from the study and may halt the clinical trial if a DSMB determines that there is an unacceptable safety risk for subjects or based on other grounds, such as no demonstration of efficacy. Other grounds for suspension or termination may be made based on evolving business objectives and/or competitive climate. There are also requirements governing the reporting of ongoing clinical trials and clinical trial results to public registries.

In addition, if conducting a clinical study in a non-U.S. population, acceptance of clinical trial results by the FDA will depend, among other things, on whether the non-U.S. population that enrolled in the study is sufficiently similar to the indicated U.S. population that the results of the trial would fairly represent expected results in the U.S. population. The same issue can also arise in multi-national trials where non-U.S. sites are enrolling subjects that will become part of the data submitted to the FDA.

For purposes of drug approval, clinical trials are typically conducted in the following sequential phases that may overlap or be combined:

- Phase 1: The investigational product is initially introduced into a small number of healthy human subjects or patients with the target disease or condition. These studies are designed to test the safety,

dosage tolerance, absorption, metabolism and distribution of the investigational product in humans and the side effects associated with increasing doses. These studies may also yield early evidence of effectiveness.

- Phase 2: The investigational product is administered to a limited patient population with a specified disease or condition to evaluate the preliminary efficacy, optimal dosages and dosing schedule and to identify possible adverse side effects and safety risks.
- Phase 3: The investigational product is administered to an expanded patient population generally at multiple geographically dispersed clinical trial sites to further evaluate dosage, to provide statistically significant evidence of clinical efficacy and to further test for safety. These clinical trials are intended to generate sufficient data to statistically evaluate the efficacy and safety of the product for approval, to establish the overall risk/benefit ratio of the investigational product and to provide an adequate basis for product approval by the FDA and labeling of the drug product.

In some cases, the FDA may require, or companies may voluntarily pursue, additional clinical trials after a product is approved to gain more information about the product, sometimes referred to as “Phase 4” studies. Such post-approval studies, when applicable, are conducted following initial approval, typically to develop additional data and information relating to the biological characteristics of the product and the treatment of patients in the intended therapeutic indication.

Progress reports detailing the results of the clinical trials must be submitted at least annually to the FDA and more frequently if serious adverse events occur. In addition, IND safety reports must be submitted to the FDA for any of the following: suspected serious and unexpected adverse reactions; findings from epidemiological studies, pooled analysis of multiple studies, animal or in vitro testing, or other clinical trials, whether or not conducted under an IND, and whether or not conducted by the sponsor, that suggest a significant risk in humans exposed to the drug; and any clinically important increase in the rate of a serious suspected adverse reaction over such rate listed in the protocol or investigator brochure, which is a comprehensive document summarizing the body of information about an investigational product obtained during clinical and non-clinical trials.

Each of Phase 1, Phase 2 and Phase 3 clinical trials may not be completed successfully within any specified period, or at all. Furthermore, the FDA or the sponsor may suspend or terminate a clinical trial at any time on various grounds, including a finding that the research patients are being exposed to an unacceptable health risk. Similarly, an IRB can suspend or terminate approval of a clinical trial at its institution, or an institution it represents, if the clinical trial is not being conducted in accordance with such IRB’s requirements or if the drug has been associated with unexpected serious harm to patients. Additionally, if a clinical trial is overseen by a Data Safety Monitoring Board, or DSMB, the DSMB will provide authorization for whether or not a study may move forward at designated check points based on access to certain data from the study.

During clinical development, the sponsor often refines the indication and endpoints on which the drug will be based. For endpoints based on patient-reported outcomes, or PRO, and observer-reported outcomes, or ORO, the process typically is an iterative one. The FDA has issued guidance on the framework it uses to evaluate PRO instruments. Although the agency may offer advice on optimizing PRO and ORO instruments during the clinical development process, the FDA usually reserves final judgment until it reviews the drug.

Concurrent with clinical trials, companies must develop additional information about the chemistry and physical characteristics of the drug and finalize a process for manufacturing the product in commercial quantities in accordance with cGMP requirements. The manufacturing process must be capable of consistently producing quality batches of the product candidate, and cGMPs impose, among other things, extensive procedural, substantive and recordkeeping requirements to ensure and preserve the long-term stability and quality of the final drug product. Additionally, appropriate packaging must be selected and tested and stability studies must be conducted to demonstrate that the product candidate does not undergo unacceptable deterioration over its shelf life. Any changes to the drug product during development, and especially after Phase 2, can raise questions with respect to impact of changes on study results, and whether results may be extrapolated to support approval of a final finished dosage form for which approval is sought.

During the clinical development process, earlier phase drug results may be promising, but it cannot be assumed that subsequent phases of development will be successful. In fact, it is often the case that drugs with promising early phase data fail to ultimately show sufficient efficacy or safety to support approval in later phases of development.

#### ***NDA Submission and Review***

Following study completion, study results and data are analyzed to assess safety and efficacy. The results of preclinical studies and clinical trials are then submitted to the FDA as part of an NDA, along with proposed labeling for the drug, information about the manufacturing process and facilities that will be used to ensure drug quality, results of analytical testing conducted on the chemistry of the drug and other relevant information. The NDA is a request for approval to market the drug and must contain adequate evidence of safety and efficacy, which is demonstrated by extensive preclinical and clinical testing. Data may come from company-sponsored clinical trials intended to test the safety and efficacy of a use of a drug, or from a number of alternative sources, including studies initiated by investigators. To support marketing approval, the data submitted must be sufficient in quality and quantity to establish the safety and efficacy of the investigational drug product to the satisfaction of the FDA.

In addition, under the Pediatric Research Equity Act of 2003, as amended and reauthorized, certain NDAs or supplements thereto must contain data that is adequate to assess the safety and efficacy of the drug for the claimed indications in all relevant pediatric subpopulations and to support dosing and administration for each pediatric subpopulation for which the drug is safe and effective. The FDA may, on its own initiative or at the request of the applicant, grant deferrals for submission of some or all pediatric data until after approval of the product for use in adults, or full or partial waivers from the pediatric data requirements.

Under the PDUFA, each NDA must generally be accompanied by a significant application user fee. The FDA adjusts the PDUFA user fees on an annual basis. Fee waivers or reductions are available in certain circumstances, including a waiver of the application fee for the first application filed by a small business which has fewer than 500 employees; in assessing whether an application qualifies as a 'first application' and calculating the number of employees, affiliates of the small business making the NDA submission are considered. Additionally, no user fees are assessed on NDAs for products designated as orphan drugs, unless the product also includes a non-orphan indication.

The FDA reviews all NDAs submitted before it accepts them for filing and may request additional information rather than accepting an NDA for filing. The FDA conducts a preliminary review of an NDA within 60 days of receipt and informs the sponsor by the 74th day after the FDA's receipt of the submission to determine whether the application is sufficiently complete to permit substantive review. Once the submission is accepted for filing, the FDA begins an in-depth review of the NDA. Under the goals and policies agreed to by the FDA under PDUFA, the FDA has ten months from the filing date in which to complete its initial review of a standard NDA and respond to the applicant, and six months from the filing date for a "priority review" NDA. The FDA does not always meet its PDUFA goal dates for standard and priority review NDAs, and the review process is often significantly extended by FDA requests for additional information or clarification.

After the NDA submission is accepted for filing, the FDA reviews the NDA to determine, among other things, whether the proposed drug is safe and effective for its intended use, and whether the drug is being manufactured in accordance with cGMP to assure and preserve the drug's identity, strength, quality, purity and efficacy. The FDA may refer applications for novel drugs or product candidates that present difficult questions of safety or efficacy to an advisory committee. Typically, an advisory committee consists of a panel that includes clinicians and other experts who will review, evaluate and provide a recommendation as to whether the application should be approved and, if so, under what conditions. The FDA is not bound by the recommendations of an advisory committee, but it considers such recommendations carefully when making decisions and usually follows such recommendations. The FDA may re-analyze the clinical trial data, which could result in extensive discussions between the FDA and us during the review process.

Before approving an NDA, the FDA will also conduct a pre-approval inspection of the manufacturing facilities for the new drug to determine whether they comply with cGMPs. The FDA will not approve the

drug unless it determines that the manufacturing processes and facilities are in compliance with cGMP requirements and adequate to assure consistent production of the drug within required specifications. In addition, before approving an NDA, the FDA may also audit data from clinical trials to ensure compliance with cGCP requirements. After the FDA evaluates the application, manufacturing process and manufacturing facilities where the drug product and/or its API will be produced, it may issue an approval letter or a complete response letter. An approval letter authorizes commercial marketing of the drug with specific prescribing information for specific indications. A complete response letter indicates that the review cycle of the application is complete and the application is not ready for approval. A complete response letter usually describes all of the specific deficiencies in the NDA identified by the FDA. The complete response letter may require additional clinical data and/or an additional pivotal clinical trial(s), and/or other significant, expensive and time-consuming requirements related to preclinical studies or clinical trials or manufacturing. If a complete response letter is issued, the applicant may either resubmit the NDA, addressing all of the deficiencies identified in the letter, or withdraw the application. Even if such data and information is submitted, the FDA may ultimately decide that the NDA does not satisfy the criteria for approval. Data obtained from clinical trials are not always conclusive and the FDA may interpret data differently than we interpret the same data.

If a drug receives marketing approval, the approval may be limited to specific diseases and dosages or the indications for use may otherwise be limited. Further, the FDA may require that certain contraindications, warnings or precautions be included in the drug labeling or may condition the approval of the NDA on other changes to the proposed labeling, development of adequate controls and specifications, or a commitment to conduct post-market testing or clinical trials and surveillance to monitor the effects of approved drugs. For example, the FDA may require Phase 4 testing which involves clinical trials designed to further assess a drug's safety and effectiveness and may require testing and surveillance programs to monitor the safety of approved drugs that have been commercialized. The FDA may also place other conditions on approvals including the requirement for a REMS to ensure that the benefits of a drug or biological product outweigh its risks. If the FDA concludes a REMS is needed, the sponsor of the NDA must submit a proposed REMS and the FDA will not approve the NDA without a REMS that the agency has determined is acceptable. A REMS could include medication guides, physician communication plans or elements to assure safe use, such as restricted distribution methods, patient registries and other risk minimization tools. Any of these limitations on approval or marketing could restrict the commercial promotion, distribution, prescription or dispensing of a drug. Drug approvals may be withdrawn for non-compliance with regulatory standards or if problems occur following initial marketing.

#### *Section 505(b)(2) NDAs*

NDAs for most new drug products are based on two or more adequate and well-controlled clinical trials, which must provide substantial evidence of effectiveness for, and demonstrate safety of, the proposed new product for a given indication (though, in certain cases, an NDA might be based on a single adequate and well-controlled clinical trial plus confirmatory evidence). These applications are submitted under Section 505(b)(1) of the FDCA. The FDA is, however, authorized to approve an alternative type of NDA under Section 505(b)(2) of the FDCA. This type of application allows the applicant to rely, in part, on the FDA's previous findings of safety and efficacy for a similar product, or published literature. Specifically, Section 505(b)(2) applies to NDAs for a drug for which the investigations made to show whether or not the drug is safe for use and effective in use and relied upon by the applicant for approval of the application "were not conducted by or for the applicant and for which the applicant has not obtained a right of reference or use from the person by or for whom the investigations were conducted."

Section 505(b)(2) authorizes the FDA to approve an NDA based in part on prior FDA determinations as opposed to solely on safety and effectiveness data developed by the applicant. NDAs filed under Section 505(b)(2) may provide an alternate and potentially more expeditious pathway to FDA approval for new or improved formulations or new uses of previously approved products. If the 505(b)(2) applicant can establish that reliance on the FDA's previous approval is scientifically appropriate, the applicant may eliminate the need to conduct certain preclinical studies or clinical trials of the new product. However, the FDA may require applicants to perform additional studies or measurements to support the change(s) from the previously approved product. The FDA may then approve the new product candidate for all or some of

the label indications for which the referenced product has been approved, as well as for any new indication sought by the Section 505(b)(2) applicant.

#### *Pediatric Studies*

With the enactment of the Food and Drug Administration Safety and Innovation Act in 2012, a sponsor who is planning to submit a marketing application (or supplement to an application) for a drug that includes a new active ingredient, new indication, new dosage form, new dosing regimen or new route of administration must also submit an initial Pediatric Study Plan, or a PSP, within sixty days of an end-of-Phase 2 meeting or as may be agreed between the sponsor and the FDA, unless the drug is for an indication for which orphan designation has been granted. In the absence of an end-of-phase 2 meeting, the sponsor should submit the initial PSP as early as practicable but before the initiation of any phase 3 studies, or any combined phase 2 and phase 3 studies, of the drug that is the subject of the initial PSP. The initial PSP must include an outline of the pediatric study or studies that the sponsor plans to conduct, including study objectives and design, age groups, relevant endpoints and statistical approach, or a justification for not including such detailed information, and any request for a deferral of pediatric assessments or a full or partial waiver of the requirement to provide data from pediatric studies along with supporting information. The FDA and the sponsor must reach agreement on the PSP. A sponsor can submit amendments to an agreed-upon initial PSP at any time if changes to the pediatric plan need to be considered based on data collected from preclinical studies, early phase clinical trials and/or other clinical development programs.

#### *Orphan Drug Designation and Exclusivity*

Under the Orphan Drug Act, the FDA may designate a drug product as an “orphan drug” if it is intended to treat a rare disease or condition (generally meaning that it affects fewer than 200,000 individuals in the United States, or more in cases in which there is no reasonable expectation that the cost of developing and making a drug product available in the United States for treatment of the disease or condition will be recovered from sales of the product). A company must request orphan product designation before submitting a NDA. If the request is granted, the FDA will publicly disclose the identity of the therapeutic agent and its potential use. Orphan product designation does not convey any advantage in or shorten the duration of the regulatory review and approval process, but the product will be entitled to orphan product exclusivity, meaning that the FDA may not approve any other applications for the same product for the same indication for seven years, except in certain limited circumstances. Those circumstances include instances in which another sponsor’s application for the same drug product and indication is shown to be “clinically superior” to the previously approved drug. In this context, clinically superior means that the drug provides a significant therapeutic advantage over and above the already approved drug in terms of greater efficacy, greater safety or by providing a major contribution to patient care. Competitors may receive approval of different products for the indication for which the orphan product has exclusivity and may obtain approval for the same product but for a different indication. If a drug or drug product designated as an orphan product ultimately receives marketing approval for an indication broader than what was designated in its orphan product application, it may not be entitled to exclusivity.

#### *Rare Pediatric Disease Designation and Priority Review Vouchers*

Under the FDCA, the FDA incentivizes the development of drugs that meet the definition of a “rare pediatric disease,” defined to mean a serious or life-threatening disease in which the serious or life-threatening manifestations primarily affect individuals aged from birth to 18 years and the disease affects fewer than 200,000 individuals in the United States or affects more than 200,000 in the United States and for which there is no reasonable expectation that the cost of developing and making in the United States a drug for such disease or condition will be recovered from sales in the United States of such drug. The sponsor of a product candidate for a rare pediatric disease may be eligible for a voucher that can be used to obtain a priority review for a subsequent human drug application after the date of approval of the rare pediatric disease drug product, referred to as a priority review voucher, or PRV. A sponsor may request rare pediatric disease designation from the FDA prior to the submission of its NDA. A rare pediatric disease designation does not guarantee that a sponsor will receive a PRV upon approval of its NDA. Moreover, a sponsor who chooses not to submit a rare pediatric disease designation request may nonetheless receive a PRV upon approval of their marketing application if they request such a voucher in their original marketing



application and meet all of the eligibility criteria. If a PRV is received, it may be sold or transferred an unlimited number of times. Also, the FDA may revoke any rare pediatric disease priority review voucher if the rare pediatric disease product for which the voucher was awarded is not marketed in the United States within the 365-day period beginning on the date of the approval. Congress has extended the PRV program through September 30, 2026, with the potential for PRVs to be granted through September 30, 2026.

#### ***Post-Approval Requirements***

Any products manufactured or distributed pursuant to FDA approvals are subject to pervasive and continuing regulation by the FDA, including, among other things, requirements relating to monitoring, recordkeeping, registration and listing, periodic reporting, reporting of certain deviations and adverse experiences, providing the regulatory authorities with updated safety and efficacy information, drug sampling and distribution requirements, and complying with applicable promotion and advertising requirements. After approval, most changes to the approved product, such as adding new indications or other labeling claims, are subject to FDA review and approval. There also are continuing user fee requirements, under which the FDA assesses an annual program fee for each product identified in an approved NDA.

FDA regulations also require that approved products be manufactured in specific approved facilities and in accordance with cGMP. We currently use contract manufacturing organizations, or CMOs, to manufacture the drugs used in our clinical trials and expect to rely on third parties for the production of commercial quantities of our products in accordance with cGMP regulations. NDA holders using CMOs, laboratories or packagers are responsible for the selection and monitoring of qualified firms, and, in certain circumstances, qualified suppliers to these firms. These manufacturers must comply with cGMP regulations that require, among other things, quality control and quality assurance as well as the corresponding maintenance of records and documentation and the obligation to investigate and correct any deviations from cGMP. Drug manufacturers and their third-party contractors are required to register their establishments with the FDA and certain state agencies. These establishments are subject to routine and periodic unannounced inspections by the FDA and certain state agencies for compliance with cGMP and data integrity requirements, which impose certain procedural and documentation requirements to assure quality of manufacturing and product. Any interference with FDA inspection activities at our company or at CMOs can result in substantial penalties. The FDA has increasingly observed cGMP violations involving data integrity during site inspections and investigating compliance with data integrity requirements is a significant focus of its oversight. Requirements with respect to data integrity include, among other things, controls to ensure data are complete and secure; requiring that activities are documented at the time of performance; audit trail functionality; requiring authorized access and limitations; validated computer systems; and the review of records for accuracy, completeness and compliance with established standards.

Post-approval changes to the manufacturing process, including changes of the site of manufacture, are strictly regulated, and, depending on the significance of the change, may require FDA approval before being implemented. FDA regulations also require investigation and correction of any deviations from cGMP and impose reporting requirements upon us and any third-party CMOs that we may decide to use. Accordingly, manufacturers must continue to expend time, money and effort in the area of production and quality control to maintain compliance with cGMP, data integrity, pharmacovigilance (*i.e.*, post-marketing safety reporting obligations) and other aspects of regulatory compliance.

The FDA may withdraw a product approval if compliance with regulatory requirements and standards is not maintained or if problems occur after the product reaches the market. Later discovery of previously unknown problems with a product, including adverse events of unanticipated severity or frequency, or with manufacturing processes, or failure to comply with regulatory requirements, may result in revisions to the approved labeling to add new safety information; imposition of post-approval studies or clinical trials to assess new safety risks; or imposition of distribution or other restrictions under a REMS. Other potential consequences include:

- restrictions on the marketing or manufacturing of a product, complete withdrawal of the product from the market or product recalls;
- fines, Warning Letters, Untitled Letters or holds on post-approval clinical trials;

- refusal of the FDA to approve pending applications or supplements to approved applications, or suspension or revocation of existing product approvals;
- product seizure or detention, or refusal of the FDA to permit the import or export of products that it believes present safety problems by issuing an Import Alert;
- permanent injunctions and consent decrees, including the imposition of civil or criminal penalties;
- adverse publicity;
- voluntary or mandatory product recall; and
- recoupment of payment and damages for noncompliant drug products based on various legal theories, including a theory that reimbursement for noncompliant products violates federal and state false claims laws (e.g., the federal False Claims Act).

The FDA strictly regulates the marketing, labeling, advertising and promotion of prescription drug products placed on the market. A company can make only those claims relating to safety and efficacy, identity, strength, quality, purity and potency that are approved by the FDA and in accordance with the provisions of the approved label. Promotional claims relating to a product's safety or effectiveness are prohibited before the drug is approved. After approval, a product generally may not be promoted for uses that are not approved by the FDA, as reflected in the product's prescribing information. In the United States, healthcare professionals are generally permitted to prescribe drugs for such uses not described in the drug's labeling, known as off-label uses, because the FDA does not regulate the practice of medicine. However, FDA regulations impose rigorous restrictions on manufacturers' communications, prohibiting the promotion of off-label uses. It may be permissible, under very specific, narrow conditions, for a manufacturer to engage in non-promotional, non-misleading communication regarding off-label information, such as distributing scientific or medical journal information in accordance with the FDA's good reprint practices or unsolicited request doctrine.

If a company is found to have promoted off-label uses, it may become subject to adverse public relations and administrative and judicial enforcement by the FDA, the DOJ or the Office of the Inspector General of the Department of Health and Human Services, as well as other federal and state authorities. This could subject a company to a range of penalties that could have a significant commercial impact, including civil and criminal fines and agreements that materially restrict the manner in which a company promotes or distributes products. The federal government has levied large civil and criminal fines against companies for alleged improper promotion, and has also requested that such companies enter into consent decrees and permanent injunctions under which specified promotional conduct is changed or curtailed. Among other legal theories, penalties may be sought based on a theory that off-label promotion causes submission of claims that for an unapproved use in violation of state and federal false claims laws.

#### ***Other Regulatory Matters***

Manufacturing, sales, promotion and other activities following drug approval are also subject to regulation by numerous regulatory authorities in addition to the FDA, including, in the United States, the Centers for Medicare & Medicaid Services, other divisions of the Department of Health and Human Services, the Drug Enforcement Administration for controlled substances, the Consumer Product Safety Commission, the Federal Trade Commission, the Occupational Safety & Health Administration, the Environmental Protection Agency and state and local governments. The activities of pharmaceutical manufacturers are subject to federal and state laws designed to prevent "fraud and abuse" in the healthcare industry. The laws generally limit financial interactions between manufacturers and health care providers or other participants in the healthcare industry, require disclosure to the government and public of such interactions, and govern various matters regarding reimbursement of healthcare products. Many of these laws and regulations contain ambiguous requirements or require administrative guidance for implementation. Pharmaceutical manufacturers are also required to provide discounts or rebates under government healthcare programs or to certain government and private purchasers in order to obtain coverage under federal healthcare programs such as Medicaid. Participation in such programs may require tracking and reporting of certain drug prices. Manufacturers are subject to fines and other penalties if such prices are not reported accurately. Additionally, the handling of any controlled substances must comply with the U.S. Controlled Substances

Act and Controlled Substances Import and Export Act. Drugs must meet applicable child-resistant packaging requirements under the U.S. Poison Prevention Packaging Act. Manufacturing, sales, promotion and other activities are also potentially subject to federal and state consumer protection and unfair competition laws.

The distribution of prescription drugs and biologics are subject to the Drug Supply Chain Security Act, which requires manufacturers and other stakeholders to comply with product identification, tracing, verification, detection and response, notification and licensing requirements. In addition, the Prescription Drug Marketing Act and its implementing regulations and state laws limit the distribution of prescription pharmaceutical product samples, and the Drug Supply Chain Security Act imposes requirements to ensure accountability in distribution and to identify and remove prescription drug and biological products that may be counterfeit, stolen, contaminated, or otherwise harmful from the market.

#### *Hatch-Waxman Protections and Pediatric Exclusivity*

##### *Patent Term Restoration*

After approval, owners of relevant drug or biological product patents may apply for up to a five-year patent extension to restore a portion of patent term lost during product development and FDA review of an NDA if approval of the application is the first permitted commercial marketing or use of a drug containing the API under the Hatch-Waxman Act. The allowable patent term extension is calculated as one-half of the product's testing phase, which is the time between IND and NDA submission, and all of the review phase, which is the time between NDA submission and approval, up to a maximum of five years. The time can be shortened if the FDA determines that the applicant did not pursue approval with due diligence. The total patent term after the extension may not exceed more than 14 years from the date of FDA approval of the product. Only one patent claiming each approved product is eligible for restoration and the patent holder must apply for restoration within 60 days of approval. The USPTO, in consultation with the FDA, reviews and approves the application for patent term restoration.

For patents that might expire during the application phase, the patent owner may request an interim patent extension. An interim patent extension increases the patent term by one year and may be renewed up to four times. For each interim patent extension granted, the post-approval patent extension is reduced by one year. The director of the USPTO must determine that approval of the product candidate covered by the patent for which a patent extension is being sought is likely. Interim patent extensions are not available for a product candidate for which an NDA has not been submitted.

##### *Patent Listing and the Orange Book*

In seeking approval for a drug through an NDA, applicants are required to list with the FDA each drug substance, drug product, and method-of-use patent whose claims cover the NDA drug product. Upon approval of the NDA, each of the patents listed in the application for the drug is published in the FDA's Approved Drug Products with Therapeutic Equivalence Evaluations, commonly known as the Orange Book. Drugs listed in the Orange Book can, in turn, be cited by potential competitors as reference listed drugs, or RLD, in support of approval of an abbreviated new drug application, or ANDA, or 505(b)(2) NDA which relies upon the RLD's approval to support its own.

An ANDA provides for marketing of a drug product that has the same active ingredients in the same strengths and dosage form as the listed drug and has been shown through bioequivalence testing to be therapeutically equivalent to the listed drug. Other than the requirement for bioequivalence testing, ANDA applicants are not required to conduct, or submit results of, nonclinical or clinical tests (beyond, potentially, bioequivalence studies) to prove the safety or effectiveness of their drug product. Drugs approved in this way are commonly referred to as "generic equivalents" to the listed drug, and can often be substituted by pharmacists under prescriptions written for the original listed drug under various state laws. A 505(b)(2) NDA is generally used where there are one more difference from the RLD in terms of dosage form, labeling, or other properties, but where an applicant may nonetheless rely upon FDA's prior approval determinations with respect to the RLD to support safety and/or efficacy of the 505(b)(2) NDA drug product.

An ANDA or 505(b)(2) NDA applicant is required to certify to the FDA concerning any patents listed for the RLD in the FDA's Orange Book. Specifically, the applicant must certify that: (i) the required patent information has not been filed; (ii) the listed patent has expired; (iii) the listed patent has not expired, but will expire on a particular date and approval is sought after patent expiration; or (iv) the listed patent is invalid or will not be infringed by the new product. An ANDA applicant may also elect to submit a section viii statement, certifying that its proposed ANDA label does not contain or carve out any language regarding the patented method-of-use, rather than certify to a listed method-of-use patent.

If the applicant does not challenge the listed patents, the ANDA or 505(b)(2) NDA will not be approved until all the listed patents claiming the referenced product have expired. A certification that the new product will not infringe the already approved product's listed patents, or that such patents are invalid, is called a Paragraph IV certification. If the ANDA or 505(b)(2) NDA applicant has provided a Paragraph IV certification to the FDA, the applicant must also send notice of the Paragraph IV certification to the NDA and patent holders once the ANDA or 505(b)(2) NDA has been accepted for filing by the FDA. The NDA and patent holders may then initiate a patent infringement lawsuit in response to the notice of the Paragraph IV certification. The filing of a patent infringement lawsuit within 45 days of the receipt of a Paragraph IV certification automatically prevents the FDA from approving the ANDA or 505(b)(2) NDA until the earlier of 30 months, expiration of the patent, settlement of the lawsuit, or a decision in the infringement case that is favorable to the ANDA or 505(b)(2) NDA applicant.

The ANDA or 505(b)(2) NDA also will not be approved until any applicable non-patent market exclusivity listed in the Orange Book for the referenced product have expired.

#### *Market Exclusivity*

Upon NDA approval of a NCE, which is a drug that contains no active moiety that has been approved by the FDA in any other NDA, that drug receives five years of marketing exclusivity during which time the FDA cannot receive any ANDA or 505(b)(2) NDA seeking approval that uses the NDA as its RLD. Certain changes to a drug, such as the addition of a new indication to the package insert, are associated with a three-year period of exclusivity during which the FDA cannot approve an ANDA or 505(b)(2) NDA seeking approval that uses the NDA as its RLD.

An ANDA or 505(b)(2) NDA may be submitted one year before NCE exclusivity expires if a Paragraph IV certification is filed. If there is no listed patent in the Orange Book, there may not be a Paragraph IV certification, and, thus, no ANDA or 505(b)(2) may be filed before the expiration of the exclusivity period.

#### *Pediatric Exclusivity*

Another provision of the FDCA provides a potential opportunity for "pediatric exclusivity," which, if granted, adds six months to existing exclusivity periods and patent terms. This six-month exclusivity, which runs from the end of other exclusivity protection or patent term, may be granted based on the voluntary completion of a pediatric study in accordance with an FDA-issued "Written Request" for such a study. In some instances, the same studies can satisfy both PREA and pediatric exclusivity requirements, and in other instances may request studies of new indications or other differences from initial NDA approval that is being sought or has been granted.

#### *FDA Expedited Programs and Special Protocol Assessments*

The FDA expedited programs and designations for serious conditions, like Fast Track, Breakthrough Therapy, Priority Review and Accelerated Approval, are intended to make certain drugs available as rapidly as possible.

Applicants must request Fast Track designation from the FDA, which provides access to a process to facilitate the development and expedite the review of a drug intended to treat serious conditions and fill an unmet need. The request can be initiated at any time during the drug development process. The FDA will review the request and make a decision within 60 days based on whether the drug fulfills an unmet medical need in a serious condition. A drug that receives Fast Track designation is eligible for some or all of the

following: (i) more frequent meetings with FDA to discuss the drug's development plan and ensure collection of appropriate data needed to support drug approval; (ii) more frequent written correspondence from the FDA about things such as the design of the proposed clinical trial and the use of biomarkers; (iii) Accelerated Approval and Priority Review, if relevant criteria are met; and (iv) rolling review, under which the agency may initiate review of sections of a Fast Track product's NDA before the application is complete. Rolling review is available if the applicant provides, and the FDA approves, a schedule for the submission of the remaining information and the applicant pays applicable user fees. However, the FDA's PDUFA review period for a Fast Track application does not begin until the last section of the NDA is submitted.

Under the Breakthrough Therapy authority, a drug may be eligible for designation as a Breakthrough Therapy if the drug is intended, alone or in combination with one or more other drugs, to treat a serious or life-threatening condition and preliminary clinical evidence indicates that the drug may demonstrate substantial improvement over existing therapies on one or more clinically significant endpoints. If a drug is designated a Breakthrough Therapy, the FDA will expedite the development and review of the drug. Every drug application submitted to the FDA is subject to consideration for Priority Review designation, even if the applicant does not request it. The FDA informs the applicant of a Priority Review designation within 60 days of the receipt of the original NDA. Designation of a drug as "Priority" does not alter the scientific/medical standard for approval or the quality of evidence necessary for approval. Priority Review does shorten the planned time period for review of an NDA (from six months compared with the ten-month standard review) by the FDA.

Fast Track, Breakthrough Therapy and Priority Review status may all be withdrawn by the FDA at any time if the agency finds that relevant criteria are no longer being met.

Under its Accelerated Approval authority, the FDA may approve a product for a serious disease or condition that fills an unmet need, including a Fast Track product, if it is found to have an effect on a surrogate endpoint in a marker that is thought to predict a clinical benefit. The FDA may also approve a product under Accelerated Approval authority if it is found to have an effect on an intermediate endpoint in a measure of therapeutic effect that is considered reasonably likely to predict a clinical benefit. The endpoint evidence to support Accelerated Approval may be epidemiological, pathophysiological, therapeutic, and pharmacologic or based on the use of biomarkers. Accelerated Approval can be withdrawn or the labeled indication of the drug changed if studies fail to verify clinical benefit or do not demonstrate sufficient clinical benefit to justify the risk associated with the drug.

The Federal Food, Drug, and Cosmetic Act directs the FDA to meet with sponsors, pursuant to a sponsor's written request, for the purpose of reaching agreement on the design and size of clinical trials intended to form the primary basis of an efficacy claim in an NDA. If an agreement is reached, the FDA will reduce the agreement to writing and make it part of the administrative record. This agreement is called a special protocol assessment, or an SPA. While the FDA's guidance on SPAs states that documented SPAs should be considered binding on the review division, the FDA has latitude to change its assessment if certain exceptions apply. Exceptions include public health concerns emerging that were unrecognized at the time of the protocol assessment, identification of a substantial scientific issue essential to the safety or efficacy testing that later comes to light, a sponsor's failure to follow the protocol agreed upon, or the FDA's reliance on data, assumptions or information that are determined to be wrong.

An SPA request can be requested after a pre-Phase 3 meeting with the FDA. It allows the FDA and sponsor to agree on the study design for a Phase 3 study whose efficacy results will be the basis of an NDA. There is no guarantee that we will request or be able to receive and maintain Fast Track designation, Breakthrough Therapy designation, Priority Review designation, Accelerated Approval designation or a Special Protocol Assessment for any of our product candidates.

#### *Disclosure of Clinical Trial Information*

Sponsors of clinical trials of certain FDA-regulated products, including prescription drugs, are required to register and disclose certain clinical trial information on a public website maintained by the U.S. National Institutes of Health. Information related to the product, patient population, phase of investigation, clinical trial sites and investigator, and other aspects of the clinical trial is made public as part of the registration. Sponsors are also obligated to disclose the results of these clinical trials after completion if the

product candidate is ultimately approved, and disclosure of the results of these clinical trials will be delayed until such approval. Competitors may use this publicly-available information to gain knowledge regarding the design and progress of in development programs.

### ***U.S. Healthcare Regulation***

#### ***Pharmaceutical Coverage and Reimbursement***

Significant uncertainty exists as to the coverage and reimbursement status of any products for which we may obtain regulatory approval. In the United States, sales of any products for which we may receive regulatory approval for commercial sale will depend in part on the availability of coverage and reimbursement from third-party payors. Third-party payors include government authorities, managed care providers, private health insurers and other organizations. Third-party payors establish the coverage and reimbursement policies for pharmaceutical products, and the marketability of any products for which we may receive regulatory approval for commercial sale depends on those payors' coverage policies and reimbursement rates. Third-party payors may limit coverage to specific products on an approved list, or formulary, which might not include one or more of our product candidates, if approved. Third-party payors, together with regulators and others, are increasingly challenging the prices charged for pharmaceutical products and health services, in addition to their cost-effectiveness, safety and efficacy. In addition, no uniform policy for coverage and reimbursement exists in the United States. Third-party payors often rely upon Medicare coverage policy and payment limitations in setting their own coverage and reimbursement policies, but also have their own methods and approval process apart from Medicare determinations. Therefore, coverage and reimbursement rates can vary significantly from payor to payor.

Moreover, obtaining coverage and adequate reimbursement is a time-consuming and costly process. We may be required to provide scientific and clinical support for the use of any product to each third-party payor separately with no assurance that approval will be obtained, and we may need to conduct expensive pharmacoeconomic studies in order to demonstrate the cost-effectiveness of our products. We cannot be certain that our product candidates will be considered cost-effective by third-party payors. This process could delay the market acceptance of any product candidates for which we may receive approval and could have a negative effect on our future revenues and operating results.

#### ***Other U.S. Healthcare Laws and Compliance Requirements***

Our business may be subject to healthcare fraud and abuse regulation and enforcement by both the federal government and the states in which we conduct our business, particularly once third-party reimbursement becomes available for one or more of our products. The healthcare fraud and abuse laws and regulations that may affect our ability to operate include, but are not limited to:

- The federal Anti-Kickback Statute, which prohibits, among other things, knowingly and willfully soliciting, receiving, offering or paying any remuneration (including any kickback, bribe or rebate), directly or indirectly, overtly or covertly, in cash or in kind, to induce, or in return for, either the referral of an individual, or the purchase, lease, order or recommendation of any good, facility, item or service for which payment may be made, in whole or in part, under the Medicare and Medicaid programs, or other federal healthcare programs;
- The federal civil and criminal false claims laws and civil monetary penalty laws, including the civil False Claims Act, which prohibits, among other things, knowingly presenting, or causing to be presented, claims for payment of government funds that are false or fraudulent, or knowingly making, or using or causing to be made or used, a false record or statement material to a false or fraudulent claim to avoid, decrease, or conceal an obligation to pay money to the federal government;
- HIPAA, which, among other things, prohibits executing a scheme to defraud any healthcare benefit program, including private third-party payors, and prohibits (i) knowingly and willfully falsifying, concealing or covering up a material fact or making any materially false, fictitious or fraudulent statement or representation and (ii) making or using any false writing or document knowing the same to contain any materially false, fictitious or fraudulent statement or entry in connection with the delivery of or payment for healthcare benefits, items or services;

- HIPAA, as amended by the Health Information Technology for Economic and Clinical Health Act of 2009, or HITECH, and their respective implementing regulations, which impose requirements relating to the privacy, security and transmission of individually identifiable health information held by covered entities, including health plans, healthcare clearinghouses and certain healthcare providers, and their business associates, individuals or entities that perform certain services on behalf of a covered entity that involve the use or disclosure of individually identifiable health information. HITECH also created new tiers of civil monetary penalties, amended HIPAA to make civil and criminal penalties directly applicable to business associates and gave state attorneys general new authority to file civil actions for damages or injunctions in federal courts to enforce HIPAA and seek attorneys' fees and costs associated with pursuing federal civil actions;
- Federal laws that require pharmaceutical manufacturers to report certain calculated product prices to the government or provide certain discounts or rebates to government authorities or private entities, often as a condition of reimbursement under government healthcare programs;
- The federal Physician Payments Sunshine Act, being implemented as the Open Payments Program, which requires manufacturers of drugs, devices, biologics and medical supplies for which payment is available under Medicare, Medicaid or the Children's Health Insurance Program (with certain exceptions) to report annually to the CMS, information related to direct or indirect payments and other transfers of value to physicians and teaching hospitals, as well as ownership and investment interests held in a company by physicians and their immediate family members. Beginning in 2022, applicable manufacturers will also be required to report information regarding payments and transfers of value provided to physician assistants, nurse practitioners, clinical nurse specialists, certified nurse anesthetists and certified nurse-midwives; and
- U.S. state and local laws and regulations, such as state anti-kickback and false claims laws, which may apply to sales or marketing arrangements and claims involving healthcare items or services reimbursed by non-governmental third-party payors, including private insurers; state laws that require pharmaceutical companies to comply with the pharmaceutical industry's voluntary compliance guidelines and the relevant compliance guidance promulgated by the federal government or otherwise restrict payments that may be made to healthcare providers; state laws that restrict the ability of manufacturers to offer co-pay support to patients for certain prescription drugs; state laws that require drug manufacturers to report information related to clinical trials, or information related to payments and other transfers of value to physicians and other healthcare providers or marketing expenditures; state laws that require drug manufacturers to report information on the pricing of certain drugs; state laws and local ordinances that require identification or licensing of sales representatives; state and local laws regarding the manufacturing and distribution of drugs; and state laws governing the privacy and security of health information in certain circumstances, many of which differ from each other in significant ways and often are not preempted by HIPAA, thus complicating compliance efforts.

We will be required to spend substantial time and money to ensure that our business arrangements with third parties comply with applicable healthcare laws and regulations. Even then, governmental authorities may conclude that our business practices do not comply with current or future statutes, regulations or case law involving applicable fraud and abuse or other healthcare laws and regulations. If governmental authorities find that our operations violate any of these laws or any other governmental regulations that may apply to us, we may be subject to significant civil, criminal and administrative penalties, damages, fines, disgorgement, individual imprisonment, exclusion from government funded healthcare programs, such as Medicare and Medicaid, and additional reporting obligations and oversight if we become subject to a corporate integrity agreement or other agreement to resolve allegations of non-compliance with these laws, and we may be required to curtail or restructure our operations. Moreover, we expect that there will continue to be federal and state laws and regulations, proposed and implemented, that could impact our operations and business. In addition, the approval and commercialization of any product candidate we develop outside the United States will also likely subject us to foreign equivalents of the healthcare laws mentioned above, among other foreign laws. The extent to which future legislation or regulations, if any, relating to health care fraud and abuse laws or enforcement, may be enacted or what effect such legislation or regulation would have on our business remains uncertain.



### *Healthcare Reform*

In the United States there have been, and continue to be, several legislative and regulatory changes and proposed changes regarding the healthcare system that could prevent or delay marketing approval of product candidates, restrict or regulate post-approval activities, and affect the ability to profitably sell product candidates for which marketing approval is obtained. Among policy makers and payors in the United States, there is significant interest in promoting changes in healthcare systems with the stated goals of containing healthcare costs, improving quality and/or expanding access. The Patient Protection and Affordable Care Act, as amended by the Health Care and Education Reconciliation Act, collectively the Affordable Care Act, enacted in March 2010, has substantially changed healthcare financing and delivery by both governmental and private insurers. Among other things the Affordable Care Act included the following provisions:

- an annual, nondeductible fee on any entity that manufactures or imports certain specified branded prescription drugs and biologic agents apportioned among these entities according to their market share in some government healthcare programs;
- an increase in the statutory minimum rebates a manufacturer must pay under the Medicaid Drug Rebate Program;
- a new Medicare Part D coverage gap discount program, in which manufacturers must agree to offer 50% point-of-sale discounts, which through subsequent legislative amendments, will be increased to 70%, starting in 2019, off negotiated prices of applicable brand drugs to eligible beneficiaries during their coverage gap period, as a condition for the manufacturers' outpatient drugs to be covered under Medicare Part D;
- extension of manufacturers' Medicaid rebate liability to covered drugs dispensed to individuals who are enrolled in Medicaid managed care organizations;
- expansion of eligibility criteria for Medicaid programs;
- expansion of the entities eligible for discounts under the 340B Drug Discount Program;
- a Patient-Centered Outcomes Research Institute to oversee, identify priorities in, and conduct comparative clinical effectiveness research, along with funding for such research;
- a methodology by which rebates owed by manufacturers under the Medicaid Drug Rebate Program are calculated for drugs that are inhaled, infused, instilled, implanted, or injected; and
- a licensure framework for follow-on biological products.

Since its enactment, there have been numerous judicial, administrative, executive, and legislative challenges to certain aspects of the Affordable Care Act, and we expect there will be additional challenges and amendments to the Affordable Care Act in the future. Various portions of the Affordable Care Act are currently undergoing legal and constitutional challenges in the United States Supreme Court and members of Congress have introduced several pieces of legislation aimed at significantly revising or repealing the Affordable Care Act. The implementation of the Affordable Care Act is ongoing, the law appears likely to continue the downward pressure on pharmaceutical pricing, especially under the Medicare program, and may also increase our regulatory burdens and operating costs. Litigation and legislation related to the Affordable Care Act are likely to continue, with unpredictable and uncertain results.

In addition, other legislative changes have been proposed and adopted since the Affordable Care Act was enacted. On August 2, 2011, the Budget Control Act of 2011 was signed into law, which, among other things, included aggregate reductions to Medicare payments to providers of 2% per fiscal year, which went into effect on April 1, 2013 and, due to subsequent legislative amendments to the statute will remain in effect through 2030 unless additional Congressional action is taken. These reductions have been suspended from May 1, 2020 through December 31, 2020 due to the COVID-19 pandemic. The Consolidated Appropriations Act of 2021, extended the suspension period to March 31, 2021. An Act to Prevent Across-the-Board Direct Spending Cuts, and for Other Purposes, signed into law on April 14, 2021, has extended the suspension period to December 31, 2021. On January 2, 2013, the American Taxpayer Relief Act of 2012 was signed into law, which, among other things, reduced Medicare payments to several providers, including hospitals, and increased the statute of limitations period for the government to recover overpayments to providers from three to five years.



Moreover, payment methodologies may be subject to changes in healthcare legislation and regulatory initiatives. For example, CMS may develop new payment and delivery models, such as bundled payment models. In addition, recently there has been heightened governmental scrutiny over the manner in which manufacturers set prices for their commercial products, which has resulted in several Congressional inquiries and proposed and enacted state and federal legislation designed to, among other things, bring more transparency to product pricing, review the relationship between pricing and manufacturer patient programs and reform government program reimbursement methodologies for pharmaceutical products. For example, at the federal level, the previous administration's budget proposal for fiscal year 2021 included a \$135 billion allowance to support legislative proposals seeking to reduce drug prices, increase competition, lower out-of-pocket drug costs for patients and increase patient access to lower-cost generic and biosimilar drugs. On March 10, 2020, the previous administration sent "principles" for drug pricing to Congress, calling for legislation that would, among other things, cap Medicare Part D beneficiary out-of-pocket pharmacy expenses, provide an option to cap Medicare Part D beneficiary monthly out-of-pocket expenses and place limits on pharmaceutical price increases. Further, the previous administration previously released a "Blueprint" to lower drug prices and reduce out of pocket costs of drugs that contained proposals to increase drug manufacturer competition, increase the negotiating power of certain federal healthcare programs, incentivize manufacturers to lower the list price of their products and reduce the out of pocket costs of drug products paid by consumers. HHS has solicited feedback on some of these measures and has implemented others under its existing authority. For example, in May 2019, CMS issued a final rule to allow Medicare Advantage Plans the option of using step therapy, a type of prior authorization, for Part B drugs beginning January 1, 2020. This final rule codified CMS's policy change, which was effective as of January 1, 2019. Although a number of these and other measures may require additional authorization to become effective, Congress and the Biden administration have each indicated that they will continue to seek new legislative and/or administrative measures to control drug costs. Any reduction in reimbursement from Medicare and other government programs may result in a similar reduction in payments from private payors. In addition, individual states in the United States have also increasingly passed legislation and implemented regulations designed to control pharmaceutical product pricing, including price or patient reimbursement constraints, discounts, restrictions on certain product access and marketing cost disclosure and transparency measures and, in some cases, designed to encourage importation from other countries and bulk purchasing. In addition, it is possible that additional governmental action is taken to address the COVID-19 pandemic. For example, on April 18, 2020, CMS announced that qualified health plan issuers under the ACA may suspend activities related to the collection and reporting of quality data that would have otherwise been reported between May and June 2020 given the challenges healthcare providers are facing responding to the ongoing COVID-19 pandemic.

At the state level, legislatures have increasingly passed legislation and implemented regulations designed to control pharmaceutical product pricing, including price or patient reimbursement constraints, discounts, restrictions on certain product access and marketing cost disclosure and transparency measures, and, in some cases, designed to encourage importation from other countries and bulk purchasing.

Additionally, on May 30, 2018, the Right to Try Act was signed into law. The law, among other things, provides a federal framework for certain patients to access certain investigational new drug products that have completed a Phase 1 clinical study and that are undergoing investigation for FDA approval. Under certain circumstances, eligible patients can seek treatment without enrolling in clinical studies and without obtaining FDA permission under the FDA expanded access program. There is no obligation for a drug manufacturer to make its drug products available to eligible patients as a result of the Right to Try Act. If we obtain approval to market a product candidate in the United States, any healthcare reforms adverse to drug manufacturers, including but not limited to, any significant spending reductions affecting Medicare, Medicaid or other publicly funded or subsidized health programs, that may be implemented and/or any significant taxes or fees that may be imposed on us could have an adverse impact on our results of operations.

## **European Regulation**

### ***Government Regulation and Product Approval***

In order to market any product outside of the United States, a company must also comply with numerous and varying regulatory requirements of other countries and jurisdictions regarding quality, safety

and efficacy and governing, among other things, clinical trials, marketing authorization, commercial sales and distribution of products. Whether or not it obtains FDA approval for a product, an applicant will need to obtain the necessary approvals by the comparable foreign regulatory authorities before it can commence clinical trials or marketing of the product in those countries or jurisdictions. The process governing approval of biological medicinal products in the European Union generally follows the same principles as in the United States. Such products are subject to extensive pre- and post-market regulation by regulatory authorities at both the European Union and national levels.

#### ***Clinical Trial Approval***

Similar to the United States, the various phases of non-clinical and clinical research in the European Union are subject to significant regulatory controls.

Pursuant to the currently applicable Clinical Trials Directive 2001/20/EC and the Directive 2005/28/EC on GCP, a system for the approval of clinical trials in the European Union has been implemented through national legislation of the member states. Under this system, an applicant must obtain prior approval from the competent national authority of a European Union member state in which the clinical trial is to be conducted, or in multiple member states if the clinical trial is to be conducted in a number of member states. Furthermore, the applicant may only start a clinical trial at a specific site after the competent ethics committee has issued a favorable opinion. The clinical trial application must be accompanied by an investigational medicinal product dossier with supporting information prescribed by Directive 2001/20/EC and Directive 2005/28/EC and corresponding national laws of the member states and further detailed in applicable guidance documents.

In April 2014, the European Union adopted a new Clinical Trials Regulation (EU) No 536/2014, or the CTR, but it will not become effective until January 31, 2022. The CTR will overhaul the current system of approvals for clinical trials in the European Union. Specifically, the CTR, which will be directly applicable in all member states, aims at simplifying and streamlining the approval of clinical trials in the European Union. For instance, the new CTR provides for a streamlined application procedure via a single-entry point and strictly defined deadlines for the assessment of applications for authorization to conduct a clinical trial.

The CTR also establishes a Clinical Trials Information System database which will include various details of each clinical trial conducted in the EU, including the application for authorization to conduct a clinical trial and any review by a regulatory or ethics body. The CTR requires all information stored in the database to be publicly available, unless exempted under the Regulation to protect: (a) personal data; (b) commercially confidential information, in particular the marketing authorization status of the medicine, unless there is an overriding public interest; (c) confidential communication between Member States in the preparation of their assessment; or (d) supervision of clinical trials by Member States.

The CTR also clarifies the obligation to publish (a) summary results of the clinical trial within 1 year after the end of the trial (including a phase I trial); and (b) clinical study reports of the data generated in the course of the clinical trial within 30 days after the grant of the relevant marketing authorization.

The conduct of all clinical trials performed in the European Union will continue to be bound by currently applicable laws until the CTR becomes applicable. A clinical trial commenced before January 31, 2022 can continue under the current legislative framework. The sponsor of a clinical trial commenced in 2022 can elect to conduct the trial under the old legislative framework or the CTR. Any clinical trial commenced after January 31, 2023 must do so under the CTR. If a clinical trial conducted under the old legislative framework continues for more than three years after January 31, 2025, the CTR will automatically begin to apply to that clinical trial.

#### ***PRIME Designation in the European Union***

In March 2016, the EMA launched an initiative to facilitate development of product candidates in indications, often rare, for which few or no therapies currently exist. The PRiority Medicines, or PRIME, scheme is intended to encourage the development of medication in areas of unmet medical need and provides accelerated assessment of products representing substantial innovation reviewed under the centralized

procedure. Products from small- and medium-sized enterprises may qualify for earlier entry into the PRIME scheme than larger companies. Many benefits accrue to sponsors of product candidates with PRIME designation, including but not limited to, early and proactive regulatory dialogue with the EMA, frequent discussions on clinical trial designs and other development program elements, and accelerated marketing authorization application assessment once a dossier has been submitted. Importantly, a dedicated EMA contact and rapporteur from the Committee for Human Medicinal Products, or CHMP, are appointed early in the PRIME scheme facilitating increased understanding of the product at the EMA's Committee level. A kick-off meeting initiates these relationships and includes a team of multidisciplinary experts at the EMA to provide guidance on the overall development and regulatory strategies.

#### ***Marketing Authorization***

To obtain marketing authorization of a biological medicinal product under the European Union regulatory system, an applicant must submit a marketing authorization application, or MAA, either under a centralized procedure administered by the EMA or one of the procedures administered by competent authorities in the European Union member states: the decentralized procedure, national procedure, or mutual recognition procedure. A marketing authorization may be granted only to an applicant established in the European Union.

The centralized procedure provides for the grant of a single marketing authorization by the European Commission that is valid for all European Union member states. Pursuant to Regulation (EC) No. 726/2004, the centralized procedure is compulsory for specific products, including for medicines produced by certain biotechnological processes, products designated as orphan medicinal products, advanced therapy products and products with a new active substance indicated for the treatment of certain diseases, including products for the treatment of viral diseases and cancer. For those products for which the use of the centralized procedure is not mandatory, applicants may elect to use the centralized procedure where either the product contains a new active substance not yet authorized in the European Union, or where the applicant can show that the product constitutes a significant therapeutic, scientific or technical innovation or for which a centralized process is in the interest of patients at a European Union level.

Under the centralized procedure, the CHMP is responsible for conducting an initial assessment of whether a product meets the required quality, safety and efficacy requirements, and whether a product has a positive benefit/risk profile. Under the centralized procedure in the European Union, the maximum timeframe for the evaluation of an MAA is 210 days from receipt of a valid MAA, excluding clock stops when additional information or written or oral explanation is to be provided by the applicant in response to questions of the CHMP. Clock stops may extend the timeframe of evaluation of an MAA considerably beyond 210 days. Where the CHMP gives a positive opinion, it provides the opinion together with supporting documentation to the European Commission, who make the final decision to grant a marketing authorization, which is issued within 67 days of receipt of the EMA's recommendation. Accelerated evaluation may be granted by the CHMP in exceptional cases, when a medicinal product is of major interest from the point of view of public health and, in particular, from the viewpoint of therapeutic innovation. If the CHMP accepts such a request, the timeframe of 210 days for assessment will be reduced to 150 days (excluding clock stops), but it is possible that the CHMP may revert to the standard time limit for the centralized procedure if it determines that the application is no longer appropriate to conduct an accelerated assessment.

For products not falling within the mandatory scope of the centralized procedure, national marketing authorizations may be obtained, which are issued by the competent authorities of the European Union member states and only cover their respective territory. Where a product has already been authorized for marketing in an European Union member state, this national marketing authorization can be recognized in another European Union member state through the mutual recognition procedure. If the product has not received a national marketing authorization in any member state at the time of application, it can be approved simultaneously in various European Union member states through the decentralized procedure. As with the centralized procedure, the competent authorities of the European Union member states assess the risk-benefit balance of the product on the basis of scientific criteria concerning its quality, safety and efficacy before granting the marketing authorization.

### ***Pediatric Studies***

Prior to obtaining a marketing authorization in the European Union, companies developing a new medicinal product must agree upon a Pediatric Investigation Plan, or PIP, with the EMA's Pediatric Committee, or PDCO, and must conduct pediatric clinical trials in accordance with that PIP, unless a waiver applies, (e.g., because the relevant disease or condition occurs only in adults). The PIP sets out the timing and measures proposed to generate data to support a pediatric indication of the drug for which marketing authorization is being sought. The MAA for the product must include the results of pediatric clinical trials conducted in accordance with the PIP, unless a waiver applies, or a deferral has been granted by the PDCO of the obligation to implement some or all of the measures of the PIP until there are sufficient data to demonstrate the efficacy and safety of the product in adults, in which case the pediatric clinical trials must be completed at a later date. Products that are granted a marketing authorization with the results of pediatric clinical trials conducted in accordance with the PIP are eligible for a six month extension of the protection under a supplementary protection certificate (if any is in effect at the time of approval) even where the trial results are negative. In the case of orphan medicinal products, a two year extension of the orphan market exclusivity may be available. This pediatric reward is subject to specific conditions and is not automatically available when data in compliance with the PIP are developed and submitted.

### ***Data and Marketing Exclusivity***

The European Union also provides opportunities for market exclusivity. Upon receiving marketing authorization in the European Union, innovative medicinal products generally receive eight years of data exclusivity and an additional two years of market exclusivity. Data exclusivity prevents the regulatory authorities from accepting MAAs from generic or biosimilar applicants seeking to rely on the innovator's preclinical and clinical trial data contained in the dossier of the reference product when applying for a generic or biosimilar marketing authorization in the European Union for a period of eight years from the date on which the reference product was first authorized in the European Union. During an additional two-year period of market exclusivity, a generic or biosimilar MAA can be submitted, and the innovator's data may be referenced and relied on, but no generic or biosimilar product can be marketed until the expiration of the additional two-year market exclusivity period. The overall ten-year period will be extended to a maximum of eleven years if, during the first eight years of those ten years, the marketing authorization holder obtains an authorization for one or more new therapeutic indications which, during the scientific evaluation prior to authorization, is held to bring a significant clinical benefit in comparison with existing therapies. Even if a compound is considered to be a new chemical entity so that the innovator gains the prescribed period of data exclusivity, another company may market another version of the product if such company obtained marketing authorization based on an MAA with a complete independent data package including preclinical tests and clinical trials.

### ***Patent Term Extensions in the European Union and Other Jurisdictions***

The European Union also provides for patent term extension through Supplementary Protection Certificates, or SPCs. The rules and requirements for obtaining a SPC are similar to those in the United States. An SPC may extend the term of a patent for up to five years after its originally scheduled expiration. In certain circumstances, these periods may be extended for six additional months if pediatric exclusivity is obtained, which is described in detail below. Although SPCs are available throughout the European Union, sponsors must apply on a country-by-country basis. Similar patent term extension rights exist in certain other foreign jurisdictions outside the European Union.

### ***Periods of Authorization and Renewals***

A marketing authorization is valid for five years, in principle, and it may be renewed after five years on the basis of a reevaluation of the risk-benefit balance by the EMA or by the competent authority of the authorizing member state. To that end, the marketing authorization holder must provide the EMA or the competent authority in a Member State with a consolidated version of the file in respect of quality, safety and efficacy, including all variations introduced since the marketing authorization was granted, at least six months before the marketing authorization ceases to be valid. Once renewed, the marketing authorization is valid for an unlimited period, unless the European Commission or the competent authority decides, on

justified grounds relating to pharmacovigilance, to proceed with one additional five-year renewal period. Any authorization that is not followed by the placement of the medicine on the European Union market (in the case of the centralized procedure) or on the market of the authorizing member state within three years after authorization ceases to be valid.

#### ***Regulatory Requirements After Market Authorization***

Following approval, the holder of the marketing authorization is required to comply with a range of requirements applicable to the manufacturing, marketing, promotion and sale of the medicinal product. These include compliance with the European Union's stringent pharmacovigilance or safety reporting rules, pursuant to which post-authorization studies and additional monitoring obligations can be imposed. In addition, the manufacturing of authorized products, for which a separate manufacturer's license is mandatory, must also be conducted in strict compliance with the EMA's cGMP requirements and comparable requirements of other regulatory bodies in the European Union, which mandate the methods, facilities and controls used in manufacturing, processing and packing of medicines to assure their safety and identity. Finally, the marketing and promotion of authorized products, including industry-sponsored continuing medical education and advertising directed toward the prescribers of medicinal products and/or the general public, are strictly regulated in the European Union. It is prohibited to advertise prescription-only medicinal products to patients in the EU.

#### ***Orphan Designation and Exclusivity***

An orphan designation provides a number of benefits, including fee reductions, regulatory assistance and the possibility to apply for a centralized European Union marketing authorization. Marketing authorization for an orphan medicine leads to a ten-year period of market exclusivity. During this market exclusivity period, neither the EMA nor the European Commission or the member states can accept an application for, or grant a marketing authorization for, a "similar medicinal product." A "similar medicinal product" is defined as a medicinal product containing a similar active substance or substances as contained in an authorized orphan medicinal product, and which is intended for the same therapeutic indication. The market exclusivity period for the authorized therapeutic indication may, however, be reduced to six years if, at the end of the fifth year, it is established that the product no longer meets the criteria for orphan designation because, for example, the product is sufficiently profitable not to justify market exclusivity.

The criteria for designating an orphan medicine in the European Union are similar in principle to those in the United States. Regulation (EC) No 141/2000 and Regulation (EC) No. 847/2000 provide that a product can be designated as an orphan medicine by the European Commission if its sponsor can establish: that the product is intended for the diagnosis, prevention or treatment of (1) a life threatening or chronically debilitating condition affecting not more than 5 in 10,000 persons in the European Union when the application is made, or (2) a life-threatening, seriously debilitating or serious and chronic condition in the European Union and that without incentives it is unlikely that the marketing of the medicine in the European Union would generate sufficient return to justify the necessary investment. For either of these conditions, the applicant must demonstrate that there exists no satisfactory method of diagnosis, prevention or treatment of the condition in question that has been authorized in the European Union or, if such method exists, the medicine will be of significant benefit to those affected by that condition.

Orphan medicines are eligible for financial incentives such as reduction of fees or fee waivers made available by the European Union and its member states to support research into, and the development and availability of, orphan medicines. The application for orphan designation must be submitted before the application for marketing authorization. The applicant will receive a fee reduction for the MAA if the orphan designation has been granted, but not if the designation is still pending at the time the marketing authorization is submitted. Orphan designation does not convey any advantage in, or shorten the duration of, the regulatory review and approval process.

#### ***Pediatric Exclusivity***

If an applicant obtains a marketing authorization in all European Union member states, or a marketing authorization granted in the centralized procedure by the European Commission, and the study results for

the pediatric population are included in the product information, even when negative, the medicine is then eligible for an additional six-month period of qualifying patent protection through extension of the term of the SPC.

#### ***Brexit and the Regulatory Framework in the United Kingdom***

In June 2016, the electorate in the United Kingdom voted in favor of leaving the European Union (commonly referred to as “Brexit”). Thereafter, in March 2017, the country formally notified the European Union of its intention to withdraw pursuant to Article 50 of the Lisbon Treaty. The UK formally left the European Union on January 31, 2020. There was a transitional period, during which European Union laws continued to apply in the UK, which ended on December 31, 2020. The UK and European Union have signed an EU-UK Trade and Cooperation Agreement, which became provisionally applicable on January 1, 2021 and which will become formally applicable once ratified by both the UK and the European Union. This agreement provides details on how some aspects of the UK and European Union’s relationship regarding medicinal products will operate, particularly in relation to Good Manufacturing Practice; however, there are still many uncertainties. Since the regulatory framework for medicinal products in the UK covering quality, safety and efficacy of medicinal products, clinical trials, marketing authorization, commercial sales and distribution of medicinal products is derived from European Union directives and regulations, the current regulatory framework in the UK is virtually identical to the framework in the European Union. The EU Clinical Trials Regulation (described in detail above), which is due to take effect on January 31, 2022, will not apply in Great Britain, but it will apply in Northern Ireland (as a result of the Northern Ireland Protocol).

However, post-Brexit, the UK Government is free to adopt laws that could diverge from the laws in the European Union. This could materially impact the future regulatory regime which applies to products and the approval of product candidates in the UK. It remains to be seen how Brexit will impact regulatory requirements for product candidates and products in the UK in the long-term. In the meantime, the Medicines and Healthcare products Regulatory Agency, the UK medicines and medical devices regulator, has published detailed guidance for industry and organizations to follow.

#### ***Pricing and Reimbursement Environment***

Even if a medicinal product obtains a marketing authorization in the European Union, there can be no assurance that reimbursement for such product will be secured on a timely basis or at all. Pricing and reimbursement of medicines is a matter reserved to individual Member States. Each Member State is free to restrict the range of medicinal products for which their national health insurance systems provide reimbursement, and to control the prices and reimbursement levels of medicinal products for human use. Each Member State may approve a specific price or level of reimbursement for the medicinal product, or alternatively adopt a system of direct or indirect controls on the profitability of the company responsible for placing the medicinal product on the market, including volume-based arrangements, caps and reference pricing mechanisms.

#### **PRC Regulation**

##### ***PRC Drug Regulation***

The Drug Administration Law of the PRC, or the Drug Administration Law, promulgated by the Standing Committee of the NPC and the Implementing Measures of the Drug Administration Law, or the Implementing Measures of the Drug Administration law, promulgated by the State Council, have jointly established the legal framework for the administration of pharmaceutical products in China, including the research, development and manufacturing of new drugs. The Drug Administration Law applies to entities and individuals engaged in the development, production, trade, application, supervision and administration of pharmaceutical products, and regulates and provides a framework for the administration of pharmaceutical manufacturers, pharmaceutical trading companies and medicinal preparations of medical institutions, and the development, research, manufacturing, distribution, packaging, pricing and advertisements of pharmaceutical products. The Implementing Measures of the Drug Administration Law, on the other hand, provides detailed implementation regulations for the Drug Administration Law.

The recent amendment to the Drug Administration Law, which became effective in December 2019, brought a series of changes to the drug supervision and administration system, including, but not limited to, the clarification of the drug marketing authorization holder system, pursuant to which each marketing authorization holder shall assume responsibilities for non-clinical trials, clinical trials, manufacturing and marketing, post-marketing studies, monitoring, reporting and handling of any adverse reactions of its drugs. The amendment also stipulates that the State supports the innovation of drugs with clinical value and specific or special effects on human diseases, encourages the development of drugs with new therapeutic mechanisms and that have multi-targeted, systematic regulatory and intervention functions on the human body and promotes the technological advancement of drugs. The NMPA has since promulgated two key implementing regulations for the amended Drug Administration Law: (i) the amended Administrative Measure for Drug Registration and (ii) the amended Measures on the Supervision and Administration of the Manufacture of Drugs. Both took effect on July 1, 2020. The NMPA also promulgated the Chemical Drug Registration Classification and Application Data Requirements in June 2020 as detailed implementing rules on drug classification.

We are required to follow the above-mentioned regulations in respect of our non-clinical research, clinical trials and production of new drugs.

#### *Regulatory Authorities and Recent Government Reorganization*

Pharmaceutical products and medical devices and equipment in China are monitored and supervised on a national scale by the NMPA (formerly known as China Food and Drug Administration, or the CFDA), while the local provincial medical products administrative authorities are responsible for the supervision and administration of drugs within their respective administrative regions. Pursuant to the Decision of the First Session of the Thirteenth National People's Congress on the State Council Institutional Reform Proposal made by the NPC in March 2018, the NMPA is no longer an independent agency and its duties shall be performed by the newly established State Administration for Market Regulation, or the SAMR, into which the various agencies responsible for, among other areas, consumer protection, advertising, anticorruption, pricing, fair competition and intellectual property, have been merged.

The NMPA is still however the chief drug regulatory agency and implements the same laws, regulations, rules, and guidelines as the CFDA, and the NMPA regulates almost all of the key stages of the life cycle of pharmaceutical products, including non-clinical trials, clinical trials, marketing approvals, manufacturing, advertising and promotion, distribution, and pharmacovigilance (*i.e.*, post-marketing safety reporting obligations). The Center for Drug Evaluation, or the CDE, which remains under the NMPA, conducts the technical evaluation of each drug and biologic application for safety and efficacy.

Formed on March 2018, the National Health Commission, or the NHC, (formerly known as the Ministry of Health, or the MOH, and the National Health and Family Planning Commission, or the NHFPC), is China's chief healthcare regulator. It is primarily responsible for overseeing the operation of medical institutions, which also serve as clinical trial sites, and regulating the licensure of hospitals and medical personnel.

#### *Non-Clinical Research*

In 2003, the NMPA promulgated the Administrative Measures for Good Laboratories Practice of Non-clinical Laboratory, which was revised on in July 2017, to improve the quality of non-clinical research, and began conducting the Good Laboratories Practice certification program. Pursuant to the Circular on Administrative Measures for Certification of GLP for Non-clinical Laboratory issued by the NMPA in April 2007, the NMPA is responsible for the certification of non-clinical research institutions nationwide and local provincial medical products administrative authorities are in charge of the daily supervision of non-clinical research institutions. The NMPA decides whether an institution is qualified for undertaking pharmaceutical non-clinical research by evaluating such institution's organizational administration, its research personnel, its equipment and facilities, and its operation and management of non-clinical pharmaceutical projects. A GLP Certification will be issued by the NMPA if all the relevant requirements are satisfied, and such certification will be published on the NMPA's website.



### *Preclinical Development*

The NMPA requires supporting preclinical data for the registration applications for imported and domestic drugs. Preclinical work, including pharmacology and toxicology studies, must satisfy the requirements of the Administrative Measures for Good Laboratories Practice of Non-clinical Laboratory. No approval is required from the NMPA to conduct preclinical studies.

### *Clinical Trials and Marketing Approval of New Drugs*

#### **Registration Categories**

Pursuant to the Administrative Measures for Drug Registration in January 2020 and effective on July 1, 2020, which provides the standards and requirements for clinical trials and drug registration applications. Drug marketing registration applications are divided into three categories, namely traditional Chinese drugs, chemical drugs and biological products, and each type is further divided into several sub-types. For example, the registration applications of chemical drugs are further categorized by innovative chemical drugs, improved new chemical drugs, and generic chemical drugs, among others. As provided in the Administrative Measures for Drug Registration, the Drug Administration Law and Implementing Measures of the Drug Administration Law, upon completion of non-clinical research, clinical trials shall be conducted for the application of new drug registration, upon approval from NMPA or authorized institutions.

Prior to engaging with the NMPA on research and development approval, an applicant shall determine the registration category for its product candidate (subject to ultimate confirmation by the NMPA), which will determine the requirements for its clinical trial and marketing application. There are five categories for chemical drugs: Category 1, or innovative drugs, refers to drugs with NCEs that have not been marketed anywhere in the world; Category 2, or improved new drugs, refers to drugs with a new indication, dosage form, route of administration, combination or certain formulation changes not previously approved anywhere in the world; Categories 3 and 4 refer to generic drugs that reference an innovator drug (or certain well-known generic drugs) marketed either abroad or in China, respectively; and Category 5 refers to innovative or generic drugs that have already been marketed abroad but are not yet approved in China (*i.e.*, various imported drugs).

#### **Priority Review Program under Current Reform Frame**

The NMPA has adopted several expedited review and approval mechanisms since 2009 and created additional expedited programs in recent years that are intended to encourage innovation. Applications for these expedited programs can be submitted after the clinical trial application is admitted for review by the CDE. The newly amended Administrative Measures for Drug Registration, which became effective on July 1, 2020, set up several acceleration procedures for drug marketing registration including procedures for breakthrough therapy designation drugs, procedures for conditional approval, procedures for priority review and approval at the marketing authorization application stage and procedures for special approval in public health emergencies. In order to implement the amended Administrative Measures for Drug Registration, on July 7, 2020, the NMPA promulgated the specific working procedures for the evaluation of breakthrough therapy designation drugs, conditional approvals and priority review and approval at the marketing authorization application stage which replaced the previous priority evaluation and approval program. According to such working procedures, a priority review market authorization pathway may be available to the following drugs with distinctive clinical benefits: (i) drugs in short supply for urgent clinical need, innovative drugs and modified new drugs for the prevention and treatment of serious infectious diseases, rare diseases and other diseases; (ii) pediatric drugs of new varieties, dosage forms and specifications that meet the physiological characteristics of children; (iii) vaccines urgently needed for disease prevention and control and innovative vaccines; (iv) drugs included in the procedures for breakthrough therapy designation drugs; (v) drugs fulfilling the requirements for conditional approval; and (vi) other drugs for priority review and approval stipulated by the NMPA.

We believe that our current clinical stage product candidate could be classified as a drug under categories (i) and (ii) of the working procedures described above. Therefore, we may be entitled to the priority review market authorization pathway under the newly amended Administrative Measures for Drug Registration.



### **Clinical Trial Approval**

All clinical trials conducted in China for the purpose of seeking marketing approval must be approved and conducted at a pharmaceutical clinical trial institution which shall be under filing administration.

In addition, the NMPA has adopted a notification system for clinical trials of new drugs. Pursuant to the *Opinions on Deepening the Reform of the Evaluation and Approval Systems and Encouraging Innovation on Drugs and Medical Devices, or the Innovation Opinion*, the Announcement on Adjusting the Evaluation and Approval Procedure of Drug Clinical Trial and the newly amended Drug Administration Law, clinical trials may be commenced as long as the applicant has not received any objections from the CDE within 60 business days of application filing.

#### *International Multi-center Clinical Trials Regulations*

In January 2015, the NMPA promulgated the Notice on Issuing the International Multi-Center Clinical Trial Guidelines (Trial) to provide guidance on the regulation of the application, implementation and administration of international multi-center clinical trials in China. Pursuant to the Notice on Issuing the International Multi-Center Clinical Trial Guidelines (Trial), international multi-center clinical trial applicants may simultaneously perform clinical trials in different centers using the same clinical trial protocol. Where the applicant plans to make use of the data derived from the international multi-center clinical trials for its application to the NMPA for approval of an NDA, such international multi-center clinical trials shall satisfy, in addition to the requirements set forth in the Drug Administration Law and its implementation measures, the Administrative Measures for Drug Registration and other relevant laws and regulations, the following requirements:

- The applicant shall first conduct an overall evaluation on the global clinical trial data and further make trend analysis of the Asian and Chinese clinical trial data. In the analysis of Chinese clinical trial data, the applicant shall consider the representativeness of the research subjects, *i.e.*, the participating patients;
- The applicant shall analyze whether the amount of Chinese research subjects is sufficient to assess and adjudicate the safety and effectiveness of the drug under clinical trial, and satisfy the statistical and relevant legal requirements; and
- The onshore and offshore international multi-center clinical trial research centers shall be subject to on-site inspections by competent PRC governmental agencies.

International multi-center clinical trials shall follow international prevailing the Good Clinical Trial Practice, or GCTP, principles and ethics requirements. Applications shall ensure the truthfulness, reliability and trustworthiness of clinical trials results; the researchers shall have the qualification and capability to perform relevant clinical trials; and an ethics committee shall continuously review the trials and protect the subjects' interests, benefits and safety. Before the performance of the international multi-center clinical trial, applicants shall obtain clinical trial approvals or complete filings pursuant to requirements under the local regulations where clinical trials are conducted, and register and disclose the information of all major researchers and clinical trial organizations on the NMPA drug clinical trial information platform.

Pursuant to the Innovation Opinion, clinical trial data obtained from foreign centers may be used to apply for marketing application in China as long as such data meet the relevant requirements for the registration of drugs and medical devices in China. When using international multi-center clinical trial data to support marketing application in China, applicants shall provide the clinical trial data on racial difference, if any.

#### **Trial Exemptions and Acceptance of Foreign Data**

The NMPA may reduce its requirements for clinical trials and data, depending on the drug and the existing data. The NMPA has granted waivers for all or part of trials and has stated that it will accept data generated abroad (even if not as part of a global study), including early phase data, that meets its requirements. In July 2018, the NMPA issued the Technical Guidance Principles on Accepting Foreign Drug Clinical Trial Data, or the Guidance Principles, as one of the implementing rules for the Innovation Opinion.

According to the Guidance Principles, the data of foreign clinical trials must meet certain authenticity, completeness, accuracy and traceability requirements, and such data must be obtained in consistency with the relevant requirements under the GCTP of the International Conference on Harmonization of Technical Requirements for Registration of Pharmaceuticals for Human Use. Additionally, clinical trial sponsors must be attentive to potentially meaningful ethnic differences in the subject population.

The NMPA permits drugs approved outside of China to be approved in China on a conditional basis without pre-approval clinical trials being conducted in China. Specifically, in 2018, the NMPA issued the Procedures for Reviewing and Approval of Clinical Urgently Needed Overseas New Drugs, permitting drugs that have been approved within the last ten years in the United States, the European Union or Japan and that prevent or treat orphan diseases or prevent or treat serious life-threatening illnesses for which there is either no effective therapy in China or for which the foreign-approved drug would have clear clinical advantages. Applicants are required to establish a risk mitigation plan and may be required to complete trials in China after the drug has been marketed. The CDE has developed a list of qualifying drugs that meet the foregoing criteria.

#### *Drug Clinical Trial Registration*

Pursuant to the Announcement on Drug Clinical Trial Information Platform released by the NMPA in September 2013, for all clinical trials approved by the NMPA and conducted in China, clinical trial registration must be completed and trial information must be published through the drug clinical trial information platform. In July 2020, the CDE released the Drug Clinical Trial Registration and Information Disclosure Practices (Trial). Under these measures, an applicant who has obtained the approval from the NMPA for a clinical trial and intends to conduct the clinical trial in China must complete trial pre-registration before starting the clinical trial and must also continue to update follow-up information according to the progress of clinical trial. If no subject has signed an informed consent within three years from the date of approval from the NMPA for the clinical trial, the approval will be automatically invalidated and the registration will not be granted.

#### **Human Genetic Resources Approval**

In 1998, the Ministry of Science and Technology and the MOH jointly established the rules for protecting and utilizing human genetic resources in China. In July 2015, the Ministry of Science and Technology issued the Service Guide for Administrative Licensing Items concerning Examination and Approval of Sampling, Collecting, Trading, Exporting Human Genetic Resources, or Taking Such Resources out of the PRC, which provides that foreign-invested drug marketing authorization applicants (*i.e.*, sponsors) that sample and collect human genetic resources in clinical trials shall be required to make certain filings with the China Human Genetic Resources Management Office, or the HGRMO, through its online system. In October 2017, the Ministry of Science and Technology issued the Circular on Optimizing the Administrative Examination and Approval of Human Genetic Resources, which simplified the approval for sampling and collecting human genetic resources for the purpose of commercializing a drug in the PRC.

In May 2019, the State Council of PRC issued the National Regulations on the Management of Human Genetic Resources, which formalized the approval requirements pertinent to research collaborations between Chinese and foreign-owned entities. Pursuant to this new rule, a new notification system (as opposed to the advance approval approach originally in place) has been established for clinical trials using China's human genetic resources at clinical institutions without involving the export of human genetic resources outside of China. Under the new system, a notification filing, specifying, among other things, the type, quantity and usage of the human genetic resource, with the HGRMO is required before conducting such clinical trials. The collection and use of China's human genetic resources in international collaboration on basic scientific research involving the export of such human genetic resources are still subject to the approval of the HGRMO.

#### **Clinical Trial Process and Good Clinical Practices**

Typically, drug clinical trials in China have four phases. Phase 1 refers to the initial clinical pharmacology and human safety evaluation studies. Phase 2 refers to the preliminary evaluation of a product candidate's therapeutic efficacy and safety for target indication(s) in patients. Phase 3 (often the pivotal study) refers to

clinical trials that further verify the product candidate's therapeutic efficacy and safety on patients with target indication(s) and ultimately provide sufficient evidence for the review of a drug marketing application. Phase 4 refers to a new drug's post-marketing study, which may be required by NMPA at its sole discretion, to assess therapeutic effectiveness and adverse reactions when the drug is widely used, to evaluate overall benefit-risk relationships of the drug when used among the general population or specific groups and to adjust the administration dose, etc.

Pursuant to the NMPA, a clinical trial institution can be engaged by a sponsor to conduct a drug clinical trial after such institution has been duly recorded with the online platform designated by the NMPA. The newly amended Drug Administrative Law and the Regulations on the Administration of Drug Clinical Trial Institution jointly promulgated by the NMPA and the NHC specify the requirements for clinical trial institutions and recording procedures. Pursuant to these regulations, a clinical trial institution should comply with the requirements of cGCP and be capable of undertaking pharmaceutical clinical trials. It should evaluate or engage a third party to evaluate its clinical trial proficiency, facilities and expertise. According to the Implementing Regulations of the Drug Administration Law, a sponsor should only engage a duly recorded clinical trial institution to carry out a drug clinical trial.

The conduct of clinical trials must adhere to the cGCP and the protocols approved by the ethics committees of each study site. All applicants of pending drug registration submissions must conduct self-inspection and verification of their clinical trial data.

In April 2020, the NMPA and the NHC released the amended Good Clinical Practice for Pharmaceutical Product, or the Amended GCP, which took effect on July 1, 2020. Compared to the cGCP, the Amended GCP provides comprehensive and substantive requirements on the design and conduct of clinical trials in China. In particular, the Amended GCP enhances the protection for study subjects and tightens the control over bio-samples collected under clinical trials. In addition, the Amended GCP requires that trial drugs shall be manufactured in compliance with pertinent requirements on good manufacturing of drugs for clinical trial and used in line with relevant trial protocols. The NMPA issued the consultation paper of Good Manufacturing Practice for Drugs Used in Clinical Trials in July 2018.

#### *Communication with the CDE*

Pursuant to the Administrative Measures for Communication on the Research, Development and Technical Evaluation of Drugs promulgated by the NMPA on December 10, 2020, the applicants may propose to conduct communication meetings with the CDE during the research and development periods and in the registration applications of the innovative drugs. The communication meetings can be classified into three types. Type I meetings are convened to address key safety issues in clinical trials of drugs and key technical issues in the research and development of breakthrough therapeutic drugs. Type II meetings are held during the key research and development periods of drugs, mainly including meetings before the clinical trial application, meetings upon the completion of Phase 2 trials and before the commencement of Phase 3 trials, meetings before submitting a drug marketing application, and meetings for risk evaluation and control. Type III meetings refer to meetings that are not classified as Type I or Type II. According to the new Administrative Measures for Communication on the Research, Development and Technical Evaluation of Drugs, the applicant who apply for conditional approval and/or the priority review and approval procedures shall communicate with the CDE and obtain confirmation before submitting the marketing application to NMPA. In addition, except for (i) clinical trial of new drugs with clear technical guidelines, mature research experience, and guaranteed quality of the application materials, or (ii) international multi-center clinical trials that are simultaneously developed internationally and have been approved to conduct clinical trials in countries and/or regions with sound regulatory systems, the applicant in principle shall apply for communication with the CDE before clinical trial application for new drugs. Furthermore, where the application for clinical trials of new drug has been approved, upon the completion of Phase 1 and 2 clinical trials and prior to Phase 3 clinical trial, or before submitting a drug marketing application, the applicant may submit the application for Communication Session to the CDE.

#### *Drug Marketing Registration Application*

Pursuant to the newly amended Administrative Measures for Drug Registration, the applicant may submit an application for drug marketing registration to the CDE upon completion of relevant research on

pharmacy, pharmacology, toxicology and drug clinical trials, determination of the quality standards of the drug, validation of commercial-scale production processes and preparation for acceptance of verification and inspection conducted by a professional technical institution designated as competent by the NMPA. The CDE will organize pharmaceutical, medical and other technicians to conduct comprehensive review of the safety, efficacy and quality controllability, among others, of the drug according to the application materials submitted by the applicant, the results of the verification and inspection conducted by a professional technical institution, etc. If the comprehensive review conclusion is affirmative, the drug shall be approved for marketing and a drug registration certificate will be issued containing the information of the drug approval number, the marketing authorization holders and the manufacturer.

#### *Drug technology transfer regulations*

In August 2009, the NMPA promulgated the Administrative Regulations for Technology Transfer Registration of Drugs to standardize the registration process of drug technology transfers, which include application for, and evaluation, examination, approval and monitoring of, drug technology transfers. Drug technology transfers refer to the transfer of drug production technology by the owner to a drug manufacturer and the application for drug registration by the transferee according to the provisions in the new regulations. Drug technology transfers include new drug technology transfers and drug production technology transfers.

#### ***Manufacturing and Distribution***

According to the newly amended Drug Administration Law, the Regulations of Implementation of the Drug Administration Law and the Measures on the Supervision and Administration of the Manufacture of Drugs, facilities that manufacture drugs in China must receive a drug manufacturing license from the local drug regulatory authority. Each drug manufacturing license issued to a pharmaceutical manufacturing enterprise is effective for a period of five years. Any enterprise holding a drug manufacturing license is subject to review by the relevant regulatory authorities on an annual basis. According to such regulations and measures, to the extent a marketing authorization holder manufactures its drugs internally and not through CMOs, such marketing authorization holder must apply for a drug manufacturing license with the provincial counterpart of the NMPA, subject itself to inspections and other regulatory oversight by the agency.

Similarly, to conduct sales, importation, shipping and storage, or collectively, the distribution activities, a company must obtain a Drug Distribution License from the local drug regulatory authority, subject to renewal every five years. A separate certification of compliance with the NMPA's drug good supply practice is also required.

China has implemented a "Two-Invoice System" to control the distribution of prescription drugs. The "Two-Invoice System" generally requires that no more than two invoices be issued throughout the distribution chain: one from the manufacturer to a distributor and another from the distributor to the end-user hospital. This excludes the sale of products invoiced from the manufacturer to its wholly-owned or controlled distributors, or for imported drugs, to its exclusive distributor, or from a distributor to its wholly-owned or controlled subsidiary (or between its wholly-owned or controlled subsidiaries). However, the system still significantly limits the options for companies to use multiple distributors to reach a larger geographic area in China. Compliance with the Two-Invoice System is a prerequisite for pharmaceutical companies to participate in the procurement processes of public hospitals, which currently provide most of China's healthcare services. Manufacturers and distributors that fail to implement the Two-Invoice System may lose their qualifications to participate in the bidding process. Non-compliant manufacturers may also be blacklisted from engaging in drug sales to public hospitals in a locality.

#### *Administrative Observation Periods for New Drugs*

According to the Implementing Measures of the Drug Administration Law, the NMPA may, for the purposes of protecting public health, set an administrative observation period of not more than five years for a new drug produced by a drug manufacturer. During the administrative observation period, no approval shall be given to any other manufacturer to produce or import the said drug.

*Non-Inferiority Standard*

In China, a drug may receive regulatory approval without showing superiority in its primary endpoint. Rather, a drug may be approved for use if it shows non-inferiority in its primary endpoint and superiority in one of its secondary endpoints.

*Packaging of Pharmaceutical Products*

Pursuant to the Administration of Quality of Drug Clinical Practice, the applicant shall be responsible for proper packaging and labeling of drugs for clinical trials, and in double-blinded clinical trials, the test drug shall be consistent with the control drug or placebo in appearance, odor, packaging, labeling and certain other features. According to the Measures for the Administration of Pharmaceutical Packaging promulgated in February 1988, pharmaceutical packaging must comply with national and professional standards. If there is no national or professional standard available, an applicant may formulate and implement its own standards after obtaining the approval of the provincial administration or bureau of standards. The applicant must reapply if it needs to change its own packaging standards. Drugs that have not developed and received approval for packaging standards must not be sold or marketed in the PRC (except for drugs for the military).

*Advertising of Pharmaceutical Products*

Pursuant to the Interim Administrative Measures for the Review of Advertisements for Drugs, Medical Devices, Health Food and Formula Food for Special Medical Purposes promulgated in December 2019, an enterprise seeking to advertise its pharmaceutical products must apply for an advertisement approval number. The advertisement approval number is issued by the relevant local administrative authority. The validity term of the advertisement approval number for drugs shall be consistent with the shortest validity term of the production registration certificate, filing certificate or production license. If no valid term is prescribed in the production registration certificate, filing certificate or production license, the valid term of the advertisement approval number shall be two years. The content of an approved advertisement may not be altered without prior approval.

*Insert Sheet and Labels of Pharmaceutical Products*

According to the Measures for the Administration of the Insert Sheets and Labels of Drugs, the insert sheets and labels of drugs should be reviewed and approved by the NMPA. A drug insert sheet should include the scientific data, conclusions and information concerning drug safety and efficacy in order to direct the safe and rational use of drugs. The inner label of a drug should bear such information as the drug's name, indication or function, strength, dose and usage, production date, batch number, expiry date and drug manufacturer, and the outer label of a drug should indicate such information as the drug's name, ingredients, description, indication or function, strength, dose and usage and adverse reaction.

*Regulatory Intellectual Property Protections*

In January 2020, the United States and China signed the Economic and Trade Agreement Between the United States of America and the PRC (the "Trade Agreement"). Among other things, China agreed to provide for effective protection and enforcement of pharmaceutical-related intellectual property rights, including patents and undisclosed test or other data submitted as a condition of marketing approval, as further described below. These provisions of the Trade Agreement will need to be implemented in China. In October 2020, the Standing Committee of the NPC promulgated the amended PRC Patent Law, which became effective in June 2021. The newly amended PRC Patent Law sets up the framework and adds the provisions for patent linkage and patent term extension. However, the provisions for patent term extension and an early resolution mechanism are unclear and/or remain subject to the approval of implementing regulations that are still in draft form or have not yet been proposed, leading to uncertainty about their scope and implementation.

**International Regulation**

In addition to regulations in the United States, the European Union and the PRC, we will be subject to a variety of other regulations governing clinical trials and commercial sales and distribution of our products

to the extent we choose to develop or sell any products outside of the United States, Europe or the PRC. The approval and reimbursement process varies from country to country and the time may be longer or shorter than that required to obtain FDA, EMA or NMPA approval. The requirements governing the conduct of clinical trials, product licensing, pricing and reimbursement vary greatly from country to country. In all cases the clinical trials must be conducted in accordance with cGCP requirements and the applicable regulatory requirements and the ethical principles having their origin in the Declaration of Helsinki.

#### **Anti-Corruption Laws**

The FCPA, the U.S. domestic bribery statute contained in 18 U.S.C. §201, the U.S. Travel Act, the USA PATRIOT Act, and possibly other state and national anti-bribery and anti-money laundering laws in countries in which we conduct activities, prohibit any U.S. individual or business from paying, offering or authorizing payment or offering of anything of value, directly or indirectly, to any foreign official, political party or candidate for the purpose of influencing any act or decision of the foreign entity in order to assist the individual or business in obtaining or retaining business. This could become relevant in the conduct of international clinical trials where the sites for such studies may be a government-owned hospital. The FCPA also obligates companies whose securities are listed in the United States to comply with accounting provisions requiring the company to maintain books and records that accurately and fairly reflect all transactions of the corporation, including international subsidiaries, and to devise and maintain an adequate system of internal accounting controls for international operations. Activities that violate the FCPA, even if they occur wholly outside the United States, can result in criminal and civil fines, imprisonment, disgorgement, oversight and debarment from government contracts.

In the European Union, interactions between pharmaceutical companies and physicians are governed by strict laws, regulations, industry self-regulation codes of conduct and physicians' codes of professional conduct both at the European Union level and in the individual European Union member states. The provision of benefits or advantages to physicians to induce or encourage the prescription, recommendation, endorsement, purchase, supply, order or use of medicinal products is prohibited in the European Union. The provision of benefits or advantages to physicians is also governed by the national anti-bribery laws of the European Union member states. Violation of these laws could result in substantial fines and imprisonment. Payments made to physicians in certain European Union member states also must be publicly disclosed. Moreover, agreements with physicians must often be the subject of prior notification and approval by the physician's employer, his/her regulatory professional organization, and/or the competent authorities of the individual European Union member states. These requirements are provided in the national laws, industry codes, or professional codes of conduct, applicable in the individual European Union member states. Failure to comply with these requirements could result in reputational risk, public reprimands, administrative penalties, fines or imprisonment.

## MANAGEMENT

## Directors and Executive Officers

The following table sets forth information regarding our directors and executive officers as of the date of this prospectus.

<u>Name</u>	<u>Age</u>	<u>Positions(s)</u>
Yu-Hsin Lin	44	Chief Executive Officer, Chairman of the Board of Directors*
Hao-Yuan Chuang	38	Chief Financial Officer, Director*
Nathan L. Mata	56	Chief Scientific Officer
Ching-Chen Chiu	52	Vice President of Clinical Operations
Wan-Shan Chen	36	Director*
Hung-Wei Chen	40	Director*
John M. Longo	53	Independent Director Nominee#
Ita Lu	45	Independent Director Nominee#
Gary C. Biddle	70	Independent Director Nominee#

\* This director was appointed by Lin BioScience, Inc. (Taiwan OTC: 6696), our ultimate controlling shareholder.

# Each of Dr. John M. Longo, Mr. Ita Lu and Prof. Gary C. Biddle has accepted appointment as a director, which will be immediately effective upon the declaration of effectiveness of our registration statement on Form F-1 by the SEC, of which this prospectus is a part.

The following is a biographical summary of the experience of our directors and executive officers.

*Dr. Yu-Hsin Lin*, aged 44, is our founder and has served as Director of our Company since we established the Company in March 2018 and the Chairman and the Chief Executive Officer of our Company since November 2021. Dr. Lin has also served as the chairman and the chief executive officer of Belite Bio Holdings Corp. (our wholly owned subsidiary incorporated in Delaware) since June 2016 and December 2017, respectively. From June 2016 to December 2017, Dr. Lin also served as the president of Belite Bio Holdings Corp. (our wholly owned subsidiary). Dr. Lin has served as director and chief executive officer of RBP4 Pty Ltd (our wholly owned subsidiary in Australia) since August 2018 and April 2021, respectively. Dr. Lin has served as director of Belite Bio (HK) Limited (our wholly owned subsidiary in Hong Kong) since June 2021, and the president of Belite Bio Holdings Corp. and Belite Bio, LLC (our wholly owned subsidiaries) since October 2021. Dr. Lin is primarily responsible for the overall management, strategic planning and corporate development of our Company. Dr. Lin is also the founder and has served as the director and the chairman and the chief executive officer of Lin BioScience, Inc. (Taiwan OTC: 6696), our ultimate controlling shareholder, since May 2016 and June 2016, respectively. From 2014 to 2016, Dr. Lin was the president and chief operating officer of CVie Therapeutics Limited. In 2014, Dr. Lin served as the general manager and medical director of ASLAN Pharmaceuticals (Nasdaq: ASLN). From 2010 to 2014, Dr. Lin served as the senior medical director of OBI Pharma, Inc. (TPEX: 4174). From 2008 to 2010, Dr. Lin worked as the medical instructor of Faculty of Medicine, University of Sydney. Dr. Lin received his master's degree in medicine from University of Sydney where he specialized in multidisciplinary medicine and surgery. Dr. Lin received his PhD in medicine from University of Sydney where he specialized in neurology & immunology. Dr. Lin also received a Specialist Certificate in Clinical Neuroscience from University of Melbourne and a Cancer Therapeutics & Research Certificate from Harvard Medical School. Dr. Lin further received his master's degree in business and administration from Columbia University, London Business School and HK University.

*Mr. Hao-Yuan Chuang*, aged 38, has served as the Chief Financial Officer of our Company since November 2020 and Director of our Company since November 2021. Mr. Chuang has also served as the director of Belite Bio (HK) Limited (our wholly owned subsidiary in Hong Kong) since June 2021 and as supervisor of Belite Bio (Shanghai) Limited (our wholly owned subsidiary in China) since August 2021. He is primarily responsible for leading our Company's finance, accounting, investor relations, and capital markets strategy and activities. Mr. Chuang is also the chief financial officer and a director of Lin BioScience,

Inc. (Taiwan OTC: 6696), our ultimate controlling shareholder, since August 2018 and September 2018, respectively. From December 2017 to August 2018, Mr. Chuang worked as the finance and accounting director of Lin BioScience, Inc. (Taiwan OTC: 6696), our ultimate controlling shareholder. From 2016 to 2017, Mr. Chuang served as the investment director of Suning International Limited. From 2015 to 2016, Mr. Chuang worked as the portfolio manager of The People's Insurance Company (Group) of China Limited (HKG: 1339). From 2013 to 2015, Mr. Chuang was the senior manager of Wanda Hotel Development Company Limited (HKG: 0169). From 2010 to 2013, Mr. Chuang was the manager of corporate finance of CITIC Securities International Company Limited. From 2006 to 2010, Mr. Chuang was the senior associate of Chii Ying Co., Ltd. Mr. Chuang received his bachelor's degree in economics and minor in business administration from National Taiwan University. He received his master's degree in business & administration from Columbia University, London Business School and HK University. Mr. Chuang is also a chartered financial analyst and financial risk manager.

*Dr. Nathan L. Mata*, aged 56, has served as the Chief Scientific Officer of our Company since November 2021. Dr. Mata has also served as the chief scientific officer of Belite Bio, LLC (our wholly owned subsidiary incorporated in Delaware) since August 2021. Dr. Mata is primarily responsible for overseeing our Company's scientific and clinical activities, including basic and applied research projects and clinical programs, as well as the development of new processes, technologies or products. From 2019 to 2021, Dr. Mata was the principal consultant of clinical development sector of Halloran Consulting Group. From 2018 to 2019, Dr. Mata was the clinical research & operations consultant of Kubota Vision Inc. (formerly Acucela Inc.). From 2015 to 2018, Dr. Mata worked for Trethera Corporation. He acted as the chief operating officer and director of R&D section from 2015 to 2017, and then worked as clinical research & operations consultant from 2017 to 2018. From 2012 to 2015, Dr. Mata was the principal clinical research scientist of Acucela Inc. From 2010 to 2012, Dr. Mata co-founded and served as the chief scientific officer of Revision Therapeutics. From 2006 to 2008, Dr. Mata served as the vice president of R&D of Sirion Therapeutics. He also served as the chief scientific officer and senior vice president of R&D sector in the same company from 2008 to 2010. From 2004 to 2006, Dr. Mata co-founded and served as a director of SYTERA, INC., which was the research and development unit of Sirion Therapeutics. Dr. Mata received his bachelor's degree in biology, master's degree in biochemistry and PhD in neurobiology from University of Texas at San Antonio.

*Ms. Ching-Chen Chiu*, aged 52, has served as the Vice President of Clinical Operations of our Company since November 2021 and as executive officer and legal representative of Belite Bio (Shanghai) Limited (our wholly owned subsidiary in China) since January 2022. She is primarily responsible for leading our global clinical operations. Prior to joining our Company, Ms. Chiu has over 15 years' experience leading global clinical CRO companies where she served as board and managing director of CMIC Asia Pacific and executive director of EPS International Co. Ltd. Ms. Chiu's extensive clinical operations and research experience includes managing over hundred clinical studies in multiple therapeutic areas for both CRO's and global pharmaceutical companies while she was at Pfizer and Bayer. Ms. Chiu received her bachelor's degree in science from Taipei Medical University, and master's degree in science (medical information) from University of Warwick, UK.

*Ms. Wan-Shan Chen*, aged 36, has served as a Director our Company since November 2021. She has also served as associate finance director of Lin BioScience, Inc. (Taiwan OTC: 6696), our ultimate controlling shareholder, since January 2019. From November 2017 to January 2019, Ms. Chen worked as the senior finance manager of Lin BioScience, Inc. (Taiwan OTC: 6696), our ultimate controlling shareholder. From June 2016 to October 2017, Ms. Chen worked as the finance manager of Lin BioScience, Inc. (Taiwan OTC: 6696), our ultimate controlling shareholder. From 2014 to 2016, Ms. Chen was finance manager of CVie Therapeutics Limited. From 2009 to 2014, Ms. Chen worked as assistant manager of audit department of Deloitte Taiwan. Ms. Chen received her master's degree in accounting from National Taipei University. Ms. Chen is also a certified public accountant in Taiwan.

*Ms. Hung-Wei Chen*, aged 40, has served as a Director of our Company since November 2021. She has also served as the director and the chief operating officer of Lin BioScience, Inc. (Taiwan OTC: 6696), our ultimate controlling shareholder, since July 2021 and August 2018, respectively. From July 2016 to August 2018, Ms. Chen worked as the clinical operations director of Lin BioScience, Inc. (Taiwan OTC: 6696), our ultimate controlling shareholder. From 2015 to 2016, Ms. Chen was associate clinical development



director of CVie Therapeutics Limited. From 2012 to 2014, Ms. Chen was senior clinical operations manager of OBI Pharma, Inc. (TPEX: 4174). From 2005 to 2012, Ms. Chen served as project manager, study manager, clinical operations manager, clinical quality manager and clinical research associate in Pfizer Taiwan. Ms. Chen received her master's degree in science (medicinal chemistry) from National Taiwan University. Ms. Chen is also a certified pharmacist.

*Dr. John M. Longo*, aged 53, has served as the independent Director of our Company since 2022. Dr. Longo has also served as a faculty member at Rutgers Business School on a full-time or part-time basis since June 1993, where he is currently professor of practice in its finance & economics department. Dr. Longo has also been a visiting professor of finance at Global EMBA -Asia, the joint EMBA program of Columbia Business School, London Business School, and the University of Hong Kong since 2016. Dr. Longo served as chief investment officer for two wealth management firms since October 2002, first with the MDE Group and then with Beacon Trust after its acquisition of the MDE Group in 2015. Dr. Longo has also served as the president of Cliff House Capital Management and its predecessor, Cyborg Capital Management, since March 2000. Cliff House Capital Management is primarily used as a holding company for Dr. Longo's non-academic activities. Dr. Longo was previously a vice president in the management science group at Merrill Lynch & Co., Inc., having worked as a quantitative investment analyst for the firm from 1997 to 2000. Dr. Longo received his bachelor's degree in economics and computer science from Rutgers College in 1991. Dr. Longo further received his PhD and master of business administration in finance from Rutgers Business School in 1995. Dr. Longo has been a CFA Charter holder since 1998.

*Mr. Ita Lu*, aged 45, has served as the independent Director of our Company since 2022. Mr. Lu has also served as the managing partner of Taiwan Capital since May 2018. From 2017 to 2018, Mr. Lu served as the vice president of business development and investor relations of Etana Biotech. From 2009 to 2017, Mr. Lu served as the head of greater China healthcare of KGI Securities. From 2008 to 2009, Mr. Lu served as the equity research analyst of greater China healthcare of Yuanta Research. From 2006 to 2008, Mr. Lu served as the investment manager of China Investment Development Corp. (SEHK: 204). From 2001 to 2006, Mr. Lu served as the investment manager of China Development Industrial Bank. From 1999 to 2001, Mr. Lu served as the research associate of MedImmune, Inc. Mr. Lu received his bachelor's degree in cell structural biology from University of Illinois at Urbana-Champaign and further received his master's degree in biotechnology from Johns Hopkins University. Mr. Lu is also a certified senior securities specialist in Taiwan. Mr. Lu also passed Hong Kong Securities Institute Licensing Examination for Securities and Futures Intermediaries Paper 1.

*Prof. Gary C. Biddle*, aged 70, has served as the independent Director of our Company since 2022. He is professor of financial accounting at University of Melbourne and visiting professor at Columbia University Business School, University of Hong Kong (HKU), and London Business School. Professor Biddle earned his MBA and PhD degrees at University of Chicago. He previously served as professor at University of Chicago, University of Washington, Hong Kong University of Science and Technology (HKUST) and at HKU. In academic leadership, Professor Biddle served as Dean and Chair Professor at HKU, and as Academic Dean, Department Head, Council member, Court member, Senate member, and Chair Professor at HKUST. He co-created the EMBA-Global Asia program and taught the first class and decade of the Kellogg-HKUST EMBA program, both recently ranked #1 in the world by *Financial Times* and *QS*. Professionally, he is a member of the AICPA, Australian Institute of Company Directors, CPA Australia, and HKICPA. Professor Biddle has served as editor and editorial board member of premier academic journals and as American Accounting Association Executive Board member, Vice-President, and President-Elect nominee, on the Accounting Hall of Fame Selection Committee, Financial Reporting Review Panel of the Financial Reporting Council of Hong Kong, HKICPA Council, Accreditation and Financial Reporting Standards Committees of HKICPA, and Hong Kong Institute of Directors Training Committee. Professor Biddle is a leading expert in financial and management accounting (teaching both), value creation, economic forecasting, corporate governance, and performance metrics, including EVA<sup>®</sup>. His research appears in leading academic journals and in the financial press including *CNBC*, *CNN*, *SCMP*, *The Economist*, and *The Wall Street Journal*. He has nearly 9,400 Google Scholar citations has won 30 teaching honours. He also proudly serves as Non-Executive Director of Kingdee International Software, as Independent Non-Executive Director and Audit and Risk Committee Chair of Shui On Land Limited, as Independent Non-Executive Director and Audit and Finance Committee Chair of Real Pet Food Company

(New Hope Group), and he previously served as Remuneration Committee Chair of Chinachem Group. He also runs charity 10k races.

#### **Board of Directors**

Our board of directors will consist of seven (7) directors upon the SEC's declaration of effectiveness of our registration statement on Form F-1 of which this prospectus is a part. A director is not required to hold any shares in our company by way of qualification. A director who is in any way, whether directly or indirectly, interested in a contract or transaction or proposed contract or transaction with our company is required to declare the nature of his interest at a meeting of our directors. Subject to the Nasdaq Stock Market rules and disqualification by the chairman of the relevant board meeting, a director may vote in respect of any contract or transaction or proposed contract or transaction notwithstanding that he may be interested therein, and if he does so his vote shall be counted and he shall be counted in the quorum at any meeting of our directors at which any such contract or transaction or proposed contract or transaction is considered, provided (i) such director, if his or her interest in such contract or arrangement is material, has declared the nature of his or her interest at the earliest meeting of the board at which it is practicable for him or her to do so, either specifically or by way of a general notice and (ii) if such contract or arrangement is a transaction with a related party, such transaction has been approved by the audit committee. Our directors may exercise all the powers of our company to raise or borrow money and to mortgage or charge its undertaking, property and assets (present and future) and uncalled capital or any part thereof, to issue debentures, debenture stock, bonds and other securities, whether outright or as collateral security for any debt, liability or obligation of our company or of any third party.

#### **Committees of the Board of Directors**

We will establish three committees under the board of directors immediately upon the effectiveness of our registration statement on Form F-1, of which this prospectus is a part: an audit committee, a compensation committee and a nominating and corporate governance committee. We will adopt a charter for each of the three committees. Each committee's members and functions are described below.

*Audit Committee.* Our audit committee will consist of John M. Longo, Ita Lu and Gary C. Biddle. John M. Longo will be the chairman of our audit committee. We have determined that John M. Longo, Ita Lu and Gary C. Biddle satisfy the "independence" requirements of Rule 5605(a)(2) of the Listing Rules of the Nasdaq Stock Market and Rule 10A-3 under the Exchange Act. We have determined that each of John M. Longo and Gary C. Biddle qualifies as an "audit committee financial expert." The audit committee will oversee our accounting and financial reporting processes and the audits of the financial statements of our company. The audit committee will be responsible for, among other things:

- appointing the independent auditors and pre-approving all auditing and non-auditing services permitted to be performed by the independent auditors;
- reviewing with the independent auditors any audit problems or difficulties and management's response;
- discussing the annual audited financial statements with management and the independent auditors;
- reviewing the adequacy and effectiveness of our accounting and internal control policies and procedures and any steps taken to monitor and control major financial risk exposures;
- reviewing and approving all proposed related party transactions;
- meeting separately and periodically with management and the independent auditors; and
- monitoring compliance with our code of business conduct and ethics, including reviewing the adequacy and effectiveness of our procedures to ensure proper compliance.

*Compensation Committee.* Our compensation committee will consist of Hao-Yuan Chuang, Ita Lu and John M. Longo. Ita Lu will be the chairman of our compensation committee. We have determined that Ita Lu and John M. Longo satisfy the "independence" requirements of Rule 5605(a)(2) of the Listing Rules of the Nasdaq Stock Market. The compensation committee will assist the board in reviewing and approving the compensation structure, including all forms of compensation, relating to our directors and

executive officers. Our chief executive officer may not be present at any committee meeting during which his compensation is deliberated. The compensation committee will be responsible for, among other things:

- reviewing and approving, or recommending to the board for its approval, the compensation for our chief executive officer and other executive officers;
- reviewing and recommending to the board for determination with respect to the compensation of our non-employee directors;
- reviewing periodically and approving any incentive compensation or equity plans, programs or similar arrangements; and
- selecting compensation consultant, legal counsel or other adviser only after taking into consideration all factors relevant to that person's independence from management.

*Nominating and Corporate Governance Committee.* Our nominating and corporate governance committee will consist of Yu-Hsin Lin, John M. Longo and Gary C. Biddle. Gary C. Biddle will be the chairman of our nominating and corporate governance committee. John M. Longo and Gary C. Biddle satisfy the "independence" requirements of Rule 5605(a)(2) of the Listing Rules of the Nasdaq Stock Market. The nominating and corporate governance committee will assist the board of directors in selecting individuals qualified to become our directors and in determining the composition of the board and its committees. The nominating and corporate governance committee will be responsible for, among other things:

- selecting and recommending to the board nominees for election by the shareholders or appointment by the board;
- reviewing annually with the board the current composition of the board with regards to characteristics such as independence, knowledge, skills, experience and diversity;
- making recommendations on the frequency and structure of board meetings and monitoring the functioning of the committees of the board; and
- advising the board periodically with regards to significant developments in the law and practice of corporate governance as well as our compliance with applicable laws and regulations, and making recommendations to the board on all matters of corporate governance and on any remedial action to be taken.

#### **Duties of Directors**

Under Cayman Islands law, our directors owe fiduciary duties to our company, including a duty of loyalty, a duty to act honestly and a duty to act in what they consider in good faith to be in our best interests. Our directors must also exercise their powers only for a proper purpose. Our directors also owe to our company a duty to act with skill and care. It was previously considered that a director need not exhibit in the performance of his duties a greater degree of skill than may reasonably be expected from a person of his knowledge and experience. However, English and Commonwealth Courts have moved toward an objective standard with regard to the required skill and care and these authorities are likely to be followed in the Cayman Islands. In fulfilling their duty of care to us, our directors must ensure compliance with our memorandum and articles of association, as amended and restated from time to time, and the class rights vested thereunder in the holders of the shares. In certain limited exceptional circumstances, a shareholder may have the right to seek damages in our name if a duty owed by our directors is breached.

Our board of directors has all the powers necessary for managing, and for directing and supervising, our business affairs. The functions and powers of our board of directors include, among others:

- convening shareholders' annual and extraordinary general meetings and reporting its work to shareholders at such meetings;
- declaring dividends and distributions;
- appointing officers and determining the term of office of the officers;
- exercising the borrowing powers of our company and mortgaging the property of our company; and

- approving the transfer of shares in our company, including the registration of such shares in our share register.

#### **Terms of Directors and Officers**

Our directors may be elected by an ordinary resolution of our shareholders. Alternatively, our board of directors may, by the affirmative vote of a simple majority of the directors present and voting at a board meeting appoint any person as a director to fill a casual vacancy on our board or as an addition to the existing board. Our directors are not automatically subject to a term of office and hold office until such time as they are removed from office by an ordinary resolution of our shareholders. In addition, a director will cease to be a director if he (i) becomes bankrupt or makes any arrangement or composition with his creditors; (ii) dies or is found to be or becomes of unsound mind; (iii) resigns his office by notice in writing; (iv) is prohibited by any applicable Law or Nasdaq Stock Market rules from being a director; (v) without special leave of absence from our board, is absent from meetings of our board for three consecutive meetings and our board resolves that his office be vacated; or (vi) is removed from office pursuant to any other provision of our articles of association.

Our officers are appointed by and serve at the discretion of the board of directors, and may be removed by our board of directors.

#### **Employment Agreements and Indemnification Agreements**

We have entered into employment agreements with each of our executive officers. Under these agreements, the employment of our executive officers who are located at San Diego is governed by the laws of the State of California and is at-will and for no specific period of time. We may terminate employment for cause with 3-month notice, for certain acts of the executive officer, such as personal dishonesty, conviction of a crime, willful act which constitutes misconduct and is materially injurious to our Company, or continued violations of the executive officer's obligations to our Company. We may also terminate an executive officer's employment without cause and our executive officers may resign at any time, subject, in each case, to 3-month prior written notice. The employment of our executive officers who are located at Taiwan is governed by the laws of Taiwan and is for no specific period of time, which may be terminated at any time by mutual agreement or by either the executive officer or the Company pursuant to the applicable law.

Each executive officer has agreed to hold, both during and after the termination or expiry of his or her employment agreement, in strictest confidence, and not to use, except for the benefit of our Company, or to disclose to any person, firm or corporation without written authorization of an officer of our Company, any confidential information, except under a non-disclosure agreement duly authorized and executed by our Company. The executive officers have also agreed to disclose in confidence to us all inventions, designs and trade secrets which they conceive, develop or reduce to practice during the executive officer's employment with us and to assign all right, title and interest in them to us, and assist us in obtaining and enforcing patents, copyrights and other legal rights for these inventions, designs and trade secrets.

In addition, each executive officer has agreed to be bound by non-competition and non-solicitation restrictions during the term of his or her employment and non-solicitation restrictions for one year following the last date of employment. Specifically, each executive officer has agreed not to (i) either directly or indirectly solicit, induce, recruit or encourage any of our employees to leave their employment, or attempt to solicit, induce, recruit, or encourage any of our employees to leave their employment; or (ii) directly or indirectly through any other person, use any of our trade secrets to influence or attempt to influence customers, vendors, suppliers, licensors, lessors, joint venturers, associates, consultants, agents, or partners of our Company to divert their business away from us.

We have also entered into indemnification agreements with each of our directors and executive officers. Under these agreements, we agree to indemnify our directors and executive officers against certain liabilities and expenses incurred by such persons in connection with claims made by reason of their being a director or officer of our company.

#### **Compensation of Directors and Executive Officers**

For the fiscal year ended December 31, 2021, we paid an aggregate of approximately US\$0.17 million in cash to our directors and executive officers and did not grant any options to purchase our ordinary shares

to our directors and executive officers. We have not set aside or accrued any amount to provide pension, retirement or other similar benefits to our directors and executive officers. Our PRC, U.S. and Australian subsidiaries are required by law to make contributions equal to certain percentages of each employee's salary for his or her pension insurance, medical insurance, unemployment insurance and other statutory benefits and a housing provident fund. For share incentive grants to our directors and executive officers, see "— Share Incentive Plans."

## Share Incentive Plans

### *2020 Share Incentive Plan*

In December 2019, we adopted the Belite Bio, Inc Share Incentive Plan, or the 2019 Share Incentive Plan, which was later superseded and replaced by the Belite Bio, Inc Amended and Restated Share Incentive Plan, or the 2020 Share Incentive Plan, in December 2020. The terms of the 2019 Share Incentive Plan and the 2020 Share Incentive Plan are substantially the same other than the maximum aggregate number of shares we may issue under the respective plan.

The purpose of the 2020 Share Incentive Plan is to attract and retain the best available personnel, provide additional incentives to directors, employees and consultants, and promote the success of our business. The maximum aggregate number of ordinary shares that may be issued under the 2020 Share Incentive Plan is 4,165,310 ordinary shares. As of the date of this prospectus, options to purchase a total of 1,982,561 ordinary shares are outstanding under the 2020 Share Incentive Plan.

The following paragraphs summarize the principal terms of the 2020 Share Incentive Plan.

*Type of Awards.* The 2020 Share Incentive Plan permits the awards of options, share appreciation right, share bonuses, performance shares, share units, phantom shares, dividend equivalents, or similar rights to purchase or acquire ordinary shares or any similar securities with a value derived from the value of or related to the ordinary shares and/or returns thereon.

*Plan Administration.* The 2020 Share Incentive Plan shall be administered by our board of directors or one or more committees appointed by the board of directors or another committee (within its delegated authority), the Plan Administrator.

*Award Agreement.* Each award under the 2020 Share Incentive Plan shall be evidenced by an award agreement in the form approved by the plan administrators. The terms of the award agreements will be determined by the plan administrators and consistent with the terms of the 2020 Share Incentive Plan.

*Eligibility.* The plan administrators may decide that an award under the 2020 Share Incentive Plan be granted to any employee, officer or director of the Company or its affiliates, or that it be granted to any consultant or adviser who provides services to the Company or its affiliates.

*Vesting Schedule.* In general, the plan administrator determines the vesting schedule, which is specified in the relevant award agreement.

*Exercise Price.* The plan administrator determines the exercise price for each award, which is stated in the award agreement.

*Term of the Awards.* Options that are vested and exercisable will terminate if they are not exercised prior to the time as the plan administrator determines at the time of grant. However, the maximum exercisable term is ten years from the date of a grant.

*Transfer Restrictions.* With a few exceptions, no right of interest of a participant in any award may be subject in any manner to sale, transfer, anticipation, alienation, assignment, pledge, encumbrance or charge. This restriction does not apply to (i) transfers to our company, (ii) transfers by gift or domestic relations order to one or more family members, (iii) the designation of a beneficiary to receive benefits if a participant dies or transfers by will, (iv) permitted transfers or exercises on behalf of a participant by the participant's duly authorized legal representative if the participant has suffered a disability.

*Termination and Amendment.* The board of directors may, at any time, terminate or, from time to time, amend, modify or suspend the 2020 Share Incentive Plan, in whole or in part. No awards may be granted during any period that the board of directors suspends the 2020 Share Incentive Plan. To the extent then required by applicable law or listing agency, any amendment to the 2020 Share Incentive Plan may be subject to shareholder approval. Unless earlier terminated by the board of directors, the 2020 Share Incentive Plan will terminate at the close of business on the day before the 10th anniversary of the date the board of directors approved the 2020 Share Incentive Plan.

#### **2022 Performance Incentive Plan**

In connection with this offering, we intend to adopt a 2022 Performance Incentive Plan.

The following table summarizes, as of the date of this prospectus, the number of ordinary shares underlying outstanding options that we granted to our directors and executive officers.

Name	Ordinary Shares Underlying Options	Exercise Price (US\$/Share)	Date of Grant	Date of Expiration
Yu-Hsin Lin	827,814	\$0.4386	December 23, 2020	December 22, 2030
Hao-Yuan Chuang	579,471	\$0.4386	December 23, 2020	December 22, 2030
Nathan L. Mata	—	—	—	—
Ching-Chen Chiu	—	—	—	—
Wan-Shan Chen	*	\$0.4386	December 23, 2020	December 22, 2030
Hung-Wei Chen	*	\$0.4386	December 23, 2020	December 22, 2030
<b>All directors and executive officers as a group</b>	1,494,775			

Note:

\* Less than 1% of our total ordinary shares on an as-converted basis outstanding as of the date of this prospectus.

As of the date of this prospectus, our award holders other than our directors and officers as a group held options to purchase 487,786 ordinary shares, with exercise prices ranging from US\$0.1191 per share to US\$4.2254 per share.

## PRINCIPAL SHAREHOLDERS

Except as specifically noted, the following table sets forth information with respect to the beneficial ownership of our ordinary shares on an as-converted basis as of the date of this prospectus by:

- each of our directors and executive officers; and
- each person known to us to own beneficially more than 5% of our ordinary shares

The calculations in the table below are based on 18,095,317 ordinary shares on an as-converted basis outstanding as of the date of this prospectus, and ordinary shares outstanding immediately after the completion of this offering. Each holder of ordinary shares is entitled to one vote per share on all matters submitted to them for a vote.

Beneficial ownership is determined in accordance with the rules and regulations of the SEC. In computing the number of shares beneficially owned by a person and the percentage ownership of that person, we have included shares that the person has the right to acquire within 60 days, including through the exercise of any option, warrant or other right or the conversion of any other security. These shares, however, are not included in the computation of the percentage ownership of any other person.

	Ordinary Shares Beneficially Owned Prior to This Offering		Ordinary Shares Beneficially Owned After This Offering		
	Ordinary Shares	% of Beneficial Ownership†	Ordinary Shares	% of Beneficial Ownership	% of aggregate voting power††
<b>Directors and Executive Officers**:</b>					
Yu-Hsin Lin <sup>(1)</sup>	2,463,015	13.61%			
Hao-Yuan Chuang <sup>(2)</sup>	529,193	2.92%			
Nathan L. Mata	—	—			
Ching-Chen Chiu	*	*			
Wan-Shan Chen <sup>(3)</sup>	*	*			
Hung-Wei Chen <sup>(4)</sup>	193,526	1.07%			
John M. Longo (independent director nominee).	—	—			
Ita Lu (independent director nominee) <sup>(5)</sup> .	—	—			
Gary C. Biddle (independent director nominee)	—	—			
<b>Principal Shareholders:</b>					
Lin Bioscience International Ltd <sup>(6)</sup> .	13,928,597	76.97%			

Notes:

- \* Less than 1% of our total ordinary shares on an as-converted basis outstanding as of the date of this prospectus.
- \*\* The business address of our directors and executive officers, except for Nathan L. Mata, John M. Longo and Ita Lu is Room 2972, 29F., No. 68, Sec. 5, Zhongxiao E. Rd., Xinyi Dist., Taipei City 110, Taiwan; the business address of Nathan L. Mata is 5820 Oberlin Drive, Suite 101, San Diego, CA 92121; the business address of John M. Longo is 100 Rockefeller Road, Piscataway, NJ 08854; the business address of Ita Lu is 5F-7 No. 1 Xinyi Road Section 2, Taipei Taiwan; the business address of Gary C. Biddle is Level 8, 198 Berkeley Street, Carlton, VIC 3010, Australia.
- † For each person and group included in this column, percentage ownership is calculated by dividing the number of shares beneficially owned by such person or group by the sum of the total number of shares outstanding and the number of shares such person or group has the right to acquire upon exercise of option, warrant or other right within 60 days after the date of this prospectus. The total number of ordinary shares outstanding as of the date of this prospectus on an as-converted basis is 18,095,317. The

total number of ordinary shares outstanding after the completion of this offering will be including ordinary shares to be sold by us in this offering in the form of ADSs, assuming that the underwriters do not exercise their option to purchase additional ADSs.

†† For each person and group included in this column, percentage of voting power is calculated by dividing the voting power beneficially owned by such person or group by the voting power of all of our ordinary shares as a single class. Our ordinary shares vote together as a single class on all matters submitted to a vote of our shareholders, except as may otherwise be required by law.

- (1) Represents 731,728 ordinary shares directly held by Yu-Hsin Lin, and 1,731,287 shares indirectly held by Yu-Hsin Lin through Lin Bioscience International Ltd. The exercise price of the outstanding options granted to Yu-Hsin Lin is US\$0.4386 per share.
- (2) Represents 512,210 ordinary shares directly held by Hao-Yuan Chuang, and 16,983 shares indirectly held by Hao-Yuan Chuang through Lin Bioscience International Ltd. The exercise price of the outstanding options granted to Hao-Yuan Chuang is US\$0.4386 per share.
- (3) The exercise price of the outstanding options granted to Wan-Shan Chen is US\$0.4386 per share.
- (4) Represents 58,435 ordinary shares directly held by Hung-Wei Chen, and 135,091 shares indirectly held by Hung-Wei Chen through Lin Bioscience International Ltd. The exercise price of the outstanding options granted to Hung-Wei Chen is US\$0.4386 per share.
- (5) The remuneration for Mr. Lu's service as our director is comprised of cash payment and option grant. The cash portion of such remuneration will be deferred and will only be paid to Mr. Lu after his employment relationship with Taiwania Capital is terminated. In addition, the option portion of such remuneration will only be granted to Mr. Lu under our 2022 Performance Incentive Plan after his employment relationship with Taiwania Capital terminates.
- (6) Represents 8,840,321 ordinary shares and 5,088,276 Series B Preferred Shares directly held by Lin Bioscience International Ltd.

As of the date of this prospectus, none of our ordinary shares are held by record holders in the United States. We are not aware of any arrangement that may, at a subsequent date, result in a change of control of our company.



## RELATED PARTY TRANSACTIONS

### Private Placements

See “Description of Share Capital — History of Securities Issuances.”

### Shareholders Agreement

See “Description of Share Capital — Shareholders Agreement.”

### Employment Agreements and Indemnification Agreements

See “Management — Employment Agreements and Indemnification Agreements.”

### Share Incentive Plans

See “Management — Share Incentive Plans.”

### Other Transactions with Related Parties

#### LBS-007

*2018 LBS-007 Co-Development Agreement.* On February 27, 2018, Lin BioScience, Inc., our ultimate controlling shareholder, entered into a co-development agreement (the “**2018 LBS-007 Co-Development Agreement**”) with Belite Bio Holdings Corp. (the direct subsidiary of Lin BioScience, Inc. at that time, and now our wholly owned subsidiary), pursuant to which (i) both parties agreed to jointly perform certain new drug development project(s) for the development of LBS-007 from February 27, 2018 to February 27, 2023; (ii) each party agreed to bear its own costs for the performance of such project; (iii) if the project becomes commercialized, 10% of the profit derived from such commercialization will be shared with Belite Bio Holdings Corp. provided that a written agreement is entered into by and between the parties and a third-party licensee; and (iv) Belite Bio Holdings Corp. acknowledged and agreed that Lin BioScience, Inc. was the sole and exclusive owner of all intellectual property rights that Belite Bio Holdings Corp. directly or indirectly managed, developed or assisted in the performance of such project. Lin BioScience, Inc. and Belite Bio Holdings Corp. entered into a deed of termination which terminated the 2018 LBS-007 Co-Development Agreement with effect from January 20, 2020 and the parties agreed to waive all obligations due under the agreement. We have not received any consideration owing to the above agreement.

#### LBS-021 and LBS-031

*2018 LBS-021/031 R&D Services Agreement.* On January 1, 2018, Lin BioScience, Inc., our ultimate controlling shareholder, entered into a research and development services agreement (the “**2018 LBS-021/031 R&D Agreement**”) with our wholly owned subsidiaries, Belite Bio Holdings Corp. and Belite Bio, LLC (collectively, the “**Service Provider**”), pursuant to which the Service Provider agreed to (i) perform certain research and development services for Lin BioScience, Inc. for the development of LBS-021 and LBS-031 from January 1, 2018 to December 31, 2018, and (ii) assign the ownership of the deliverables to Lin BioScience, Inc. and acknowledged and agreed that Lin BioScience, Inc. is the sole and exclusive owner of all intellectual property that the Service Provider directly or indirectly managed, developed or assisted in the performance of the services. The total consideration Belite Bio Holdings Corp. and Belite Bio, LLC received for such development services, assignment and licensing was nil and \$85,821.17, respectively.

*2019 LBS-021/031 R&D Services Agreement.* On January 1, 2019, Lin BioScience, Inc., our ultimate controlling shareholder, entered into a research and development services agreement (the “**2019 LBS-021/031 R&D Agreement**”) with our wholly owned subsidiaries, Belite Bio Holdings Corp. and Belite Bio, LLC (collectively, the “**Service Provider**”), pursuant to which the Service Provider agreed to (i) perform certain research and development services for Lin BioScience, Inc. for the development of LBS-021 and LBS-031 from January 1, 2019 to December 31, 2019, and (ii) assign the ownership of the deliverables to Lin BioScience, Inc. and acknowledged and agreed that Lin BioScience, Inc. is the sole and exclusive owner of all intellectual property that the Service Provider directly or indirectly managed, developed or assisted in the performance of the services. The total consideration Belite Bio Holdings Corp. and Belite Bio, LLC received for such development services, assignment and licensing was nil and \$25,900.75, respectively.

***LBS-009***

*2018 LBS-009 R&D Services Agreement.* On July 1, 2018, we entered into a research and development services agreement (the “**2018 LBS-009 R&D Agreement**”) with Lin BioScience, Inc., our ultimate controlling shareholder, and Belite Bio Holdings Corp. and Belite Bio, LLC, (our wholly owned subsidiaries) (collectively, the “**Service Provider**”), pursuant to which (i) the Service Provider agreed to provide certain new drug development services for pipeline LBS-009 to us from July 1, 2018 to June 30, 2019, including sample collection for RBP4 analysis and project management; (ii) the Service Provider acknowledged that we are the sole and exclusive owner of all intellectual property rights that they directly or indirectly managed, developed or assisted in the performance of the services; and (iii) we agreed to pay service fees to the Service Provider in an amount equal to 110% percent of actual costs for its performance of such development services and to reimburse the actual expenses for transportation, travel and lodging for the performance of such development services. The total consideration we paid for such development services, assignment and licensing was nil to Lin BioScience, Inc., nil to Belite Bio Holdings Corp. and \$39,408.87 to Belite Bio, LLC.

*2019 LBS-009 R&D Services Agreement.* On July 1, 2019, we entered into a research and development services agreement (the “**2019 LBS-009 R&D Agreement**”) with Lin BioScience, Inc. (our ultimate controlling shareholder), Belite Bio Holdings Corp. and Belite Bio, LLC (our wholly owned subsidiaries) (collectively, the “**Service Provider**”), pursuant to which (i) the Service Provider agreed to provide certain new drug development services for pipeline LBS-009 to us from July 1, 2019 to June 30, 2020, including sample collection for RBP4 analysis and project management; (ii) the Service Provider acknowledged that we are the sole and exclusive owner of all intellectual property rights that they directly or indirectly managed, developed or assisted in the performance of the services; and (iii) we agreed to pay service fees to the Service Provider in an amount equal to 110% percent of actual costs for its performance of such development services and to reimburse the actual expenses for transportation, travel and lodging for the performance of such development services. The total consideration we paid for such development services, assignment and licensing was nil to Lin BioScience, Inc., nil to Belite Bio Holdings Corp. and \$3,280.02 to Belite Bio, LLC.

*2020 LBS-009 R&D Services Agreement.* On July 1, 2020, we entered into a research and development services agreement (the “**2020 LBS-009 R&D Agreement**”) with Lin BioScience, Inc. (our ultimate controlling shareholder), Belite Bio Holdings Corp. and Belite Bio, LLC (our wholly owned subsidiaries) (collectively, the “**Service Provider**”), pursuant to which (i) the Service Provider agreed to provide preclinical studies for pipeline LBS-009 to us from July 1, 2020 to June 30, 2021; (ii) the Service Provider acknowledged and agreed that we are the sole and exclusive owner of all intellectual property rights that they directly or indirectly managed, developed or assisted in the performance of the services; and (iii) we agreed to pay service fees to the Service Provider in an amount equal to 110% percent of actual costs for its performance of such development services and to reimburse the actual expenses for transportation, travel and lodging for the performance of such development services. The total consideration we paid for such development services was nil to Lin BioScience, Inc., nil to Belite Bio Holdings Corp. and nil to Belite Bio, LLC.

**LBS-008**

**2018 LBS-008 R&D Services Agreement.** On July 1, 2018, we entered into a research and development services agreement (the “**2018 LBS-008 R&D Agreement**”) with Lin BioScience, Inc. (our ultimate controlling shareholder), pursuant to which (i) our ultimate controlling shareholder agreed to provide certain new drug development services for pipeline LBS-008 to us from July 1, 2018 to June 30, 2019; (ii) our ultimate controlling shareholder acknowledged and agreed that we are the sole and exclusive owner of all intellectual property rights that our ultimate controlling shareholder directly or indirectly managed, developed or assisted in the performance of the services; and (iii) we agreed to pay service fees equal to 110% percent of actual costs for our ultimate controlling shareholder’s performance of such development services and to reimburse the actual expenses for transportation, travel and lodging for the performance of such development services. For such development services, the total consideration paid by us was nil to Lin BioScience, Inc.

**2019 LBS-008 R&D Services Agreement.** On July 1, 2019, we entered into a research and development services agreement (the “**2019 LBS-008 R&D Agreement**”) with Lin BioScience, Inc. (our ultimate controlling shareholder), pursuant to which (i) our ultimate controlling shareholder agreed to provide certain new drug development services for pipeline LBS-008 to us from July 1, 2019 to June 30, 2020; (ii) our ultimate controlling shareholder acknowledged and agreed that we are the sole and exclusive owner of all intellectual property rights that our ultimate controlling shareholder directly or indirectly managed, developed or assisted in the performance of the services; and (iii) we agreed to pay service fees equal to 110% percent of actual costs for our ultimate controlling shareholder’s performance of such development services and to reimburse the actual expenses for transportation, travel and lodging for the performance of such development services. On January 30, 2020, we entered into the first amendment to 2019 LBS-008 R&D Agreement with Lin BioScience, Inc., pursuant to which our ultimate controlling shareholder agreed to provide certain new drug development services and finance and accounting services. For such development and finance services, the total consideration paid by us was \$56,747.86 to Lin BioScience, Inc.

**2020 LBS-008 R&D Services Agreement.** On July 1, 2020, we entered into a research and development services agreement (the “**2020 LBS-008 R&D Agreement**”) with Lin BioScience, Inc. (our ultimate controlling shareholder), pursuant to which (i) our ultimate controlling shareholder agreed to provide certain new drug development services for pipeline LBS-008 to us from July 1, 2020 to June 30, 2021; (ii) our ultimate controlling shareholder acknowledged and agreed that we are the sole and exclusive owner of all intellectual property rights that our ultimate controlling shareholder directly or indirectly managed, developed or assisted in the performance of the services; and (iii) we agreed to pay service fees equal to 110% percent of actual costs for our ultimate controlling shareholder’s performance of such development services and to reimburse the actual expenses for transportation, travel and lodging for the performance of such development services. For such development services, the total consideration paid by us was \$57,828.12 to Lin BioScience, Inc.

**2021 LBS-008 R&D Services Agreement.** On July 1, 2021, we entered into a research and development services agreement (the “**2021 LBS-008 R&D Agreement**”) with Lin BioScience, Inc. (our ultimate controlling shareholder), pursuant to which (i) our ultimate controlling shareholder agreed to provide certain new drug development services for pipeline LBS-008 to us from July 1, 2021 to June 30, 2022; (ii) our ultimate controlling shareholder acknowledged and agreed that we are the sole and exclusive owner of all intellectual property rights that our ultimate controlling shareholder directly or indirectly managed, developed or assisted in the performance of the services; and (iii) we agreed to pay service fees equal to 110% percent of actual costs for our ultimate controlling shareholder’s performance of such development services and to reimburse the actual expenses for transportation, travel and lodging for the performance of such development services. On February 23, 2022, we entered into a first amendment to 2021 LBS-008 R&D Agreement with Lin BioScience, Inc., pursuant to which we granted our ultimate controlling shareholder a revocable, non-exclusive, non-transferable, royalty-free license (with the right to grant and authorize sublicenses) under RBP4 related patents in Taiwan to the extent necessary for our ultimate controlling shareholder to perform services stipulated under the 2021 LBS-008 R&D Agreement. For such development services, the total consideration paid by us was \$124,785.59 to Lin BioScience, Inc. as of the date of this prospectus.

### 2019 Loan Agreements

*2019 Loan Agreements between us and Lin Bioscience International Ltd.* On July 12, 2019 and September 30, 2019, we entered into two intercompany loan agreements (the “**Cayman 2019 July Loan Agreement**” the “**Cayman 2019 September Loan Agreement**”, respectively) with Lin Bioscience International Ltd. (our principal shareholder). Pursuant to the Cayman 2019 July Loan Agreement, Lin Bioscience International Ltd. agreed to provide an interest-free loan to us on request from time to time for a period of one year or any longer period as agreed by the parties commencing from July 12, 2019 with a facility limit of \$80,000 to assist with the conduct and/or facilitation by us of research and development in connection with clinical trials of LBS-008 or any other purpose approved by the lender in writing from time to time. Pursuant to the Cayman 2019 September Loan Agreement, Lin Bioscience International Ltd. agreed to provide an interest-free loan to us on request from time to time for a period of one year or any longer period as agreed by the parties commencing from September 30, 2019 with a facility limit of \$800,000 to assist with the conduct and/or facilitation by us of research and development in connection with clinical trials of LBS-008 or any other purpose approved by the lender in writing from time to time. On January 20, 2020, we entered into a first confirmation deed with Lin Bioscience International Ltd., which reduced the facility amount under the Cayman 2019 September Loan Agreement to \$300,000, by converting \$500,000 of the loan into equity via the issuance of 500,000 of our Ordinary Shares to Lin Bioscience International Ltd. On April 28, 2020, we entered into a second confirmation deed with Lin Bioscience International Ltd., which (i) reduced the facility limit under the Cayman 2019 September Loan Agreement to \$165,000 by repaying \$135,000 of the loan to Lin Bioscience International Ltd. no later than April 30, 2020; and (ii) terminated the Cayman 2019 July Loan Agreement subject to full repayment of the outstanding principal owed by us to Lin Bioscience International Ltd. no later than April 30, 2020. On August 14, 2020, we entered into a third confirmation deed with Lin Bioscience International Ltd., which terminated the Cayman 2019 September Loan Agreement, the first confirmation deed and the second confirmation deed subject to no facility amount under the Cayman 2019 September Loan Agreement, the first confirmation deed and the second confirmation deed draw down by us. As of the date of this prospectus, we have fully repaid the outstanding amount under the two loan agreements.

*2019 Loan Agreements between RBP4 Pty Ltd and Lin BioScience Pty Ltd.* On July 10, 2019 and on December 17, 2019, Lin BioScience Pty Ltd (the direct subsidiary of our ultimate controlling shareholder) entered into two intercompany loan agreements (the “**Australia 2019 July Loan Agreement**” and the “**Australia 2019 December Loan Agreement**”, respectively) with RBP4 Pty Ltd (our wholly owned subsidiary). Pursuant to the Australia 2019 July Loan Agreement, Lin BioScience Pty Ltd agreed to provide an interest-free loan to us on request from time to time for a period of one year or any longer period as agreed by the parties commencing from July 10, 2019 with a facility limit of AUD450,000 to assist with the conduct and/or facilitation by us of research and development in connection with clinical trials of LBS-008 or any other purpose approved by the lender in writing from time to time. Pursuant to the Australia 2019 December Loan Agreement, Lin BioScience Pty Ltd agreed to provide an interest-free loan to us on request from time to time for a period of one year or any longer period as agreed by the parties commencing from December 17, 2019 with a facility limit of AUD1,200,000 to assist with the conduct and/or facilitation by us of research and development in connection with clinical trials of LBS-008 or any other purpose approved by the lender in writing from time to time. On January 20, 2020, Lin BioScience Pty Ltd and RBP4 Pty Ltd entered into a confirmation deed, which (i) confirmed that the aggregate outstanding principal amount under the two loan agreements was AUD650,000; and (ii) terminated the two loan agreements subject to full repayment of the outstanding principal and all other amounts owed by RBP4 Pty Ltd to Lin BioScience Pty Ltd no later than January 31, 2020. As of the date of this prospectus, RBP4 Pty Ltd has fully repaid the outstanding amount under the two loan agreements.

*2019 Loan Agreements between us and Lin BioScience, Inc.* On August 12, 2019, Lin BioScience, Inc. (our ultimate controlling shareholder) entered into an intercompany debt funding agreement (the “**Cayman 2019 August Loan Agreement**”) with us. Pursuant to the Cayman 2019 August Loan Agreement, Lin BioScience, Inc. agreed to provide a loan to us on request from time to time for a period of one year or any longer period as agreed by the parties commencing from August 12, 2019 with a facility limit of \$800,000 to assist with the conduct and/or facilitation by us of research and development in connection with clinical trials of LBS-008 or any other purpose approved by the lender in writing from time to time. The loan bears an interest rate at the rate of 2.285% per annum. On April 28, 2020, we entered into a confirmation deed with

Lin BioScience, Inc., which (i) confirmed that the aggregate outstanding principal amount under the Cayman 2019 August Loan Agreement was \$800,000; and (ii) reduced the facility limit to \$450,000 by repaying \$350,000 of the loan to Lin BioScience, Inc. no later than April 30, 2020. As of the date of this prospectus, we have fully repaid the outstanding amount under the Cayman 2019 August Loan Agreement.

*2019 Loan Agreements between RBP4 Pty Ltd and Lin BioScience, Inc.* On August 12, 2019, Lin BioScience, Inc. (our ultimate controlling shareholder) entered into an intercompany debt funding agreement (the “**Australia 2019 August Loan Agreement**”) with RBP4 Pty Ltd (our wholly owned subsidiary). Pursuant to the Australia 2019 August Loan Agreement, Lin BioScience, Inc. agreed to provide a loan to our Australian subsidiary on request from time to time for a period of one year or any longer period as agreed by the parties commencing from August 12, 2019 with a facility limit of AUD1,000,000 to assist with the conduct and/or facilitation by us of research and development in connection with clinical trials of LBS-008 or any other purpose approved by the lender in writing from time to time. The loan bears an interest rate at the rate of 2.285% per annum. On April 28, 2020, RBP4 Pty Ltd and Lin BioScience, Inc. entered into a confirmation deed, which (i) confirmed that the aggregate outstanding principal amount under the Australia 2019 August Loan Agreement was AUD1,000,000; (ii) reduced the facility limit to AUD700,000 by repaying AUD300,000 of the loan to Lin BioScience, Inc. no later than May 8, 2020, as well as the accrued interests. As of the date of this prospectus, we have fully repaid the outstanding amount under the Australia 2019 August Loan Agreement.

#### 2020 Loan Agreements

*2020 Loan Agreement between RBP4 Pty Ltd and Lin BioScience Pty Ltd.* On January 20, 2020, Lin BioScience Pty Ltd (the direct subsidiary of our ultimate controlling shareholder) entered into an intercompany loan agreement (the “**2020 Lin Bio Loan Agreement**”) with RBP4 Pty Ltd (our wholly owned subsidiary), pursuant to which Lin BioScience Pty Ltd agreed to provide an interest-free loan to our Australian subsidiary on request from time to time for a period of one year or any longer period as agreed by the parties commencing from January 20, 2020 with a facility limit of AUD190,000 to assist with the conduct and/or facilitation by our Australian subsidiary of research and development in connection with clinical trials of LBS-008 or any other purpose approved by the lender in writing from time to time. On April 28, 2020, Lin BioScience Pty Ltd and RBP4 Pty Ltd entered into a first confirmation deed which reduced the facility limit to AUD185,000. On August 14, 2020, Lin BioScience Pty Ltd and RBP4 Pty Ltd entered into a second confirmation deed, which (i) confirmed that the outstanding principal amount was AUD185,000; and (ii) terminated the 2020 Lin Bio Loan Agreement and the first confirmation deed upon full repayment of the outstanding principal amount by RBP4 Pty Ltd no later than August 21, 2020. As of the date of this prospectus, RBP4 Pty Ltd has fully repaid the outstanding amount under the 2020 Lin Bio Loan Agreement.

*2020 Loan Agreement between RBP4 Pty Ltd and Lin BioScience, Inc.* On January 20, 2020, Lin BioScience, Inc. (our ultimate controlling shareholder) entered into an intercompany loan agreement (the “**2020 Lin BioScience Loan Agreement**”) with RBP4 Pty Ltd (our wholly owned subsidiary), pursuant to which Lin BioScience, Inc. agreed to provide a loan to our Australian subsidiary on request from time to time for a period of one year or any longer period as agreed by the parties commencing from January 20, 2020 with a facility limit of AUD300,000 to assist with the conduct and/or facilitation by our Australian subsidiary of research and development in connection with clinical trials of LBS-008 or any other purpose approved by the lender in writing from time to time. The loan bears an interest rate at the lower of (i) the rate of 2.275% per annum; and (ii) the interest rate relating to “inbound loans” specified in PCG2017/2 issued by the Australian Taxation Office from time to time (being 2.33% per annum at the date of 2020 Lin BioScience Loan Agreement). On April 28, 2020, RBP4 Pty Ltd and Lin BioScience, Inc. entered into a confirmation deed, which terminated the 2020 Lin BioScience Loan Agreement subject to no facility amount draw down by RBP4 Pty Ltd. As of the date of this prospectus, RBP4 Pty Ltd has fully repaid the outstanding amount under the 2020 Lin BioScience Loan Agreement.

## DESCRIPTION OF SHARE CAPITAL

We are a Cayman Islands exempted company incorporated with limited liability and our affairs are governed by our memorandum and articles of association, the Companies Act (As Revised) of the Cayman Islands, which we refer to as the Companies Act below, and the common law of the Cayman Islands.

As of the date of this prospectus, our authorized share capital is US\$50,000 divided into 500,000,000 shares, comprising of (i) 492,179,086 ordinary shares, par value US\$0.0001 per share, and (ii) 2,377,642 shares of series A preferred shares of a par value of US\$0.0001 each and (iii) 5,443,272 shares of series B preferred shares of a par value of US\$0.0001 each. As of the date of this prospectus, 10,274,403 ordinary shares are issued and outstanding, 2,377,642 series A preferred shares are issued and outstanding and 5,443,272 series B preferred shares are issued and outstanding. All of our issued and outstanding ordinary and preferred shares are fully paid. All of our outstanding preferred shares will automatically convert into ordinary shares on a one-for-one basis upon the completion of this offering.

Immediately prior to the completion of this offering, our authorized share capital will be changed into US\$50,000 divided into 500,000,000 shares comprising of (i) 400,000,000 ordinary shares of a par value of US\$0.0001 each, and (ii) 100,000,000 undesignated shares of a par value of US\$0.0001 each of such class or classes (however designated) as the board of directors may determine in accordance with our post-offering memorandum and articles of association. Immediately prior to the completion of this offering, we will have ordinary shares issued and outstanding, assuming the underwriters do not exercise their option to purchase additional ADSs. All of our shares issued and outstanding prior to the completion of the offering are and will be fully paid, and all of our shares to be issued in the offering will be issued as fully paid.

### **Our Post-Offering Memorandum and Articles of Association**

Our shareholders have conditionally adopted a third amended and restated memorandum and articles of association, which will become effective and replace our current second amended and restated memorandum and articles of association in its entirety immediately prior to the completion of this offering. The following are summaries of material provisions of the post-offering memorandum and articles of association and of the Companies Act, insofar as they relate to the material terms of our ordinary shares.

*Objects of Our Company.* Under our post-offering memorandum and articles of association, the objects of our company are unrestricted, and we have the full power and authority to carry out any object not prohibited by the laws of the Cayman Islands.

*Ordinary Shares.* Holders of our ordinary shares will have the same rights except for voting and conversion rights. Our ordinary shares are issued in registered form and are issued when registered in our register of members. We may not issue shares to bearer. Our shareholders who are non-residents of the Cayman Islands may freely hold and vote their shares.

*Dividends.* Our directors may from time to time declare dividends (including interim dividends) and other distributions on our shares in issue and authorize payment of the same out of the funds of our company lawfully available therefor. In addition, our shareholders may declare dividends by ordinary resolution, but no dividend may exceed the amount recommended by our directors. Our post-offering memorandum and articles of association provide that dividends may be declared and paid out of the funds of our Company lawfully available therefor. Under the laws of the Cayman Islands, our company may pay a dividend out of either profit or share premium account; and provided that in no circumstances may a dividend be paid if that would result in our company being unable to pay its debts as they fall due in the ordinary course of business immediately following the date on which the distribution or dividend is paid.

*Voting Rights.* Holders of our ordinary shares have the right to receive notice of, attend, speak and vote at general meetings of our company. Holders of ordinary shares shall, at all times, vote together as one class on all matters submitted to a vote by the members at any such general meeting. On all matters subject to a vote at general meetings of our company, (1) on a show of hands, each shareholder shall be entitled to one vote, whereas (2) on a poll, each shareholder shall be entitled to one vote per ordinary share. Our ordinary shares vote together as a single class on all matters submitted to a vote of our shareholders, except as may otherwise be required by law. Voting at any meeting of shareholders shall be decided by way of a poll save that the chairman of the meeting may, in good faith, allow a resolution which relates purely to a

procedural or administrative matter to be voted on by a show of hands. Where a show of hands is allowed, before or on the declaration of the results of the show of hands, a poll may be demanded by the chairman of such meeting or any shareholder present in person or by proxy at the meeting.

An ordinary resolution to be passed at a meeting by the shareholders requires the affirmative vote of a simple majority of the votes of the ordinary shares which are cast by those of our shareholders who attend and vote at the meeting, while a special resolution requires the affirmative vote of no less than two-thirds of the votes of the ordinary shares which are cast by those of our shareholders who attend and vote at the meeting. Under the Companies Act, a special resolution will be required in order for our company to effect certain important matters as stipulated in the Companies Act, such as a change of name or making changes to our post-offering memorandum and articles of association. Our shareholders may, among other things, divide or combine their shares by ordinary resolution.

*General Meetings of Shareholders.* As a Cayman Islands exempted company, we are not obliged by the Companies Act to call shareholders' annual general meetings. Our post-offering memorandum and articles of association provide that we may (but are not obliged to, unless as required by applicable law or the Nasdaq Stock Market rules) in each year hold a general meeting as our annual general meeting in which case we will specify the meeting as such in the notices calling it, and the annual general meeting will be held at such time and place as may be determined by our directors.

Shareholders' general meetings may be convened by the chairman of our board of directors or a majority of our directors (acting by a resolution of our board). Advance notice of at least seven calendar days is required for the convening of our annual general shareholders' meeting (if any) and any other general meeting of our shareholders. A quorum required for any general meeting of shareholders consists of one or more of our shareholders holding shares which carry in aggregate (or representing by proxy) not less than one-third of all votes attaching to the issued and outstanding shares in our company entitled to vote at such general meeting.

The Companies Act provides shareholders with only limited rights to requisition a general meeting, and does not provide shareholders with any right to put any proposal before a general meeting. However, these rights may be provided in a company's articles of association. Our post-offering memorandum and articles of association provide that upon the requisition of any one or more of our shareholders holding shares which carry in aggregate not less than one-third of all votes attaching to all issued and outstanding shares of our company entitled to vote at general meetings, our board will be required to convene an extraordinary general meeting and put the resolutions so requisitioned to a vote at such meeting. However, our post-offering memorandum and articles of association do not provide our shareholders with any right to put any proposals before annual general meetings or extraordinary general meetings not called by such shareholders.

*Transfer of Ordinary Shares.* Subject to the restrictions set out below, any of our shareholders may transfer all or any of his or her ordinary shares by an instrument of transfer in the usual or common form or any other form approved by our board of directors.

Our board of directors may, in its absolute discretion, decline to register any transfer of any ordinary share which is not fully paid up or on which we have a lien. Our board of directors may also decline to register any transfer of any ordinary share unless:

- the instrument of transfer is lodged with us, accompanied by the certificate for the ordinary shares to which it relates and such other evidence as our board of directors may reasonably require to show the right of the transferor to make the transfer;
- the instrument of transfer is in respect of only one class of ordinary shares;
- the instrument of transfer is properly stamped, if required;
- in the case of a transfer to joint holders, the number of joint holders to whom the ordinary share is to be transferred does not exceed four; and
- a fee of such maximum sum as Nasdaq Stock Market may determine to be payable or such lesser sum as our directors may from time to time require is paid to us in respect thereof.



If our directors refuse to register a transfer they must, within three calendar months after the date on which the instrument of transfer was lodged, send to each of the transferor and the transferee notice of such refusal.

The registration of transfers may, after compliance with any notice required of the Nasdaq Stock Market, be suspended and the register closed at such times and for such periods as our board of directors may from time to time determine; provided, however, that the registration of transfers may not be suspended nor the register closed for more than 30 days in any year.

*Liquidation.* On the winding up of our company, if the assets available for distribution amongst our shareholders will be more than sufficient to repay the whole of the share capital at the commencement of the winding up, the surplus will be distributed amongst our shareholders in proportion to the par value of the shares held by them at the commencement of the winding up, subject to a deduction from those shares in respect of which there are monies due, of all monies payable to our company for unpaid calls or otherwise. If our assets available for distribution are insufficient to repay all of the paid-up capital, such assets will be distributed so that, as nearly as may be, the losses are borne by our shareholders in proportion to the par value of the shares held by them.

*Calls on Shares and Forfeiture of Shares.* Our board of directors may from time to time make calls upon shareholders for any amounts unpaid on their shares in a notice served to such shareholders at least 14 calendar days prior to the specified time and place of payment. The shares that have been called upon and remain unpaid are subject to forfeiture.

*Redemption, Repurchase and Surrender of Shares.* We may issue shares on terms that such shares are subject to redemption, at our option or at the option of the holders of these shares, on such terms and in such manner as may be determined, before the issue of such shares, by our board of directors or by our shareholders by ordinary resolution. Our company may also redeem or repurchase any of our shares on such terms and in such manner as have been approved by our board of directors or by an ordinary resolution of our shareholders. Under the Companies Act, the redemption or repurchase of any share may be paid out of our Company's profits or out of the proceeds of a new issue of shares made for the purpose of such redemption or repurchase, or out of capital (including share premium account and capital redemption reserve) if our company can, immediately following such payment, pay its debts as they fall due in the ordinary course of business. In addition, under the Companies Act no such share may be redeemed or repurchased (a) unless it is fully paid up, (b) if such redemption or repurchase would result in there being no shares outstanding or (c) if the company has commenced liquidation. In addition, our company may accept the surrender of any fully paid share for no consideration.

*Variation of Rights of Shares.* Whenever the capital of our company is divided into different classes or series, the rights attached to any such class or series may, subject to any rights or restrictions for the time being attached to any class or series, only be materially adversely varied or abrogated with the consent in writing of the holders of not less than a majority of the issued shares of that class or with the sanction of an ordinary resolution passed at a separate meeting of the holders of the shares of that class. The rights conferred upon the holders of the shares of any class issued will not, unless otherwise expressly provided by the terms of issue of the shares of that class, be deemed to be varied or abrogated by the creation, allotment, or issue of further shares ranking *pari passu* with or subsequent to such existing class of shares, or the redemption or purchase of any shares of any class by our company. The rights of the holders of shares shall not be deemed to be varied or abrogated by the creation or issue of shares with preferred or other rights including, without limitation, the creation of shares with enhanced or weighted voting rights.

*Issuance of Additional Shares.* Our post-offering memorandum and articles of association authorize our board of directors to issue additional ordinary shares from time to time as our board of directors may determine, to the extent of available authorized but unissued shares.

Our post-offering memorandum and articles of association also authorize our board of directors to establish from time to time one or more series of preferred shares and to determine, with respect to any series of preferred shares, the terms and rights of that series, including:

- the designation of the series;



- the number of shares of the series;
- the dividend rights, dividend rates, conversion rights, voting rights;
- the rights and terms of redemption and liquidation preferences; and
- any other powers, preferences and relative, participating, optional and other special rights.

Our board of directors may issue preferred shares without action by our shareholders to the extent authorized but unissued. Issuance of these shares may dilute the voting power of holders of ordinary shares.

*Inspection of Books and Records.* Holders of our ordinary shares will have no general right under Cayman Islands law to inspect or obtain copies of our list of shareholders or our corporate records (other than our memorandum and articles of association and our register of mortgages and charges). However, we intend to provide our shareholders with annual audited financial statements. See “Where You Can Find Additional Information.”

*Anti-Takeover Provisions.* Some provisions of our post-offering memorandum and articles of association may discourage, delay or prevent a change of control of our company or management that shareholders may consider favorable, including provisions that:

- authorize our board of directors to issue preferred shares in one or more series and to designate the price, rights, preferences, privileges and restrictions of such preferred shares without any further vote or action by our shareholders; and
- limit the ability of shareholders to requisition and convene general meetings of shareholders.

However, under Cayman Islands law, our directors may only exercise the rights and powers granted to them under our post-offering memorandum and articles of association for a proper purpose and for what they believe in good faith to be in the best interests of our company.

*Changes in Capital.* Our shareholders may from time to time by ordinary resolution:

- increase our share capital by such sum, to be divided into shares of such classes and amount, as the resolution shall prescribe;
- consolidate and divide all or any of our share capital into shares of a larger amount than our existing shares;
- sub-divide our existing shares, or any of them into shares of a smaller amount, provided that in the subdivision the proportion between the amount paid and the amount, if any, unpaid on each reduced share shall be the same as it was in case of the share from which the reduced share is derived; or
- cancel any shares which, at the date of the passing of the resolution, have not been taken or agreed to be taken by any person and diminish the amount of our share capital by the amount of the shares so canceled.

Our shareholders may by special resolution, subject to confirmation by the Grand Court of the Cayman Islands on an application by our company for an order confirming such reduction, reduce our share capital or any capital redemption reserve in any manner permitted by law.

*Exempted Company.* We are an exempted company with limited liability under the Companies Act. The Companies Act distinguishes between ordinary resident companies and exempted companies. Any company that is registered in the Cayman Islands but conducts business mainly outside of the Cayman Islands may apply to be registered as an exempted company. The requirements for an exempted company are essentially the same as for an ordinary company except that an exempted company:

- does not have to file an annual return of its shareholders with the Registrar of Companies;
- is not required to open its register of members for inspection;
- does not have to hold an annual general meeting;
- may issue negotiable or bearer shares or shares with no par value;

- may obtain an undertaking against the imposition of any future taxation (such undertakings are usually given for 20 years in the first instance);
- may register by way of continuation in another jurisdiction and be deregistered in the Cayman Islands;
- may register as a limited duration company; and
- may register as a segregated portfolio company.

“Limited liability” means that the liability of each shareholder is limited to the amount unpaid by the shareholder on the shares of the company (except in exceptional circumstances, such as involving fraud, the establishment of an agency relationship or an illegal or improper purpose or other circumstances in which a court may be prepared to pierce or lift the corporate veil).

#### **Differences in Corporate Law**

The Companies Act is derived, to a large extent, from the older Companies Acts of England but does not follow recent English statutory enactments and, accordingly, there are significant differences between the Companies Act and the current Companies Act of England. In addition, the Companies Act differs from laws applicable to U.S. corporations and their shareholders. Set forth below is a summary of certain significant differences between the provisions of the Companies Act applicable to us and the laws applicable to companies incorporated in the United States and their shareholders.

*Mergers and Similar Arrangements.* The Companies Act permits mergers and consolidations between Cayman Islands companies and between Cayman Islands companies and non-Cayman Islands companies. For these purposes, (i) “merger” means the merging of two or more constituent companies and the vesting of their undertaking, property and liabilities in one of such companies as the surviving company, and (ii) a “consolidation” means the combination of two or more constituent companies into a consolidated company and the vesting of the undertaking, property and liabilities of such companies to the consolidated company. In order to effect such a merger or consolidation, the directors of each constituent company must approve a written plan of merger or consolidation, which must then be authorized by (a) a special resolution of the shareholders of each constituent company, and (b) such other authorization, if any, as may be specified in such constituent company’s articles of association. The written plan of merger or consolidation must be filed with the Registrar of Companies of the Cayman Islands together with a declaration as to the solvency of the consolidated or surviving company, a list of the assets and liabilities of each constituent company and an undertaking that a copy of the certificate of merger or consolidation will be given to the members and creditors of each constituent company and that notification of the merger or consolidation will be published in the Cayman Islands Gazette. Court approval is not required for a merger or consolidation which is effected in compliance with these statutory procedures.

A merger between a Cayman parent company and its Cayman subsidiary or subsidiaries does not require authorization by a resolution of shareholders of that Cayman subsidiary if a copy of the plan of merger is given to every member of that Cayman subsidiary to be merged unless that member agrees otherwise. For this purpose a company is a “parent” of a subsidiary if it holds issued shares that together represent at least ninety percent (90%) of the votes at a general meeting of the subsidiary.

The consent of each holder of a fixed or floating security interest over a constituent company is required unless this requirement is waived by a court in the Cayman Islands.

Save in certain limited circumstances, a shareholder of a Cayman constituent company who dissents from the merger or consolidation is entitled to payment of the fair value of his shares (which, if not agreed between the parties, will be determined by the Cayman Islands court) upon dissenting to a merger or consolidation, provide the dissenting shareholder complies strictly with the procedures set out in the Companies Act. The exercise of dissenter rights will preclude the exercise by the dissenting shareholder of any other rights to which he or she might otherwise be entitled by virtue of holding shares, save for the right to seek relief on the grounds that the merger or consolidation is void or unlawful.

Separate from the statutory provisions relating to mergers and consolidations, the Companies Act also contains statutory provisions that facilitate the reconstruction and amalgamation of companies by way of

schemes of arrangement, provided that the arrangement is approved by a majority in number of each class of shareholders and creditors with whom the arrangement is to be made, and who must in addition represent three-fourths in value of each such class of shareholders or creditors, as the case may be, that are present and voting either in person or by proxy at a meeting, or meetings, convened for that purpose. The convening of the meetings and subsequently the arrangement must be sanctioned by the Grand Court of the Cayman Islands. While a dissenting shareholder has the right to express to the court the view that the transaction ought not to be approved, the court can be expected to approve the arrangement if it determines that:

- the statutory provisions as to the required majority vote have been met;
- the shareholders have been fairly represented at the meeting in question and the statutory majority are acting bona fide without coercion of the minority to promote interests adverse to those of the class;
- the arrangement is such that may be reasonably approved by an intelligent and honest man of that class acting in respect of his interest; and
- the arrangement is not one that would more properly be sanctioned under some other provision of the Companies Act.

The Companies Act also contains a statutory power of compulsory acquisition which may facilitate the “squeeze out” of dissentient minority shareholder upon a tender offer. When a tender offer is made and accepted by holders of 90.0% of the shares within four months, the offeror may, within a two-month period commencing on the expiration of such four month period, require the holders of the remaining shares to transfer such shares to the offeror on the terms of the offer. An objection can be made to the Grand Court of the Cayman Islands but this is unlikely to succeed in the case of an offer which has been so approved unless there is evidence of fraud, bad faith or collusion.

If an arrangement and reconstruction by way of scheme of arrangement is thus approved and sanctioned, or if a tender offer is made and accepted in accordance with the foregoing statutory procedures, a dissenting shareholder would have no rights comparable to appraisal rights, which would otherwise ordinarily be available to dissenting shareholders of Delaware corporations, providing rights to receive payment in cash for the judicially determined value of the shares.

*Shareholders’ Suits.* In principle, we will normally be the proper plaintiff to sue for a wrong done to us as a company, and as a general rule a derivative action may not be brought by a minority shareholder. However, based on English authorities, which would in all likelihood be of persuasive authority in the Cayman Islands, the Cayman Islands court can be expected to follow and apply the common law principles (namely the rule in *Foss v. Harbottle* and the exceptions thereto) so that a non-controlling shareholder may be permitted to commence a class action against or derivative actions in the name of the company to challenge actions where:

- a company acts or proposes to act illegally or ultra vires;
- the act complained of, although not ultra vires, could only be effected duly if authorized by more than a simple majority vote that has not been obtained; and
- those who control the company are perpetrating a “fraud on the minority.”

*Indemnification of Directors and Executive Officers and Limitation of Liability.* Cayman Islands law does not limit the extent to which a company’s memorandum and articles of association may provide for indemnification of directors and officers, except to the extent any such provision may be held by the Cayman Islands courts to be contrary to public policy, such as to provide indemnification against civil fraud or the consequences of committing a crime. Our post-offering memorandum and articles of association provide that we shall indemnify our directors and officers, against all actions, proceedings, costs, charges, expenses, losses, damages or liabilities incurred or sustained by such directors or officer, other than by reason of such person’s dishonesty, willful default or fraud, in or about the conduct of our company’s business or affairs (including as a result of any mistake of judgment) or in the execution or discharge of his duties, powers, authorities or discretions, including without prejudice to the generality of the foregoing, any costs, expenses,

losses or liabilities incurred by such director or officer in defending (whether successfully or otherwise) any civil proceedings concerning our company or its affairs in any court whether in the Cayman Islands or elsewhere.

This standard of conduct is generally the same as permitted under the Delaware General Corporation Law for a Delaware corporation. In addition, we have entered into indemnification agreements with our directors and executive officers that provide such persons with additional indemnification beyond that provided in our post-offering amended and restated memorandum and articles of association.

Insofar as indemnification for liabilities arising under the Securities Act may be permitted to our directors, officers or persons controlling us under the foregoing provisions, we have been informed that in the opinion of the SEC, such indemnification is against public policy as expressed in the Securities Act and is therefore unenforceable.

*Directors' Fiduciary Duties.* Under Delaware corporate law, a director of a Delaware corporation has a fiduciary duty to the corporation and its shareholders. This duty has two components: the duty of care and the duty of loyalty. The duty of care requires that a director act in good faith, with the care that an ordinarily prudent person would exercise under similar circumstances. Under this duty, a director must inform himself of, and disclose to shareholders, all material information reasonably available regarding a significant transaction. The duty of loyalty requires that a director acts in a manner he reasonably believes to be in the best interests of the corporation. He must not use his corporate position for personal gain or advantage. This duty prohibits self-dealing by a director and mandates that the best interest of the corporation and its shareholders take precedence over any interest possessed by a director, officer or controlling shareholder and not shared by the shareholders generally. In general, actions of a director are presumed to have been made on an informed basis, in good faith and in the honest belief that the action taken was in the best interests of the corporation. However, this presumption may be rebutted by evidence of a breach of one of the fiduciary duties. Should such evidence be presented concerning a transaction by a director, the director must prove the procedural fairness of the transaction, and that the transaction was of fair value to the corporation.

As a matter of Cayman Islands law, a director of a Cayman Islands exempted company is in the position of a fiduciary with respect to the company and therefore it is considered that he owes the following duties to the company — a duty to act bona fide in the best interests of the company, a duty not to make a profit based on his position as director (unless the company permits him to do so), a duty not to put himself in a position where the interests of the company conflict with his personal interest or his duty to a third party, and a duty to exercise powers for the purpose for which such powers were intended. A director of a Cayman Islands exempted company owes to the company a duty to act with skill and care. It was previously considered that a director need not exhibit in the performance of his duties a greater degree of skill than may reasonably be expected from a person of his knowledge and experience. However, English and Commonwealth courts have moved towards an objective standard with regard to the required skill and care and these authorities are likely to be followed in the Cayman Islands.

*Shareholder Action by Written Consent.* Under the Delaware General Corporation Law, a corporation may eliminate the right of shareholders to act by written consent by amendment to its certificate of incorporation. Cayman Islands law and our post-offering memorandum and articles of association provide that shareholders may approve corporate matters by way of a unanimous written resolution signed by or on behalf of each shareholder who would have been entitled to vote on such matter at a general meeting without a meeting being held, and any such resolution in writing shall be as valid and effective as if the same had been passed at a general meeting of our company duly convened and held.

*Shareholder Proposals.* Under the Delaware General Corporation Law, a shareholder has the right to put any proposal before the annual meeting of shareholders; provided that it complies with the notice provisions in the governing documents. A special meeting may be called by the board of directors or any other person authorized to do so in the governing documents, but shareholders may be precluded from calling special meetings.

The Companies Act provides shareholders with only limited rights to requisition a general meeting, and does not provide shareholders with any right to put any proposal before a general meeting. However,

these rights may be provided in a company's articles of association. Our post-offering memorandum and articles of association allow any one or more of our shareholders holding shares which carry in aggregate not less than one-third of the total number votes attaching to all issued and outstanding shares of our company as of the date of the deposit that are entitled to vote at general meetings to requisition an extraordinary general meeting of our shareholders, in which case our board is obliged to convene an extraordinary general meeting and to put the resolutions so requisitioned to a vote at such meeting. Other than this right to requisition a shareholders' meeting, our post-offering memorandum and articles of association do not provide our shareholders with any other right to put proposals before annual general meetings or extraordinary general meetings. As a Cayman Islands exempted company, we are not obliged by law to call shareholders' annual general meetings.

*Cumulative Voting.* Under the Delaware General Corporation Law, cumulative voting for elections of directors is not permitted unless the corporation's certificate of incorporation specifically provides for it. Cumulative voting potentially facilitates the representation of minority shareholders on a board of directors since it permits the minority shareholder to cast all the votes to which the shareholder is entitled on a single director, which increases the shareholder's voting power with respect to electing such director.

There are no prohibitions in relation to cumulative voting under the laws of the Cayman Islands, but our post-offering memorandum and articles of association do not provide for cumulative voting. As a result, our shareholders are not afforded any less protections or rights on this issue than shareholders of a Delaware corporation.

*Removal of Directors.* Under the Delaware General Corporation Law, a director of a corporation with a classified board may be removed only for cause with the approval of a majority of the issued and outstanding shares entitled to vote, unless the certificate of incorporation provides otherwise. Under our post-offering memorandum and articles of association, directors may be removed by an ordinary resolution of our shareholders. A director's office shall be vacated if the director (i) becomes bankrupt or makes any arrangement or composition with his creditors; (ii) dies or is found to be or becomes of unsound mind; (iii) resigns his office by notice in writing; (iv) is prohibited by any applicable law or the Nasdaq Stock Market rules; (v) without special leave of absence from our board, is absent from meetings of our board for three consecutive meetings and our board resolves that his office be vacated; or (vi) is removed from office pursuant to any other provision of our post-offering memorandum and articles of association.

*Transactions with Interested Shareholders.* The Delaware General Corporation Law contains a business combination statute applicable to Delaware corporations whereby, unless the corporation has specifically elected not to be governed by such statute by amendment to its certificate of incorporation, it is prohibited from engaging in certain business combinations with an "interested shareholder" for three years following the date that such person becomes an interested shareholder. An interested shareholder generally is a person or a group who or which owns or owned 15% or more of the target's outstanding voting shares within the past three years. This has the effect of limiting the ability of a potential acquirer to make a two-tiered bid for the target in which all shareholders would not be treated equally. The statute does not apply if, among other things, prior to the date on which such shareholder becomes an interested shareholder, the board of directors approves either the business combination or the transaction which resulted in the person becoming an interested shareholder. This encourages any potential acquirer of a Delaware corporation to negotiate the terms of any acquisition transaction with the target's board of directors.

Cayman Islands law has no comparable statute. As a result, we cannot avail ourselves of the types of protections afforded by the Delaware business combination statute. However, although Cayman Islands law does not regulate transactions between a company and its significant shareholders, it does provide that such transactions must be entered into bona fide in the best interests of the company and not with the effect of constituting a fraud on the minority shareholders.

*Dissolution; Winding up.* Under the Delaware General Corporation Law, unless the board of directors approves the proposal to dissolve, dissolution must be approved by shareholders holding 100% of the total voting power of the corporation. Only if the dissolution is initiated by the board of directors may it be approved by a simple majority of the corporation's outstanding shares. Delaware law allows a Delaware corporation to include in its certificate of incorporation a supermajority voting requirement in connection with dissolutions initiated by either an order of the courts of the Cayman Islands or by the board of directors.

Under Cayman Islands law, a company may be wound up by either an order of the courts of the Cayman Islands or by a special resolution of its members or, if the company is unable to pay its debts as they fall due, by an ordinary resolution of its members. The court has authority to order winding up in a number of specified circumstances including where it is, in the opinion of the court, just and equitable to do so. Under the Companies Act, our company may be dissolved, liquidated or wound up by a special resolution of our shareholders, or, if we are unable to pay our debts as they fall due, by an ordinary resolution of our shareholders.

*Variation of Rights of Shares.* Under the Delaware General Corporation Law, a corporation may vary the rights of a class of shares with the approval of a majority of the outstanding shares of such class, unless the certificate of incorporation provides otherwise. Under our post-offering memorandum and articles of association, if our share capital is divided into more than one class of shares, the rights attached to any such class may only be materially adversely varied or abrogated with the consent in writing of the holders of not less than a majority of the issued shares of that class or with the sanction of an ordinary resolution passed at a separate meeting of the holders of the shares of that class. The rights conferred upon the holders of the shares of any class issued with preferred or other rights shall not, subject to any rights or restrictions for the time being attached to the shares of that class, be deemed to be materially adversely varied or abrogated by the creation, allotment or issue of further shares ranking *pari passu* with or subsequent to them or the redemption or purchase of any shares of any class by our company. The rights of the holders of shares shall not be deemed to be materially adversely varied or abrogated by the creation or issue of shares with preferred or other rights including, without limitation, the creation of shares with enhanced or weighted voting rights.

*Amendment of Governing Documents.* Under the Delaware General Corporation Law, a corporation's governing documents may be amended with the approval of a majority of the outstanding shares entitled to vote, unless the certificate of incorporation provides otherwise. Under the Companies Act and our post-offering memorandum and articles of association, our memorandum and articles of association may only be amended by a special resolution of our shareholders.

*Rights of Non-resident or Foreign Shareholders.* There are no limitations imposed by our post-offering memorandum and articles of association on the rights of non-resident or foreign shareholders to hold or exercise voting rights on our shares. In addition, there are no provisions in our post-offering memorandum and articles of association that require our company to disclose shareholder ownership above any particular ownership threshold.

#### **History of Securities Issuances**

The following is a summary of changes in our share capital in the past three years.

##### ***Ordinary shares***

On March 27, 2018, we issued 1 ordinary share to Mapcal Limited, which was transferred to Lin Bioscience International Ltd. on March 27, 2018.

We issued to Lin Bioscience International Ltd. (i) 99 ordinary shares for consideration of \$99.9999 on April 13, 2018; (ii) 5,340,221 ordinary shares for consideration of \$900,000 plus assignment of the rights, title, interests and obligations of Lin Bioscience International Ltd. under the exclusive license agreement by and between Lin Bioscience International Ltd. and Columbia University and the transfer of 1,600 shares of Belite Bio Holdings Corp. (formerly known as Lin BioScience Holdings Corporation) on July 2, 2018; (iii) 2,500,000 ordinary shares for consideration of \$2,500,000 on August 8, 2018; and (iv) 1,000,000 ordinary shares for consideration of \$1,000,000 on January 20, 2020. Lin Bioscience International Ltd. is wholly owned by Lin BioScience, Inc., our ultimate controlling shareholder.

On December 31, 2020, we issued 727,676 ordinary shares to the optionees for the options exercised. Specifically, we issued: (i) 367,515 ordinary shares to Yu-Hsin Lin, our Founder, Chief Executive Officer and Chairman of the Board of Directors; (ii) 257,260 ordinary shares to Hao-Yuan Chuang, our Chief Financial Officer; (iii) 36,751 ordinary shares to Hung-Wei Chen; (iv) 22,050 ordinary shares to Wan-Shan

Chen; (v) 22,050 ordinary shares to Ming-Chiu Wu; and (vi) 22,050 ordinary shares to Yun-Ju Huang, in their exercise of options granted.

On December 31, 2021, we issued 706,406 ordinary shares to the optionees for the options exercised. Specifically, we issued: (i) 364,213 ordinary shares to Yu-Hsin Lin, our Founder, Chief Executive Officer and Chairman of the Board of Directors; (ii) 254,950 ordinary shares to Hao-Yuan Chuang, our Chief Financial Officer; (iii) 21,684 ordinary shares to Hung-Wei Chen; (iv) 23,463 ordinary shares to Wan-Shan Chen; (v) 20,243 ordinary shares to Ming-Chiu Wu; and (vi) 21,853 ordinary shares to Yun-Ju Huang, in their exercise of options granted.

#### ***Preferred shares***

On January 31, 2020, we closed a private placement transaction pursuant to which we sold an aggregate of 1,296,963 Series A Preferred Shares for an aggregate consideration of \$2,789,600 in cash and conversion of two convertible promissory notes in the principal amount of \$1,000,000 each.

On February 14, 2020, we issued a total of 1,080,679 Series A Preferred Shares in connection with the second closing of the private placement transaction described above for an aggregate consideration of \$4,002,400 in cash.

On December 24, 2020, we closed a private placement transaction pursuant to which we sold an aggregate of 5,443,272 Series B Preferred Shares for an aggregate consideration of \$23,000,000 in cash.

#### ***Convertible Promissory Note***

On October 22, 2019, we issued a convertible promissory note with the principal amount of US\$1,000,000 with simple interest of 2.5% per annum to each of H&D Asset Management Co., Ltd. and Yun-Ju Huang. Pursuant to the note purchase agreement, the entire convertible promissory notes may be converted, at the option of the note holder, in to the type of equity securities issued in the next equity financing. On January 31, 2020, in conjunction with the first closing of Series A financing, the principal amount and the accrued but unpaid interests (in the total amount of US\$13,835.62) under both convertible promissory notes were converted into Series A Preferred Shares.

#### ***Options***

We have granted options to purchase our ordinary shares to certain of our officers (whether or not a director) or our employees or any of our Affiliates, any member of the Board, or any director of one of our Affiliates, or any eligible individual consultant or advisor. See “Management — Share Incentive Plans”.

Securities/Purchaser	Date of Issuance	Number of Securities	Exercise Price
<b>Options</b>			
Certain directors, officers and employees	December 17, 2019	Option to purchase up to 1,335,794 ordinary shares	\$0.1191
Certain directors, officers and employees	December 23, 2020	Option to purchase up to 2,807,381 ordinary shares	\$0.4386
Certain key consultants	March 1, 2021	Option to purchase up to 41,736 ordinary shares	\$4.2254

#### ***Amended and Restated Shareholders Agreement***

In connection with our issuance of Series B Preferred Shares, we entered into an amended and restated shareholders agreement with certain of our shareholders in December 2020.

The amended and restated shareholders agreement provides for certain special rights, including right of first refusal, co-sale rights, preemptive rights, registration rights and contains provisions governing the board of directors and other corporate governance matters. Unless specifically noted, those special rights attached to our preferred shares, as well as the corporate governance provisions, will automatically terminate upon

the completion of this offering. Each series of our preferred shares will be automatically converted to ordinary shares on a one-for-one basis immediately prior to the completion of this offering. For additional details on the effect of the automatic conversion and the related conversion ratio, see “Dilution,” “Capitalization” and “Principal Shareholders.”

Pursuant to our amended and restated shareholders agreement, we have granted certain registration rights to certain of our shareholders. Set forth below is a description of the registration rights granted under the agreement.

*Demand Registration Rights.* At any time after six months following the effectiveness of a registration statement for the initial public offering of our securities, the holders of at least 25% of the voting power of the registrable securities then issued and outstanding may request in writing that we file a registration statement covering the registration of at least 10% of the registrable securities then outstanding on any internationally recognized exchange that is reasonably acceptable to such requesting holders; provided that the aggregate proceeds from the offering that is the subject of the registration exceeds US\$50,000,000. Upon such a request, we shall, promptly give written notice of such request to all holders, and use our commercially reasonable efforts to cause the registration of all registrable securities that the holders request to be registered and included in such registration by written notice given by such holders to us within 15 days after our delivery of written notice to be registered and/or qualified for sale and distribution in such jurisdiction as the initiating holders may request. We are not obligated to effect more than three demand registrations. This demand registration right is subject to a customary exclusion right of underwriters. We are obligated to consummate no more than three (3) registrations that have been declared and ordered effective pursuant to such request.

*Registration on Form F-3.* If Form F-3 is available for an offering by holders, the holders of at least 10% of the voting power of the registrable securities then issued and outstanding may request in writing that we effect a registration on Form F-3; provided that the aggregate proceeds from the offering that is the subject of the registration exceeds US\$50,000,000. We shall promptly give written notice of the proposed registration and as soon as practicable, use our commercially reasonable efforts to cause all or such portion of such holder’s or holders’ registrable securities as are specified in such request, together with all or such portion of the registrable securities of any other holder or holders joining in such request as are specified in a written request by such other holder or holders given within 15 days after our delivery of written notice to be registered and qualified for sale and distribution in such jurisdiction. We are obligated to consummate no more than two (2) registrations that have been declared and ordered effective within any twelve (12)-month period preceding the date of such request.

We have the right to defer filing of a registration statement on Form F-3 or a demand registration under certain circumstances. For example, we shall not be obligated to register or qualify registrable securities if in any jurisdiction in which we would be required to execute a general consent to service of process in effecting such registration or qualification, unless we are already subject to service of process in such jurisdiction. If in the good faith judgment of the Board, it would be materially detrimental to us or our members for a registration statement to be filed in the near future, then we shall have the right to defer such filing for a period during which such filing would be materially detrimental, provided, that we may not utilize this right for more than ninety (90) days on any one occasion or more than once during any twelve (12) month period; provided, further, that we may not register any other its securities during such period.

*Piggyback Registration Rights.* If we propose to register for a public offering of our securities (other than registration statements relating to any employee benefit plan or a corporate reorganization or certain other exempted situations), we shall promptly give written notice of such registration to all holders of registrable securities and afford each such holder an opportunity to include in such registration all or any part of the registerable securities then held by such holder. If a holder decides not to include all of its registrable securities in any registration statement thereafter filed by us, such holder shall nevertheless continue to have the right to include any registrable securities in any applicable subsequent registration statement or registration statements as may be filed by us, subject to certain limitations. This piggyback registration right is subject to a customary exclusion right of underwriters.

*Expenses of Registration.* Subject to certain exceptions, we will bear all registration expenses. Each holder, however, shall bear its proportionate share of all of the underwriting discounts and selling



commissions applicable to the sale of registrable securities or other amounts payable to underwriter(s) or brokers in connection with such offering by the holders.

*Termination of Obligations.* Our obligations to effect any demand, Form F-3 or piggyback registration shall terminate upon the earlier of (i) the date that is 5 years from the date of closing of a firm commitment underwritten public offering of our Ordinary Shares (or depositary receipts or depositary shares therefor) in the United States pursuant to an effective registration statement under the United States Securities Act of 1933, as amended, with an offering price (net of underwriting commissions and expenses) that implies a market capitalization of our Company immediately prior to such offering of not less than US\$120,000,000 and that results in gross proceeds to our Company of at least US\$30,000,000, or in a public offering of our Ordinary Shares (or depositary receipts or depositary shares therefor) in another jurisdiction which results in the Ordinary Shares trading publicly on a recognized international securities exchange approved by the holders of at least a majority of the voting power of the issued and outstanding Series A Preferred Shares and Series B Preferred Shares (voting together as a single class and on an as converted basis), so long as such offering satisfies the foregoing market capitalization and gross proceeds requirements, and (ii) with respect to any holder, the date on which such holder may sell all of such holder's registrable securities under Rule 144 of the Securities Act in any ninety (90)-day period.

## DESCRIPTION OF AMERICAN DEPOSITARY SHARES

### American Depositary Shares

Deutsche Bank Trust Company Americas, as depositary, will register and deliver the ADSs. Each ADS will represent ownership of 1 share, deposited with Deutsche Bank AG, Hong Kong Branch, as custodian for the depositary. Each ADS will also represent ownership of any other securities, cash or other property which may be held by the depositary. The depositary's corporate trust office at which the ADSs will be administered is located at 1 Columbus Circle, New York, NY 10019, USA. The principal executive office of the depositary is located at 1 Columbus Circle, New York, NY 10019, USA.

The Direct Registration System, or DRS, is a system administered by The Depository Trust Company, or DTC, pursuant to which the depositary may register the ownership of uncertificated ADSs, which ownership shall be evidenced by periodic statements issued by the depositary to the ADS holders entitled thereto.

We will not treat ADS holders as our shareholders and accordingly, you, as an ADS holder, will not have shareholder rights. Cayman Islands law governs shareholder rights. The depositary will be the holder of the ordinary shares underlying your ADSs. As a holder of ADSs, you will have ADS holder rights. A deposit agreement among us, the depositary and you, as an ADS holder, and the beneficial owners of ADSs sets out ADS holder rights as well as the rights and obligations of the depositary. The laws of the State of New York govern the deposit agreement and the ADSs. See "*— Jurisdiction and Arbitration.*"

The following is a summary of the material provisions of the deposit agreement. For more complete information, you should read the entire deposit agreement and the form of American Depositary Receipt. For directions on how to obtain copies of those documents, see "*Where You Can Find Additional Information.*"

### Holding the ADSs

#### *How will you hold your ADSs?*

You may hold ADSs either (1) directly (a) by having an American Depositary Receipt, or ADR, which is a certificate evidencing a specific number of ADSs, registered in your name, or (b) by holding ADSs in DRS, or (2) indirectly through your broker or other financial institution. If you hold ADSs directly, you are an ADS holder. This description assumes you hold your ADSs directly. ADSs will be issued through DRS, unless you specifically request certificated ADRs. If you hold the ADSs indirectly, you must rely on the procedures of your broker or other financial institution to assert the rights of ADS holders described in this section. You should consult with your broker or financial institution to find out what those procedures are.

### Dividends and Other Distributions

#### *How will you receive dividends and other distributions on the shares?*

The depositary has agreed to pay to you the cash dividends or other distributions it or the custodian receives on ordinary shares or other deposited securities, after deducting its fees and expenses. You will receive these distributions in proportion to the number of ordinary shares your ADSs represent as of the record date (which will be as close as practicable to the record date for our ordinary shares) set by the depositary with respect to the ADSs.

- **Cash.** The depositary will convert or cause to be converted any cash dividend or other cash distribution we pay on the ordinary shares or any net proceeds from the sale of any ordinary shares, rights, securities or other entitlements under the terms of the deposit agreement into U.S. dollars if it can do so on a practicable basis, and can transfer the U.S. dollars to the United States and will distribute promptly the amount thus received. If the depositary shall determine in its judgment that such conversions or transfers are not practical or lawful or if any government approval or license is needed and cannot be obtained at a reasonable cost within a reasonable period or otherwise sought, the deposit agreement allows the depositary to distribute the foreign currency only to those ADS holders

to whom it is possible to do so. It will hold or cause the custodian to hold the foreign currency it cannot convert for the account of the ADS holders who have not been paid and such funds will be held for the respective accounts of the ADS holders. It will not invest the foreign currency and it will not be liable for any interest for the respective accounts of the ADS holders.

- Before making a distribution, any taxes or other governmental charges, together with fees and expenses of the depositary, that must be paid, will be deducted. See “*Taxation.*” It will distribute only whole U.S. dollars and cents and will round down fractional cents to the nearest whole cent. *If the exchange rates fluctuate during a time when the depositary cannot convert the foreign currency, you may lose some or all of the value of the distribution.*
- **Shares.** For any ordinary shares we distribute as a dividend or free distribution, either (1) the depositary will distribute additional ADSs representing such ordinary shares or (2) existing ADSs as of the applicable record date will represent rights and interests in the additional ordinary shares distributed, to the extent reasonably practicable and permissible under law, in either case, net of applicable fees, charges and expenses incurred by the depositary and taxes and/or other governmental charges. The depositary will only distribute whole ADSs. It will try to sell ordinary shares which would require it to deliver a fractional ADS and distribute the net proceeds in the same way as it does with cash. The depositary may sell a portion of the distributed ordinary shares sufficient to pay its fees and expenses, and any taxes and governmental charges, in connection with that distribution.
- **Elective Distributions in Cash or Shares.** If we offer holders of our ordinary shares the option to receive dividends in either cash or shares, the depositary, after consultation with us and having received timely notice as described in the deposit agreement of such elective distribution by us, has discretion to determine to what extent such elective distribution will be made available to you as a holder of the ADSs. We must timely first instruct the depositary to make such elective distribution available to you and furnish it with satisfactory evidence that it is legal to do so. The depositary could decide it is not legal or reasonably practicable to make such elective distribution available to you. In such case, the depositary shall, on the basis of the same determination as is made in respect of the ordinary shares for which no election is made, distribute either cash in the same way as it does in a cash distribution, or additional ADSs representing ordinary shares in the same way as it does in a share distribution. The depositary is not obligated to make available to you a method to receive the elective dividend in shares rather than in ADSs. There can be no assurance that you will be given the opportunity to receive elective distributions on the same terms and conditions as the holders of ordinary shares.
- **Rights to Purchase Additional Shares.** If we offer holders of our ordinary shares any rights to subscribe for additional shares, the depositary shall having received timely notice as described in the deposit agreement of such distribution by us, consult with us, and we must determine whether it is lawful and reasonably practicable to make these rights available to you. We must first instruct the depositary to make such rights available to you and furnish the depositary with satisfactory evidence that it is legal to do so. If the depositary decides it is not legal or reasonably practicable to make the rights available but that it is lawful and reasonably practicable to sell the rights, the depositary will endeavor to sell the rights and in a riskless principal capacity or otherwise, at such place and upon such terms (including public or private sale) as it may deem proper distribute the net proceeds in the same way as it does with cash. The depositary will allow rights that are not distributed or sold to lapse. In that case, you will receive no value for them.

If the depositary makes rights available to you, it will establish procedures to distribute such rights and enable you to exercise the rights upon your payment of applicable fees, charges and expenses incurred by the depositary and taxes and/or other governmental charges. The Depositary shall not be obliged to make available to you a method to exercise such rights to subscribe for ordinary shares (rather than ADSs).

U.S. securities laws may restrict transfers and cancellation of the ADSs represented by shares purchased upon exercise of rights. For example, you may not be able to trade these ADSs freely in the United States. In this case, the depositary may deliver restricted depositary shares that have the same terms as the ADSs described in this section except for changes needed to put the necessary restrictions in place.

There can be no assurance that you will be given the opportunity to exercise rights on the same terms and conditions as the holders of ordinary shares or be able to exercise such rights.

- **Other Distributions.** Subject to receipt of timely notice, as described in the deposit agreement, from us with the request to make any such distribution available to you, and provided the depositary has determined such distribution is lawful and reasonably practicable and feasible and in accordance with the terms of the deposit agreement, the depositary will distribute to you anything else we distribute on deposited securities by any means it may deem practicable, upon your payment of applicable fees, charges and expenses incurred by the depositary and taxes and/or other governmental charges. If any of the conditions above are not met, the depositary will endeavor to sell, or cause to be sold, what we distributed and distribute the net proceeds in the same way as it does with cash; or, if it is unable to sell such property, the depositary may dispose of such property in any way it deems reasonably practicable under the circumstances for nominal or no consideration, such that you may have no rights to or arising from such property.

The depositary is not responsible if it decides that it is unlawful or impractical to make a distribution available to any ADS holders. We have no obligation to register ADSs, shares, rights or other securities under the Securities Act. We also have no obligation to take any other action to permit the distribution of ADSs, shares, rights or anything else to ADS holders. This means that you may not receive the distributions we make on our shares or any value for them if we and/or the depositary determines that it is illegal or not practicable for us or the depositary to make them available to you.

## **Deposit, Withdrawal and Cancellation**

### ***How are ADSs issued?***

The depositary will deliver ADSs if you or your broker deposit ordinary shares or evidence of rights to receive ordinary shares with the custodian. Upon payment of its fees and expenses and of any taxes or charges, such as stamp taxes or stock transfer taxes or fees, the depositary will register the appropriate number of ADSs in the names you request and will deliver the ADSs to or upon the order of the person or persons entitled thereto.

Except for ordinary shares deposited by us in connection with this offering, no shares will be accepted for deposit during a period of 180 days after the date of this prospectus. The 180 day lock up period is subject to adjustment under certain circumstances as described in the section entitled “*Shares Eligible for Future Sales — Lock-up Agreements.*”

### ***How do ADS holders cancel an American Depositary Share?***

You may turn in your ADSs at the depositary’s corporate trust office or by providing appropriate instructions to your broker. Upon payment of its fees and expenses and of any taxes or charges, such as stamp taxes or stock transfer taxes or fees, the depositary will deliver the ordinary shares and any other deposited securities underlying the ADSs to you or a person you designate at the office of the custodian. Or, at your request, risk and expense, the depositary will deliver the deposited securities at its corporate trust office, to the extent permitted by law.

### ***How do ADS holders interchange between Certificated ADSs and Uncertificated ADSs?***

You may surrender your ADR to the depositary for the purpose of exchanging your ADR for uncertificated ADSs. The depositary will cancel that ADR and will send you a statement confirming that you are the owner of uncertificated ADSs. Alternatively, upon receipt by the depositary of a proper instruction from a holder of uncertificated ADSs requesting the exchange of uncertificated ADSs for certificated ADSs, the depositary will execute and deliver to you an ADR evidencing those ADSs.

## **Voting Rights**

### ***How do you vote?***

You may instruct the depositary to vote the ordinary shares or other deposited securities underlying your ADSs at any meeting at which you are entitled to vote pursuant to any applicable law, the provisions of

our memorandum and articles of association, and the provisions of or governing the deposited securities. *Otherwise, you could exercise your right to vote directly if you withdraw the ordinary shares. However, you may not know about the meeting sufficiently enough in advance to withdraw the ordinary shares.*

If we ask for your instructions and upon timely notice from us by regular, ordinary mail delivery, or by electronic transmission, as described in the deposit agreement, the depositary will notify you of the upcoming meeting at which you are entitled to vote pursuant to any applicable law, the provisions of our memorandum and articles of association, and the provisions of or governing the deposited securities, and arrange to deliver our voting materials to you. The materials will include or reproduce (a) such notice of meeting or solicitation of consents or proxies; (b) a statement that the ADS holders at the close of business on the ADS record date will be entitled, subject to any applicable law, the provisions of our memorandum and articles of association, and the provisions of or governing the deposited securities, to instruct the depositary as to the exercise of the voting rights, if any, pertaining to the ordinary shares or other deposited securities represented by such holder's ADSs; and (c) a brief statement as to the manner in which such instructions may be given to the depositary or deemed given in accordance with the second to last sentence of this paragraph if no instruction is received by the depositary to give a discretionary proxy to a person designated by us. Voting instructions may be given only in respect of a number of ADSs representing an integral number of ordinary shares or other deposited securities. For instructions to be valid, the depositary must receive them in writing on or before the date specified. The depositary will try, as far as practical, subject to applicable law and the provisions of our memorandum and articles of association, to vote or to have its agents vote the ordinary shares or other deposited securities (in person or by proxy) as you instruct. The depositary will only vote or attempt to vote as you instruct. If we timely requested the depositary to solicit your instructions but no instructions are received by the depositary from an owner with respect to any of the deposited securities represented by the ADSs of that owner on or before the date established by the depositary for such purpose, the depositary shall deem that owner to have instructed the depositary to give a discretionary proxy to a person designated by us with respect to such deposited securities, and the depositary shall give a discretionary proxy to a person designated by us to vote such deposited securities. However, no such instruction shall be deemed given and no such discretionary proxy shall be given with respect to any matter if we inform the depositary we do not wish such proxy given, substantial opposition exists or the matter materially and adversely affects the rights of holders of the ordinary shares.

We cannot assure you that you will receive the voting materials in time to ensure that you can instruct the depositary to vote the ordinary shares underlying your ADSs. In addition, there can be no assurance that ADS holders and beneficial owners generally, or any holder or beneficial owner in particular, will be given the opportunity to vote or cause the custodian to vote on the same terms and conditions as the holders of our ordinary shares.

The depositary and its agents are not responsible for failing to carry out voting instructions or for the manner of carrying out voting instructions. *This means that you may not be able to exercise your right to vote and you may have no recourse if the ordinary shares underlying your ADSs are not voted as you requested.*

In order to give you a reasonable opportunity to instruct the depositary as to the exercise of voting rights relating to deposited securities, if we request the depositary to act, we will give the depositary notice of any such meeting and details concerning the matters to be voted at least 30 business days in advance of the meeting date.

#### **Compliance with Regulations**

##### ***Information Requests***

Each ADS holder and beneficial owner shall (a) provide such information as we or the depositary may request pursuant to law, including, without limitation, relevant Cayman Islands law, any applicable law of the United States of America, our memorandum and articles of association, any resolutions of our Board of Directors adopted pursuant to such memorandum and articles of association, the requirements of any markets or exchanges upon which the ordinary shares, ADSs or ADRs are listed or traded, or to any requirements of any electronic book-entry system by which the ADSs or ADRs may be transferred, regarding the capacity in which they own or owned ADRs, the identity of any other persons then or previously interested in such ADRs and the nature of such interest, and any other applicable matters, and (b) be bound

by and subject to applicable provisions of the laws of the Cayman Islands, our memorandum and articles of association, and the requirements of any markets or exchanges upon which the ADSs, ADRs or ordinary shares are listed or traded, or pursuant to any requirements of any electronic book-entry system by which the ADSs, ADRs or ordinary shares may be transferred, to the same extent as if such ADS holder or beneficial owner held ordinary shares directly, in each case irrespective of whether or not they are ADS holders or beneficial owners at the time such request is made.

#### ***Disclosure of Interests***

Each ADS holder and beneficial owner shall comply with our requests pursuant to Cayman Islands law, the rules and requirements of the Nasdaq Stock Market and any other stock exchange on which the ordinary shares are, or will be, registered, traded or listed or our memorandum and articles of association, which requests are made to provide information, inter alia, as to the capacity in which such ADS holder or beneficial owner owns ADS and regarding the identity of any other person interested in such ADS and the nature of such interest and various other matters, whether or not they are ADS holders or beneficial owners at the time of such requests.

#### **Fees and Expenses**

As an ADS holder, you will be required to pay the following service fees to the depositary bank and certain taxes and governmental charges (in addition to any applicable fees, expenses, taxes and other governmental charges payable on the deposited securities represented by any of your ADSs):

<u>Service</u>	<u>Fees</u>
• To any person to which ADSs are issued or to any person to which a distribution is made in respect of ADS distributions pursuant to stock dividends or other free distributions of stock, bonus distributions, stock splits or other distributions (except where converted to cash)	Up to US\$0.05 per ADS issued
• Cancellation of ADSs, including the case of termination of the deposit agreement	Up to US\$0.05 per ADS cancelled
• Distribution of cash dividends	Up to US\$0.05 per ADS held
• Distribution of cash entitlements (other than cash dividends) and/or cash proceeds from the sale of rights, securities and other entitlements	Up to US\$0.05 per ADS held
• Distribution of ADSs pursuant to exercise of rights.	Up to US\$0.05 per ADS held
• Distribution of securities other than ADSs or rights to purchase additional ADSs	Up to US\$0.05 per ADS held
• Depositary services	Up to US\$0.05 per ADS held on the applicable record date(s) established by the depositary bank

As an ADS holder, you will also be responsible for paying certain fees and expenses incurred by the depositary bank and certain taxes and governmental charges (in addition to any applicable fees, expenses, taxes and other governmental charges payable on the deposited securities represented by any of your ADSs) such as:

- Fees for the transfer and registration of ordinary shares charged by the registrar and transfer agent for the ordinary shares in the Cayman Islands (i.e., upon deposit and withdrawal of ordinary shares).
- Expenses incurred for converting foreign currency into U.S. dollars.
- Expenses for cable, telex and fax transmissions and for delivery of securities.
- Taxes and duties upon the transfer of securities, including any applicable stamp duties, any stock transfer charges or withholding taxes (i.e., when ordinary shares are deposited or withdrawn from deposit).

- Fees and expenses incurred in connection with the delivery or servicing of ordinary shares on deposit.
- Fees and expenses incurred in connection with complying with exchange control regulations and other regulatory requirements applicable to ordinary shares, deposited securities, ADSs and ADRs.
- Any applicable fees and penalties thereon.

The depositary fees payable upon the issuance and cancellation of ADSs are typically paid to the depositary bank by the brokers (on behalf of their clients) receiving the newly issued ADSs from the depositary bank and by the brokers (on behalf of their clients) delivering the ADSs to the depositary bank for cancellation. The brokers in turn charge these fees to their clients. Depositary fees payable in connection with distributions of cash or securities to ADS holders and the depositary services fee are charged by the depositary bank to the holders of record of ADSs as of the applicable ADS record date.

The depositary fees payable for cash distributions are generally deducted from the cash being distributed or by selling a portion of distributable property to pay the fees. In the case of distributions other than cash (i.e., share dividends, rights), the depositary bank charges the applicable fee to the ADS record date holders concurrent with the distribution. In the case of ADSs registered in the name of the investor (whether certificated or uncertificated in direct registration), the depositary bank sends invoices to the applicable record date ADS holders. In the case of ADSs held in brokerage and custodian accounts (via DTC), the depositary bank generally collects its fees through the systems provided by DTC (whose nominee is the registered holder of the ADSs held in DTC) from the brokers and custodians holding ADSs in their DTC accounts. The brokers and custodians who hold their clients' ADSs in DTC accounts in turn charge their clients' accounts the amount of the fees paid to the depositary banks.

In the event of refusal to pay the depositary fees, the depositary bank may, under the terms of the deposit agreement, refuse the requested service until payment is received or may set off the amount of the depositary fees from any distribution to be made to the ADS holder.

The depositary may make payments to us or reimburse us for certain costs and expenses, by making available a portion of the ADS fees collected in respect of the ADR program or otherwise, upon such terms and conditions as we and the depositary bank agree from time to time.

#### **Payment of Taxes**

You will be responsible for any taxes or other governmental charges payable, or which become payable, on your ADSs or on the deposited securities represented by any of your ADSs. The depositary may refuse to register or transfer your ADSs or allow you to withdraw the deposited securities represented by your ADSs until such taxes or other charges are paid. It may apply payments owed to you or sell deposited securities represented by your ADSs to pay any taxes owed and you will remain liable for any deficiency. If the depositary sells deposited securities, it will, if appropriate, reduce the number of ADSs to reflect the sale and pay to you any net proceeds, or send to you any property, remaining after it has paid the taxes. You agree to indemnify us, the depositary, the custodian and each of our and their respective agents, directors, employees and affiliates for, and hold each of them harmless from, any claims with respect to taxes (including applicable interest and penalties thereon) arising from any refund of taxes, reduced rate of withholding at source or other tax benefit obtained for you. Your obligations under this paragraph shall survive any transfer of ADRs, any surrender of ADRs and withdrawal of deposited securities or the termination of the deposit agreement.

**Reclassifications, Recapitalizations and Mergers**

<u>If we:</u>	<u>Then:</u>
Change the nominal or par value of our ordinary shares	The cash, shares or other securities received by the depositary will become deposited securities.
Reclassify, split up or consolidate any of the deposited securities	Each ADS will automatically represent its equal share of the new deposited securities.
Distribute securities on the ordinary shares that are not distributed to you, or	The depositary may distribute some or all of the cash, shares or other securities it received. It may also deliver new ADSs or ask you to surrender your outstanding ADRs in exchange for new ADRs identifying the new deposited securities.
Recapitalize, reorganize, merge, liquidate, sell all or substantially all of our assets, or take any similar action	

**Amendment and Termination*****How may the deposit agreement be amended?***

We may agree with the depositary to amend the deposit agreement and the form of ADR without your consent for any reason. If an amendment adds or increases fees or charges, except for taxes and other governmental charges or expenses of the depositary for registration fees, facsimile costs, delivery charges or similar items, including expenses incurred in connection with foreign exchange control regulations and other charges specifically payable by ADS holders under the deposit agreement, or materially prejudices a substantial existing right of ADS holders, it will not become effective for outstanding ADSs until 30 days after the depositary notifies ADS holders of the amendment. *At the time an amendment becomes effective, you are considered, by continuing to hold your ADSs, to agree to the amendment and to be bound by the ADRs and the deposit agreement as amended.* If any new laws are adopted which would require the deposit agreement to be amended in order to comply therewith, we and the depositary may amend the deposit agreement in accordance with such laws and such amendment may become effective before notice thereof is given to ADS holders.

***How may the deposit agreement be terminated?***

The depositary will terminate the deposit agreement if we ask it to do so, in which case the depositary will give notice to you at least 90 days prior to termination. The depositary may also terminate the deposit agreement if the depositary has told us that it would like to resign, or if we have removed the depositary, and in either case we have not appointed a new depositary within 90 days. In either such case, the depositary must notify you at least 30 days before termination.

After termination, the depositary and its agents will do the following under the deposit agreement but nothing else: collect distributions on the deposited securities, sell rights and other property and deliver ordinary shares and other deposited securities upon cancellation of ADSs after payment of any fees, charges, taxes or other governmental charges. Six months or more after the date of termination, the depositary may sell any remaining deposited securities by public or private sale. After that, the depositary will hold the money it received on the sale, as well as any other cash it is holding under the deposit agreement, for the *pro rata* benefit of the ADS holders that have not surrendered their ADSs. It will not invest the money and has no liability for interest. After such sale, the depositary's only obligations will be to account for the money and other cash. After termination, we shall be discharged from all obligations under the deposit agreement except for our obligations to the depositary thereunder.

**Books of Depositary**

The depositary will maintain ADS holder records at its depositary office. You may inspect such records at such office during regular business hours but solely for the purpose of communicating with other holders in the interest of business matters relating to the Company, the ADRs and the deposit agreement.

The depositary will maintain facilities in the Borough of Manhattan, The City of New York to record and process the issuance, cancellation, combination, split-up and transfer of ADRs.



These facilities may be closed at any time or from time to time when such action is deemed necessary or advisable by the depository in connection with the performance of its duties under the deposit agreement or at our reasonable written request.

#### **Limitations on Obligations and Liability**

##### ***Limits on our Obligations and the Obligations of the Depository and the Custodian; Limits on Liability to Holders of ADSs***

The deposit agreement expressly limits our obligations and the obligations of the depository and the custodian. It also limits our liability and the liability of the depository. The depository and the custodian:

- are only obligated to take the actions specifically set forth in the deposit agreement without gross negligence or willful misconduct;
- are not liable if any of us or our respective controlling persons or agents are prevented or forbidden from, or subjected to any civil or criminal penalty or restraint on account of, or delayed in, doing or performing any act or thing required by the terms of the deposit agreement and any ADR, by reason of any provision of any present or future law or regulation of the United States or any state thereof, the Cayman Islands or any other country, or of any other governmental authority or regulatory authority or stock exchange, or on account of the possible criminal or civil penalties or restraint, or by reason of any provision, present or future, of our memorandum and articles of association or any provision of or governing any deposited securities, or by reason of any act of God or war or other circumstances beyond its control (including, without limitation, nationalization, expropriation, currency restrictions, work stoppage, strikes, civil unrest, revolutions, rebellions, explosions and computer failure);
- are not liable by reason of any exercise of, or failure to exercise, any discretion provided for in the deposit agreement or in our memorandum and articles of association or provisions of or governing deposited securities;
- are not liable for any action or inaction of the depository, the custodian or us or their or our respective controlling persons or agents in reliance upon the advice of or information from legal counsel, any person presenting ordinary shares for deposit or any other person believed by it in good faith to be competent to give such advice or information;
- are not liable for the inability of any holder of ADSs to benefit from any distribution on deposited securities that is not made available to holders of ADSs under the terms of the deposit agreement;
- are not liable for any special, consequential, indirect or punitive damages for any breach of the terms of the deposit agreement, or otherwise;
- may rely upon any documents we believe in good faith to be genuine and to have been signed or presented by the proper party;
- disclaim any liability for any action or inaction of any of us or our respective controlling persons or agents in reliance upon the advice of or information from legal counsel, accountants, any person presenting ordinary shares for deposit, holders and beneficial owners (or authorized representatives) of ADSs, or any person believed in good faith to be competent to give such advice or information; and
- disclaim any liability for inability of any holder to benefit from any distribution, offering, right or other benefit made available to holders of deposited securities but not made available to holders of ADS.

The depository and any of its agents also disclaim any liability (i) for any failure to carry out any instructions to vote, the manner in which any vote is cast or the effect of any vote or failure to determine that any distribution or action may be lawful or reasonably practicable or for allowing any rights to lapse in accordance with the provisions of the deposit agreement, (ii) the failure or timeliness of any notice from us, the content of any information submitted to it by us for distribution to you or for any inaccuracy of any translation thereof, (iii) any investment risk associated with the acquisition of an interest in the deposited

securities, the validity or worth of the deposited securities, the credit-worthiness of any third party, (iv) for any tax consequences that may result from ownership of ADSs, ordinary shares or deposited securities, or (v) for any acts or omissions made by a successor depository whether in connection with a previous act or omission of the depository or in connection with any matter arising wholly after the removal or resignation of the depository, provided that in connection with the issue out of which such potential liability arises the depository performed its obligations without gross negligence or willful misconduct while it acted as depository.

In the deposit agreement, we and the depository agree to indemnify each other under certain circumstances.

#### **Jurisdiction and Arbitration**

The laws of the State of New York govern the deposit agreement and the ADSs and we have agreed with the depository that the federal or state courts in the City of New York shall have exclusive jurisdiction to hear and determine any dispute arising from or in connection with the deposit agreement and that the depository will have the right to refer any claim or dispute arising from the relationship created by the deposit agreement to arbitration in accordance with the Commercial Arbitration Rules of the American Arbitration Association. The arbitration provisions of the deposit agreement do not preclude you from pursuing claims under the Securities Act or the Exchange Act in federal or state courts.

#### **Jury Trial Waiver**

The deposit agreement provides that each party to the deposit agreement (including each holder, beneficial owner and holder of interests in the ADRs) irrevocably waives, to the fullest extent permitted by applicable law, any right it may have to a trial by jury in any lawsuit or proceeding against us or the depository arising out of or relating to our shares, the ADSs or the deposit agreement, including any claim under the U.S. federal securities laws. If we or the depository opposed a jury trial demand based on the waiver, the court would determine whether the waiver was enforceable based on the facts and circumstances of that case in accordance with the applicable law.

#### **Requirements for Depository Actions**

Before the depository will issue, deliver or register a transfer of an ADS, split-up, subdivide or combine ADSs, make a distribution on an ADS, or permit withdrawal of ordinary shares, the depository may require:

- payment of stock transfer or other taxes or other governmental charges and transfer or registration fees charged by third parties for the transfer of any ordinary shares or other deposited securities and payment of the applicable fees, expenses and charges of the depository;
- satisfactory proof of the identity and genuineness of any signature or any other matters contemplated in the deposit agreement; and
- compliance with (A) any laws or governmental regulations relating to the execution and delivery of ADRs or ADSs or to the withdrawal or delivery of deposited securities and (B) such reasonable regulations and procedures as the depository may establish, from time to time, consistent with the deposit agreement and applicable laws, including presentation of transfer documents.

The depository may refuse to issue and deliver ADSs or register transfers of ADSs generally when the register of the depository or our transfer books are closed or at any time if the depository or we determine that it is necessary or advisable to do so.

#### **Your Right to Receive the Shares Underlying Your ADSs**

You have the right to cancel your ADSs and withdraw the underlying ordinary shares at any time except:

- when temporary delays arise because: (1) the depository has closed its transfer books or we have closed our transfer books; (2) the transfer of ordinary shares is blocked to permit voting at a shareholders' meeting; or (3) we are paying a dividend on our ordinary shares;

- when you owe money to pay fees, taxes and similar charges;
- when it is necessary to prohibit withdrawals in order to comply with any laws or governmental regulations that apply to ADSs or to the withdrawal of ordinary shares or other deposited securities, or other circumstances specifically contemplated by Section I.A.(1) of the General Instructions to Form F-6 (as such General Instructions may be amended from time to time); or
- for any other reason if the depository or we determine, in good faith, that it is necessary or advisable to prohibit withdrawals.

The depository shall not knowingly accept for deposit under the deposit agreement any ordinary shares or other deposited securities required to be registered under the provisions of the Securities Act, unless a registration statement is in effect as to such ordinary shares.

This right of withdrawal may not be limited by any other provision of the deposit agreement.

#### **Direct Registration System**

In the deposit agreement, all parties to the deposit agreement acknowledge that the DRS and Profile Modification System, or Profile, will apply to uncertificated ADSs upon acceptance thereof to DRS by DTC. DRS is the system administered by DTC pursuant to which the depository may register the ownership of uncertificated ADSs, which ownership shall be evidenced by periodic statements issued by the depository to the ADS holders entitled thereto. Profile is a required feature of DRS which allows a DTC participant, claiming to act on behalf of an ADS holder, to direct the depository to register a transfer of those ADSs to DTC or its nominee and to deliver those ADSs to the DTC account of that DTC participant without receipt by the depository of prior authorization from the ADS holder to register such transfer.

## SHARES ELIGIBLE FOR FUTURE SALE

Upon completion of this offering, we will have \_\_\_\_\_ ADSs outstanding, representing approximately \_\_\_\_\_ % of our outstanding ordinary shares. All of the ADSs sold in this offering will be freely transferable by persons other than by our “affiliates” without restriction or further registration under the Securities Act. Sales of substantial amounts of our ADSs in the public market could adversely affect prevailing market prices of our ADSs. Prior to this offering, there has been no public market for our ordinary shares or the ADSs. We have applied to list the ADSs on the Nasdaq Capital Market, but we cannot assure you that a regular trading market will develop in the ADSs. We do not expect that a trading market will develop for our ordinary shares not represented by the ADSs.

### Lock-up Agreements

We have agreed, for a period of 180 days after the date of this prospectus, not to offer, sell, contract to sell, pledge, grant any option to purchase, make any short sale, lend or otherwise dispose of, except in this offering, any of our ordinary shares or ADSs or securities that are substantially similar to our ordinary shares or ADSs, including but not limited to any options or warrants to purchase our ordinary shares, ADSs or any securities that are convertible into or exchangeable for, or that represent the right to receive, our ordinary shares, ADSs or any such substantially similar securities (other than pursuant to employee stock option plans existing on, or upon the conversion or exchange of convertible or exchangeable securities outstanding as of, the date such lock-up agreement was executed), or to file or cause to be filed any registration statement relating to the offering of any of our share capital, without the prior written consent of the representative of the underwriters.

Furthermore, each of our directors, executive officers and shareholders beneficially holding greater than 5% of our ordinary shares has also entered into a similar lock-up agreement for a period of 180 days from the date of this prospectus, subject to certain exceptions, with respect to our ordinary shares, ADSs and securities that are substantially similar to our ordinary shares or ADSs.

We are not aware of any plans by any significant shareholders to dispose of significant numbers of our ADSs or ordinary shares. However, one or more existing shareholders or owners of securities convertible or exchangeable into or exercisable for our ADSs or ordinary shares may dispose of significant numbers of our ADSs or ordinary shares in the future. We cannot predict what effect, if any, future sales of our ADSs or ordinary shares, or the availability of ADSs or ordinary shares for future sale, will have on the trading price of our ADSs from time to time. Sales of substantial amounts of our ADSs or ordinary shares in the public market, or the perception that these sales could occur, could adversely affect the trading price of our ADSs.

### Rule 144

All of our ordinary shares that will be outstanding upon the completion of this offering, other than those ordinary shares sold in this offering, are “restricted securities” as that term is defined in Rule 144 under the Securities Act and may be sold publicly in the United States only if they are subject to an effective registration statement under the Securities Act or pursuant to an exemption from the registration requirement such as those provided by Rule 144 and Rule 701 promulgated under the Securities Act. In general, beginning 90 days after the date of this prospectus, a person who at the time of a sale is not, and has not been during the three months preceding the sale, an affiliate of ours and has beneficially owned our restricted securities for at least six months will be entitled to sell the restricted securities without registration under the Securities Act, subject only to the availability of current public information about us, and will be entitled to sell restricted securities beneficially owned for at least one year without restriction. Persons who are our affiliates and have beneficially owned our restricted securities for at least six months may sell a number of restricted securities within any three-month period that (together with any sales aggregated with them) does not exceed the greater of the following:

- 1% of the then outstanding ordinary shares of the same class, in the form of ADSs or otherwise, which immediately after this offering will equal \_\_\_\_\_ ordinary shares; or
- the average weekly trading volume of our ordinary shares of the same class, in the form of ADSs or otherwise, during the four calendar weeks preceding the date on which notice of the sale is filed with the SEC.

Sales by our affiliates under Rule 144 are also subject to certain requirements relating to manner of sale, notice and the availability of current public information about us.

**Rule 701**

In general, under Rule 701 of the Securities Act, each of our employees, consultants or advisors who purchases ordinary shares from us in connection with a compensatory stock plan or other written agreement executed prior to the completion of this offering is eligible to resell those ordinary shares in reliance on Rule 144, but without compliance with some of the restrictions, including the holding period, contained in Rule 144.

**Registration Rights**

Upon completion of this offering, certain holders of our ordinary shares or their transferees will be entitled to request that we register their ordinary shares for resale under the Securities Act, following the expiration of the lock-up agreements described above.

## TAXATION

*The following summary of Cayman Islands and U.S. federal income tax considerations of an investment in the ADSs or ordinary shares is based upon laws and relevant interpretations thereof in effect as of the date of this registration statement, all of which are subject to change. This summary does not deal with all possible tax considerations relating to an investment in the ADSs or ordinary shares, such as the tax considerations under U.S. state and local tax laws or under the tax laws of jurisdictions other than the Cayman Islands and the United States. To the extent that the discussion relates to matters of Cayman Islands tax law, it represents the opinion of Maples and Calder (Hong Kong) LLP, our Cayman Islands legal counsel.*

### **Cayman Islands Taxation**

The Cayman Islands currently levies no taxes on individuals or corporations based upon profits, income, gains or appreciation and there is no taxation in the nature of inheritance tax or estate duty. There are no other taxes likely to be material to us levied by the government of the Cayman Islands except for stamp duties which may be applicable on instruments executed in, or brought within the jurisdiction of the Cayman Islands. The Cayman Islands is not party to any double tax treaties that are applicable to any payments made to or by our company. There are no exchange control regulations or currency restrictions in the Cayman Islands.

Payments of dividends and capital in respect of our ordinary shares and ADSs will not be subject to taxation in the Cayman Islands and no withholding will be required on the payment of dividends or capital to any holder of our ordinary shares or ADSs, nor will gains derived from the disposal of our ordinary shares or ADSs be subject to Cayman Islands income or corporation tax.

### **United States Federal Income Tax Considerations**

The following discussion is a general discussion of certain U.S. federal income tax considerations relating to the ownership and disposition of our ADSs or ordinary shares by U.S. Holders (as defined below) that acquire our ADSs in this offering and holds our ADSs as “capital assets” (generally, property held for investment) under the U.S. Internal Revenue Code of 1986, as amended (the “Code”). This discussion does not address any aspect of U.S. federal gift or estate tax, alternative minimum tax, the Medicare tax on net investment income, or the state, local or non-U.S. tax consequences of an investment in our ADSs or ordinary shares. This discussion is based on the Code, its legislative history, existing and proposed regulations promulgated thereunder, published rulings and court decisions, all as of the date of this prospectus. These laws are subject to change, possibly on a retroactive basis. No ruling has been obtained and no ruling will be requested from the U.S. Internal Revenue Service (the “IRS”), with respect to any of the U.S. federal income tax consequences described below, and as a result, there can be no assurance that the IRS will not disagree with or challenge any of the statements provided below.

This discussion is not a complete description of all tax considerations that may be relevant to particular investors in light of their individual circumstances or investors subject to special tax rules, such as:

- brokers or dealers in securities or currencies;
- traders in securities that elect to use a mark-to-market method of tax accounting for securities holdings;
- banks or certain financial institutions;
- insurance companies;
- tax-exempt organizations;
- partnerships or other entities treated as partnerships or other pass-through entities for U.S. federal income tax purposes or persons holding our ADSs or ordinary shares through any such entities;
- regulated investment companies or real estate investment trusts;
- persons that hold our ADSs or ordinary shares as part of a hedge, straddle, constructive sale, conversion transaction or other integrated investment;

- persons whose functional currency for tax purposes is not the U.S. dollar;
- U.S. expatriates; or
- persons that actually or constructively own 10% or more of (i) the total combined voting power of all classes of our voting stock or (ii) the total value of all classes of our stock (including our ADSs or ordinary shares).

Each prospective investor is urged to consult its tax advisor regarding the application of U.S. federal taxation to its particular circumstances, and the state, local, non-U.S. and other tax considerations of the ownership and disposition of our ADSs or ordinary shares.

#### **General**

For purposes of this discussion, a “U.S. Holder” is a beneficial owner of our ADSs or ordinary shares that is:

- an individual citizen or resident of the United States for U.S. federal income tax purposes;
- a corporation, or other entity classified as a corporation for U.S. federal income tax purposes, that was created or organized in or under the laws of the United States, any state thereof or the District of Columbia;
- an estate the income of which is subject to U.S. federal income tax regardless of its source; or
- a trust if (i) a court within the United States is able to exercise primary supervision over its administration and one or more U.S. persons have the authority to control all substantial decisions of the trust, or (ii) the trust has a valid election in effect to be treated as a U.S. person.

For U.S. federal income tax purposes, income earned through an entity or arrangement classified as a partnership for U.S. federal income tax purposes is attributed to its owners. Accordingly, if a partnership (or other entity treated as a partnership for U.S. federal income tax purposes) is a beneficial owner of our ADSs or ordinary shares, the tax treatment of a partner in the partnership will generally depend upon the status of the partner and the activities of the partnership. Partnerships holding our ADSs or ordinary shares and their partners are urged to consult their tax advisors regarding an investment in our ADSs or ordinary shares.

For U.S. federal income tax purposes, it is generally expected that a U.S. Holder of ADSs will be treated as the beneficial owner of the underlying shares represented by the ADSs. The remainder of this discussion assumes that a U.S. Holder of our ADSs will be treated in this manner. Accordingly, deposits or withdrawals of ordinary shares for ADSs will generally not be subject to U.S. federal income tax.

#### **Dividends**

The following discussion is subject to the discussion under “Passive Foreign Investment Company” below. If we make cash distributions and you are a U.S. Holder, the gross amount of any distributions with respect to your ADSs or ordinary shares (including the amount of any taxes withheld therefrom) will be includible in your gross income on the day you actually or constructively receive such income as dividend income if the distributions are made from our current or accumulated earnings and profits, calculated according to U.S. federal income tax principles. We do not intend to calculate our earnings and profits according to U.S. federal income tax principles. Accordingly, you should expect that distributions on our ADSs or ordinary shares, if any, will generally be treated as dividend income for U.S. federal income tax purposes. Dividends received on our ADSs or ordinary shares will not be eligible for the dividends received deduction generally allowed to U.S. corporations. Dividends received by individuals and certain other non-corporate U.S. Holders may be subject to tax at the lower capital gain tax rate applicable to “qualified dividend income,” provided that certain conditions are satisfied, including that (1) our ADSs or ordinary shares on which the dividends are paid are readily tradeable on an established securities market in the United States, (2) we are neither a PFIC nor treated as such with respect to such a U.S. Holder for the taxable year in which the dividend was paid and the preceding taxable year, and (3) certain holding period requirements are met. We expect our ADSs (but not our ordinary shares), which we have applied to list on

the Nasdaq Capital Market will be considered readily tradeable on an established securities market in the United States, although there can be no assurance in this regard. U.S. Holders should consult their own tax advisors regarding the potential availability of the reduced dividend tax rate in respect of our ADSs and ordinary shares.

Dividends paid on our ADSs or ordinary shares, if any, will generally be treated as income from foreign sources and will generally constitute passive category income for U.S. foreign tax credit purposes. Depending on the U.S. Holder's individual facts and circumstances, a U.S. Holder may be eligible, subject to a number of complex limitations, to claim a foreign tax credit in respect of any nonrefundable non-U.S. withholding taxes imposed on dividends received on our ADSs or ordinary shares. A U.S. Holder who does not elect to claim a foreign tax credit for foreign taxes withheld may instead claim a deduction, for U.S. federal income tax purposes, in respect of such withholding, but only for a year in which such holder elects to do so for all creditable foreign income taxes. The rules governing the foreign tax credit are complex and their outcome depends in large part on the U.S. Holder's individual facts and circumstances. Accordingly, U.S. Holders are urged to consult their tax advisors regarding the availability of the foreign tax credit under their particular circumstances.

#### ***Sale or Other Disposition***

The following discussion is subject to the discussion under "Passive Foreign Investment Company" below. A U.S. Holder will generally recognize capital gain or loss upon the sale or other disposition of our ADSs or ordinary shares in an amount equal to the difference between the amount realized upon the disposition and the holder's adjusted tax basis in such ADSs or ordinary shares. The holder's adjusted tax basis will generally equal the amount the holder paid (including the offering price for the ADS or ordinary shares and trading fee, transaction levy and brokerage fee paid in connection with such purchase). Any gain or loss the U.S. Holder recognizes will generally be long-term capital gain or loss if the ADSs or ordinary shares have been held for more than one year and will generally be U.S.-source gain or loss for U.S. foreign tax credit purposes. Long-term capital gain of individuals and certain other non-corporate U.S. Holders will generally be eligible for a more favorable rate of taxation. The deductibility of a capital loss may be subject to limitations.

U.S. Holders are urged to consult their tax advisors regarding the tax consequences if a foreign tax is imposed on a disposition of our ADSs or ordinary shares, including the availability of the foreign tax credit under their particular circumstances.

#### ***Passive Foreign Investment Company***

If we were classified as a PFIC for any taxable year during which a U.S. Holder holds our ADSs or ordinary shares, the U.S. Holder would generally be subject to adverse U.S. tax consequences, in the form of increased tax liabilities (unless certain elections described below are timely made) and special U.S. tax reporting requirements.

A non-U.S. corporation is a PFIC for U.S. federal income tax purposes for any taxable year in which (after taking into account the income and assets of subsidiaries in which it owns at least a 25% interest by value), (i) at least 75% of its gross income is "passive" income, such as interest and income from financial investments (the "income test") or (ii) at least 50% of the average value of its assets (generally determined on a quarterly basis) consists of assets that produce or are held to produce passive income (the "asset test"). For purposes of making a PFIC determination, the non-U.S. corporation will be treated as owning its proportionate share of the assets and earning its proportionate share of the gross income of any other corporation of which it is, directly or indirectly, a 25% or greater shareholder (by value). For purposes of the asset test, any cash and cash invested in short-term, interest bearing, debt instruments, or bank deposits that are readily convertible into cash will generally count as producing passive income or held for the production of passive income, and goodwill should be treated as an active asset to the extent that it is associated with activities that produce or are intended to produce active income.

Based on current estimate of our gross income and of the value of our gross assets (including goodwill) and the manner in which we conduct our business, we do not expect to be a PFIC for U.S. federal income tax purposes for the 2022 taxable year. Despite our expectation, there can be no assurance that we will not be



a PFIC for 2022 or any future taxable year as PFIC status is tested for each taxable year and will depend on the composition of our assets and income in such taxable year. We could be a PFIC for any taxable year if our market capitalization were to decrease significantly while we hold substantial cash and cash equivalents, or if the gross income that we and our subsidiaries earn from investing the portion of the cash raised in the offering is substantial in comparison with the gross income from our business operation. Furthermore, the application of the PFIC rules is subject to uncertainty in several respects, and there can be no assurance that the IRS will not challenge our application of the PFIC rules. *Our counsel expresses no opinion with respect to our expectations contained in this paragraph.*

If we were a PFIC for any taxable year during which you held our ADSs or ordinary shares, certain adverse U.S. federal income tax rules would apply. You would generally be subject to additional taxes and interest charges on certain “excess distributions” we make on any gain realized on the disposition or deemed disposition of your ADSs or ordinary shares, regardless of whether we continue to be a PFIC in the year in which you receive an “excess distribution” or dispose of or are deemed to have disposed of, your our ADSs or ordinary shares. Distributions in respect of our ADSs or ordinary shares during a taxable year in which we are a PFIC would generally constitute “excess distributions” if, in the aggregate, they exceed 125% of the average amount of distributions with respect to your ADSs or ordinary shares over the three preceding taxable years or, if shorter, the portion of your holding period before such taxable year.

To compute the tax on “excess distributions” or any gain, (i) the “excess distribution” or the gain would be allocated ratably to each day in your holding period, (ii) the amount allocated to the current year and any tax year prior to the first taxable year in which we were a PFIC would be taxed as ordinary income in the current year, (iii) the amount allocated to other taxable years would be taxable at the highest applicable marginal rate in effect for that year, and (iv) an interest charge at the rate for underpayment of taxes for any period described under (iii) above would be imposed on the resulting tax liability on the portion of the “excess distribution” or gain that is allocated to such period. In addition, if we were a PFIC (or treated as a PFIC with respect to you) for any taxable year in which we make a distribution or the preceding taxable year, such distribution would not qualify for taxation at the more favorable tax rate if we are deemed to be a PRC resident enterprise under PRC tax law, as discussed in the “Dividends” section above.

Under certain attribution rules, if we were a PFIC for any taxable year in which you hold our ADSs or ordinary shares, you would be deemed to own your proportionate share of lower-tier PFICs, and would be subject to U.S. federal income tax under the PFIC rules described in the preceding paragraphs on (i) a distribution on the shares of a lower-tier PFIC and (ii) a disposition of shares of a lower-tier PFIC, both as if such U.S. Holder directly held the shares of such lower-tier PFIC.

You might be able to make a “mark-to-market” election with respect to our ADSs, but not our ordinary shares, in order to elect out of the tax treatment discussed above. If you make a valid mark-to-market election, you will include in gross income for each taxable year that we are treated as a PFIC an amount equal to the excess, if any, of the fair market value of your ADSs as of the close of such taxable year over your adjusted basis in such ADSs. You will be permitted a deduction for the excess, if any, of the adjusted basis of your ADSs over their fair market value as of the close of the taxable year. However, deductions are allowable only to the extent of any net mark-to-market gains on the ADSs included in your income for prior taxable years. Amounts included in your income under a mark-to-market election, as well as gain on any sale or other disposition of the ADSs, will be treated as ordinary income. Ordinary loss treatment also will apply to the deductible portion of any mark-to-market loss on the ADSs, as well as to any loss realized on a sale or disposition of the ADSs, to the extent that the amount of such loss does not exceed the net mark-to-market gains previously included for such ADSs. Your basis in your ADSs will be adjusted to reflect any such income or loss amounts. If you make a valid mark-to-market election, the tax rules that apply to distributions by corporations that are not PFICs generally will apply to distributions by us, except that the favorable rate discussed in the “Dividends” section above that may apply if we are deemed to be a PRC resident enterprise under PRC tax law will not apply to any distribution if we are a PFIC (or treated as a PFIC with respect to you) in the taxable year of the distribution or the preceding taxable year. If a U.S. Holder makes a mark-to-market election in respect of our ADSs and we cease to be classified as a PFIC, the holder will not be required to take into account the gain or loss described above during any period that we are not classified as a PFIC.

The mark-to-market election is available only for “marketable stock,” which is stock that is traded in other than de minimis quantities on at least 15 days during each calendar quarter on a qualified exchange or other market, as defined in applicable U.S. Treasury regulations. For those purposes, we expect that our ADSs will each be treated as marketable stock upon their listing on the Nasdaq Stock Market, and we expect the exchange will be a qualified exchange for these purposes. We anticipate that our ADSs should qualify as being regularly traded. U.S. Holders of ordinary shares may be able to make a mark-to-market election but it is not certain, but no assurances may be given in this regard and such holders are advised to consult their own tax advisor regarding their eligibility to make such election. Because a mark-to-market election cannot technically be made for equity interests in lower-tier PFICs that we own, if we are a PFIC for any taxable year, a U.S. Holder generally will continue to be subject to the general PFIC rules with respect to the holder’s indirect interest in any investments held by us that are treated as equity interest in a PFIC for U.S. federal income tax purposes. You should consult your tax advisor as to the availability and desirability of a mark-to-market election if we were a PFIC, as well as the impact of such election on interests in any lower-tier PFICs. The PFIC rules provide for a separate election, referred to as a qualified electing fund election, which, if available, results in a tax treatment different from (and generally less adverse than) the general PFIC tax treatment described above. That election, however, will not be available to you as we do not intend to provide the information you would need to make or maintain that election.

If you own our ADSs or ordinary shares during any taxable year that we are a PFIC, you will generally be required to file an annual report containing such information as the United States Treasury Department may require. You should consult your own tax advisor regarding the application of the PFIC rules to your investment in our ADSs or ordinary shares and the elections discussed above.

#### ***U.S. Information Reporting and Backup Withholding Rules***

Dividend payments with respect to our ADSs or ordinary shares and the proceeds received on the sale or other disposition of our ADSs or ordinary shares may be subject to information reporting to the IRS and to backup withholding, unless you are an exempt recipient. Backup withholding will not apply, however, if you provide a taxpayer identification number, certifying that you are not subject to backup withholding or are otherwise exempt from backup withholding. Any amounts withheld under the backup withholding rules from a payment to you will be refunded or credited against your U.S. federal income tax liability, provided that the required information is timely provided to the IRS. Certain U.S. Holders who hold “specific foreign financial assets,” including stock of a non-U.S. corporation that is not held in an account maintained by a U.S. “financial institution” may be required to attach to their tax returns for the year certain specified information. A U.S. Holder who fails to timely furnish the required information may be subject to a penalty. You are advised to consult with your own tax advisor regarding the application of the U.S. information reporting and backup withholding rules to your particular circumstances.

**PROSPECTIVE INVESTORS IN OUR ADSS OR ORDINARY SHARES SHOULD CONSULT WITH THEIR OWN TAX ADVISOR REGARDING THE APPLICATION OF THE U.S. FEDERAL INCOME TAX LAWS TO THEIR PARTICULAR SITUATIONS AS WELL AS ANY TAX CONSEQUENCES RESULTING FROM OWNING OR DISPOSING OUR ADSS OR ORDINARY SHARES, INCLUDING THE APPLICABILITY AND EFFECT OF THE TAX LAWS OF ANY STATE, LOCAL OR NON-US JURISDICTION AND INCLUDING ESTATE, GIFT AND INHERITANCE LAWS.**

## UNDERWRITING

The Benchmark Company is acting as the representative of the underwriters and the book-running manager of the offering of the ADSs described in this prospectus. We will enter into an underwriting agreement with the representative of the underwriters. Subject to the terms and conditions of the underwriting agreement, we have agreed to sell to the underwriters, and each underwriter has severally agreed to purchase, at the public offering price less the underwriting discounts and commissions set forth on the cover page of this prospectus, the number of ADSs listed next to its name in the following table:

Name	Number of ADSs
The Benchmark Company, LLC	
Total	

The underwriters are committed to purchase all the ADSs offered by us other than those covered by the option to purchase additional ADSs described below, if they purchase any ADSs. The obligations of the underwriters may be terminated upon the occurrence of certain events specified in the underwriting agreement. Pursuant to the underwriting agreement, the underwriters' obligations are subject to customary conditions, representations and warranties contained in the underwriting agreement, such as receipt by the underwriters of officers' certificates and legal opinions.

The underwriters are offering the ADSs, subject to prior sale, when, as and if issued to and accepted by them, subject to approval of legal matters by their counsel and other conditions specified in the underwriting agreement. The underwriters reserve the right to withdraw, cancel or modify offers to the public and to reject orders in whole or in part.

The underwriters propose to offer the ADSs directly to the public at the initial public offering price set forth on the cover page of this prospectus and to certain dealers at such price less a concession not in excess of US\$            per ADS. After the initial offering of the ADSs to the public, if all of the ADSs are not sold at the initial public offering price, the underwriters may change the offering price and the other selling terms.

Some of the underwriters are expected to make offers and sales both inside and outside the United States through their respective selling agents. All sales of ADSs in the United States will be made by broker-dealers registered with the SEC. Sales of any ADSs made outside of the United States may be made by affiliates of the underwriters.

We have agreed to indemnify the underwriters against certain liabilities, including liabilities under the Securities Act of 1933, as amended, and to contribute to payments the underwriters may be required to make in respect thereof.

### Option to purchase additional ADSs

We have granted to the underwriters an option to purchase up to            additional ADSs from us at the public offering price per ADS, less underwriting discounts and commissions, for a period of 30 days from the date of this prospectus. If any additional ADSs are purchased, the underwriters will offer the additional ADSs on the same terms as those on which the ADSs are being offered.

### Underwriting Discounts and Commissions

The following table shows the per ADS and total public offering price, underwriting discounts and commissions to be paid by us, and proceeds before expenses to us, assuming both no exercise and full exercise of the underwriters' option to purchase            additional ADSs.

	Total		
	Per ADS	No Exercise	Full exercise
Public offering price	US\$	US\$	US\$
Underwriting discounts and commissions <sup>(1)</sup>	US\$	US\$	US\$
Proceeds, before expenses, to us	US\$	US\$	US\$

- 
- (1) Underwriting discounts and commissions per ADS will be 7.5%, provided that, with respect to the sale of ADSs to certain identified investors only, the underwriting discounts and commissions per ADS will be 3.75%.

We have agreed to pay for the accountable out-of-pocket expenses of the underwriters, including road show expenses for the offering, prospectus tracking and compliance software for the offering, fees and disbursements of the underwriters' counsel up to an amount of \$125,000, and the preparation of commemorative mementos and lucite tombstones in connection with the offering, up to \$150,000 in the aggregate, \$25,000 of which has been paid prior to the date of this prospectus. We have also agreed to pay for background checks of our senior management up to an amount of \$7,500. In the event that the offering is terminated, any advance expense deposits paid to the underwriters will be returned to the extent that offering expenses are not actually incurred in accordance with FINRA Rule 5110(g)(4)(A). We estimate that the total expenses of this offering, including registration, filing and listing fees, printing fees and legal and accounting expenses, but excluding the underwriting discounts and commissions, will be approximately US\$ .

#### **Representative's Warrants**

Upon the closing of this offering, we have agreed to issue to the representative of the underwriters or its designees warrants to purchase a number of ADSs equal to 2.5% of the ADSs sold by us in this offering, including ADSs (if any) sold upon the exercise of the option to purchase additional ADSs (the "Representative's Warrants"). The Representative's Warrants will have an exercise price equal to \$ per ADS (or 125% of the public offering price per ADS). The Representative's Warrants will be exercisable until the date that is five years after the date of commencement of sales in this offering in compliance with Financial Industry Regulatory Authority, or FINRA, Rule 5110. The Representative's Warrants are also exercisable on a cashless basis. The Representative's Warrants have been deemed compensation by FINRA and are subject to a 180-day lock-up pursuant to FINRA Rule 5110. Except as permitted by Rule 5110, the representative for the underwriters (or permitted assignees under Rule 5110) will not sell, transfer, assign, pledge, or hypothecate the Representative's Warrants or the securities underlying the Representative's Warrants, nor will any of them engage in any hedging, short sale, derivative, put, or call transaction that would result in the effective economic disposition of the option or the underlying securities for a period of 180 days from the commencement of sales under this prospectus. The exercise price and number of securities upon exercise of the Representative's Warrants may be adjusted in certain circumstances including in the event of a share dividend, extraordinary cash dividend or our recapitalization, reorganization, merger or consolidation. However, the Representative's Warrant exercise price or underlying ADSs will not be adjusted for issuances of ADSs at a price below the Representative's Warrant exercise price. The Representative's Warrants and the ordinary shares underlying the ADSs issuable upon exercise thereof are registered on the registration statement of which this prospectus forms a part.

#### **Discretionary Accounts**

The underwriters do not intend to confirm sales of the ADSs offered hereby to any accounts over which they have discretionary authority.

#### **Lock-Up Agreements**

We have agreed that, subject to certain exceptions, we will not, for a period of 180 days after the date of this prospectus, (i) offer, pledge, issue, sell, contract to sell, sell any option or contract to purchase, purchase any option or contract to sell, grant any option, right or warrant to purchase, lend or otherwise transfer or dispose of, directly or indirectly, or submit to, or file with, the Securities and Exchange Commission a registration statement under the Securities Act relating to, any of our ordinary shares or ADSs or securities convertible into or exercisable or exchangeable for any of our ordinary shares or ADSs, or publicly disclose the intention to undertake any of the foregoing, or (ii) enter into any swap or other arrangement that transfers all or a portion of the economic consequences associated with the ownership of any ordinary shares, ADSs or any such other securities, or establish or increase a put equivalent position or liquidate or decrease a call equivalent position in any ordinary shares, ADSs or any such other securities, or publicly disclose

the intention to enter into any such agreement or transaction or (iii) file or cause to be filed any registration statement relating to the offering of any of our share capital (regardless of whether any of the transactions described in (i) or (ii) above are to be settled by the delivery of ordinary shares, ADSs or such other securities, in cash or otherwise) or publicly disclose the intention to file any such registration statement, without the prior written consent of the representative of the underwriters.

Our directors, officers, and shareholders beneficially holding greater than 5% of our ordinary shares (collectively, the lock-up parties) have agreed that, without the prior written consent of the representative of the underwriters and subject to certain exceptions, they will not, for a period of 180 days after the date of this prospectus, (1) offer, pledge, sell, contract to sell, sell any option or contract to purchase, purchase any option or contract to sell, grant any option, right or warrant to purchase, lend or otherwise transfer or dispose of, directly or indirectly, any of our ordinary shares or ADSs or any securities convertible into or exercisable or exchangeable for our ordinary shares or ADSs, (2) enter into any hedging, swap or other agreement or transaction that transfers, in whole or in part, any of the economic consequences of ownership of the lock-up securities, whether any such transaction described in clause (1) or (2) above is to be settled by delivery of lock-up securities, in cash or otherwise, (3) make any demand for, or exercise any right with respect to, the registration of any lock-up securities, or (4) publicly disclose the intention to do any of the foregoing. Such persons or entities have further acknowledged that these undertakings preclude them from engaging in any hedging or other transactions or arrangements designed or intended, or which could reasonably be expected to lead to or result in, a sale or disposition or transfer of any economic consequences of ownership, in whole or in part, directly or indirectly, of any lock-up securities, whether any such transaction or arrangement would be settled by delivery of lock-up securities, in cash or otherwise.

The representative of the underwriters, in its sole discretion, may release the securities subject to any of the lock-up agreements described above, in whole or in part at any time.

We have further agreed to instruct \_\_\_\_\_, as depository, not to accept any deposit of any ordinary shares or issue any ADSs for 180 days after the date of this prospectus (other than in connection with this offering), unless we instruct the depository otherwise with the prior written consent of the representative of the underwriters. The foregoing does not affect the right of ADS holders to cancel their ADSs and withdraw the underlying ordinary shares.

#### **Right of First Refusal**

We have granted the representative a right of first refusal, for a period of nine (9) months from the closing of this offering, to act as lead or joint-lead investment banker, lead or joint-lead book runner and/or lead or joint placement agent at the representative's discretion, for each and every future public and private equity, equity-linked or debt offering, including all equity linked financings during such nine (9) month period, by us or our successor, or any subsidiary.

#### **Electronic Offer, Sale and Distribution of ADSs**

A prospectus in electronic format may be made available on the websites maintained by one or more underwriters, or selling group members, if any, participating in the offering. The underwriters may agree to allocate a number of ADSs to underwriters and selling group members for sale to their online brokerage account holders. Internet distributions will be allocated by the representative of the underwriters and selling group members that may make Internet distributions on the same basis as other allocations.

#### **Listing**

We have applied to have our ADSs approved for listing on the Nasdaq Capital Market under the symbol "BLTE."

#### **Stabilization**

In connection with this offering, the underwriters may engage in stabilizing transactions, which involves making bids for, purchasing and selling ADSs in the open market for the purpose of preventing or retarding a decline in the market price of the ADSs while this offering is in progress. These stabilizing

transactions may include making short sales of ADSs, which involves the sale by the underwriters of a greater number of ADSs than they are required to purchase in this offering, and purchasing ADSs on the open market to cover positions created by short sales. Short sales may be “covered” shorts, which are short positions in an amount not greater than the underwriters’ option to purchase additional ADSs referred to above, or may be “naked” shorts, which are short positions in excess of that amount. The underwriters may close out any covered short position either by exercising the option to purchase additional ADSs, in whole or in part, or by purchasing ADSs in the open market. In making this determination, the underwriters will consider, among other things, the price of ADSs available for purchase in the open market compared to the price at which the underwriters may purchase ADSs through the option to purchase additional ADSs. A naked short position is more likely to be created if the underwriters are concerned that there may be downward pressure on the price of the ADSs in the open market that could adversely affect investors who purchase in this offering. To the extent that the underwriters create a naked short position, they will purchase ADSs in the open market to cover the position.

The underwriters have advised us that, pursuant to Regulation M of the Securities Act of 1933, they may also engage in other activities that stabilize, maintain or otherwise affect the price of the ADSs, including the imposition of penalty bids. This means that if the representative of the underwriters purchases ADSs in the open market in stabilizing transactions or to cover short sales, the representative can require the underwriters that sold those ADSs as part of this offering to repay the underwriting discount received by them.

These activities may have the effect of raising or maintaining the market price of the ADSs or preventing or retarding a decline in the market price of the ADSs, and, as a result, the price of the ADSs may be higher than the price that otherwise might exist in the open market. If the underwriters commence these activities, they may discontinue them at any time. The underwriters may carry out these transactions on the Nasdaq, in the over-the-counter market or otherwise.

#### **Pricing of the Offering**

Prior to this offering, there has been no public market for our ADSs. The initial public offering price will be determined by negotiations between us and the representative of the underwriters. In determining the initial public offering price, we and the representative of the underwriters expect to consider a number of factors including:

- the information set forth in this prospectus and otherwise available to the representative;
- our prospects and the history and prospects for the industry in which we compete;
- an assessment of our management;
- our prospects for future earnings;
- the general condition of the securities markets at the time of this offering;
- the recent market prices of, and demand for, publicly traded securities of generally comparable companies; and
- other factors deemed relevant by the representative and us.

Neither we nor the underwriters can assure investors that an active trading market will develop for our ADSs, or that the ADSs will trade in the public market at or above the initial public offering price.

#### **Other Relationships**

Certain of the underwriters and their affiliates may provide from time to time certain commercial banking, financial advisory, investment banking and other services for us and our affiliates in the ordinary course of their business, for which they may receive customary fees and commissions. However, we have not yet had, and have no present arrangements with any of the underwriters for any further services.

#### **Selling Restrictions**

No action may be taken in any jurisdiction other than the United States that would permit a public offering of the ADSs or the possession, circulation or distribution of this prospectus in any jurisdiction

where action for that purpose is required. Accordingly, the ADSs may not be offered or sold, directly or indirectly, and neither the prospectus nor any other offering material or advertisements in connection with the ADSs may be distributed or published in or from any country or jurisdiction except under circumstances that will result in compliance with any applicable laws, rules and regulations of any such country or jurisdiction.

Persons into whose possession this prospectus comes are advised to inform themselves about and to observe any restrictions relating to the offering and the distribution of this prospectus. This prospectus does not constitute an offer to sell or a solicitation of an offer to buy any securities offered by this prospectus in any jurisdiction in which such an offer or a solicitation is unlawful.

#### ***Australia***

This document:

- does not constitute a disclosure document or a prospectus under Chapter 6D.2 of the Corporations Act 2001 (Cth), or the Corporations Act;
- has not been, and will not be, lodged with the Australian Securities and Investments Commission, or ASIC, as a disclosure document for the purposes of the Corporations Act and does not purport to include the information required of a disclosure document for the purposes of the Corporations Act; and
- may only be provided in Australia to select investors who are able to demonstrate that they fall within one or more of the categories of investors, available under section 708 of the Corporations Act, or Exempt Investors.

The ADSs may not be directly or indirectly offered for subscription or purchased or sold, and no invitations to subscribe for or buy the ADSs may be issued, and no draft or definitive offering memorandum, advertisement or other offering material relating to any ADSs may be distributed in Australia, except where disclosure to investors is not required under Chapter 6D of the Corporations Act or is otherwise in compliance with all applicable Australian laws and regulations. By submitting an application for the ADSs, you represent and warrant to us that you are an Exempt Investor.

As any offer of ADSs under this document will be made without disclosure in Australia under Chapter 6D.2 of the Corporations Act, the offer of those securities for resale in Australia within 12 months may, under section 707 of the Corporations Act, require disclosure to investors under Chapter 6D.2 if none of the exemptions in section 708 applies to that resale. By applying for the ADSs you undertake to us that you will not, for a period of 12 months from the date of issue of the ADSs, offer, transfer, assign or otherwise alienate those ADSs to investors in Australia except in circumstances where disclosure to investors is not required under Chapter 6D.2 of the Corporations Act or where a compliant disclosure document is prepared and lodged with ASIC.

#### ***Canada***

The ADSs may be sold only to purchasers purchasing, or deemed to be purchasing, as principal that are accredited investors, as defined in National Instrument 45-106 Prospectus Exemptions or subsection 73.3(1) of the Securities Act (Ontario), and are permitted clients, as defined in National Instrument 31-103 Registration Requirements, Exemptions and Ongoing Registrant Obligations. Any resale of the ADSs must be made in accordance with an exemption from, or in a transaction not subject to, the prospectus requirements of applicable securities laws.

Securities legislation in certain provinces or territories of Canada may provide a purchaser with remedies for rescission or damages if this prospectus (including any amendment thereto) contains a misrepresentation, provided that the remedies for rescission or damages are exercised by the purchaser within the time limit prescribed by the securities legislation of the purchaser's province or territory. The purchaser should refer to any applicable provisions of the securities legislation of the purchaser's province or territory for particulars of these rights or consult with a legal advisor.

Pursuant to section 3A.3 of National Instrument 33-105 Underwriting Conflicts (NI 33-105), the underwriters are not required to comply with the disclosure requirements of NI 33-105 regarding underwriter conflicts of interest in connection with this offering.

#### ***Cayman Islands***

This prospectus does not constitute an invitation or offer to the public in the Cayman Islands of the ADSs, whether by way of sale or subscription. The underwriters have not offered or sold, and will not offer or sell, directly or indirectly, any ADSs in the Cayman Islands.

#### ***Dubai International Finance Center, or DIFC***

This document relates to an Exempt Offer in accordance with the Markets Rules 2012 of the Dubai Financial Services Authority, or DFSA. This document is intended for distribution only to persons of a type specified in the Markets Rules 2012 of the DFSA. It must not be delivered to, or relied on by, any other person. The DFSA has no responsibility for reviewing or verifying any documents in connection with Exempt Offers. The DFSA has not approved this prospectus supplement nor taken steps to verify the information set forth herein and has no responsibility for this document. The securities to which this document relates may be illiquid and/or subject to restrictions on their resale. Prospective purchasers of the securities offered should conduct their own due diligence on the securities. If you do not understand the contents of this document you should consult an authorized financial advisor.

In relation to its use in the DIFC, this document is strictly private and confidential and is being distributed to a limited number of investors and must not be provided to any person other than the original recipient, and may not be reproduced or used for any other purpose. The interests in the securities may not be offered or sold directly or indirectly to the public in the DIFC.

#### ***European Economic Area***

In relation to each Member State of the European Economic Area and the United Kingdom, or each a Relevant State, no ADSs have been offered or will be offered pursuant to this offering to the public in that Relevant State prior to the publication of a prospectus in relation to the ADSs which has been approved by the competent authority in that Relevant State or, where appropriate, approved in another Relevant State and notified to the competent authority in that Relevant State, all in accordance with the Prospectus Regulation, except that offers of ADSs may be made to the public in that Relevant State at any time under the following exemptions under the Prospectus Regulation:

- (a) to any legal entity which is a qualified investor as defined under the Prospectus Regulation;
- (b) to fewer than 150 natural or legal persons (other than qualified investors as defined under the Prospectus Regulation), subject to obtaining the prior consent of the underwriters; or
- (c) in any other circumstances falling within Article 1(4) of the Prospectus Regulation,

*provided* that no such offer of ADSs shall require us or any underwriter to publish a prospectus pursuant to Article 3 of the Prospectus Regulation or supplement a prospectus pursuant to Article 23 of the Prospectus Regulation and each person who initially acquires any ADSs or to whom any offer is made will be deemed to have represented, acknowledged and agreed to and with each of the underwriters and us that it is a “qualified investor” within the meaning of Article 2(e) of the Prospectus Regulation. In the case of any ADSs being offered to a financial intermediary as that term is used in the Prospectus Regulation, each such financial intermediary will be deemed to have represented, acknowledged and agreed that the ADSs acquired by it in the offer have not been acquired on a non-discretionary basis on behalf of, nor have they been acquired with a view to their offer or resale to, persons in circumstances which may give rise to an offer of any ADSs to the public other than their offer or resale in a Relevant State to qualified investors as so defined or in circumstances in which the prior consent of the representative of the underwriters has been obtained to each such proposed offer or resale.

For the purposes of this provision, the expression an “offer to the public” in relation to ADSs in any Relevant State means the communication in any form and by any means of sufficient information on the



terms of the offer and any ADSs to be offered so as to enable an investor to decide to purchase or subscribe for any ADSs, and the expression “Prospectus Regulation” means Regulation (EU) 2017/1129.

#### ***Hong Kong***

The ADSs have not been offered or sold and will not be offered or sold in Hong Kong, by means of any document, other than (a) to “professional investors” as defined in the Securities and Futures Ordinance (Cap. 571 of the Laws of Hong Kong), or the SFO, of Hong Kong and any rules made thereunder; or (b) in other circumstances which do not result in the document being a “prospectus” as defined in the Companies (Winding Up and Miscellaneous Provisions) Ordinance (Cap. 32) of Hong Kong, or the CO, or which do not constitute an offer to the public within the meaning of the CO. No advertisement, invitation or document relating to the ADSs has been or may be issued or has been or may be in the possession of any person for the purposes of issue, whether in Hong Kong or elsewhere, which is directed at, or the contents of which are likely to be accessed or read by, the public of Hong Kong (except if permitted to do so under the securities laws of Hong Kong) other than with respect to ADSs which are or are intended to be disposed of only to persons outside Hong Kong or only to “professional investors” as defined in the SFO and any rules made thereunder.

#### ***Israel***

This document does not constitute a prospectus under the Israeli Securities Law, 5728-1968, and has not been filed with or approved by the Israel Securities Authority. In Israel, this prospectus may be distributed only to, and is directed only at, investors listed in the first addendum, or the Addendum, to the Israeli Securities Law, consisting primarily of joint investment in trust funds; provident funds; insurance companies; banks, portfolio managers, investment advisors, members of the Tel Aviv Stock Exchange Ltd., underwriters, each purchasing for their own account; venture capital funds; entities with equity in excess of NIS 50 million and “qualified individuals,” each as defined in the Addendum (as it may be amended from time to time), collectively referred to as qualified investors. Qualified investors shall be required to submit written confirmation that they fall within the scope of the Addendum.

#### ***Japan***

The ADSs have not been and will not be registered pursuant to Article 4, Paragraph 1 of the Financial Instruments and Exchange Act. Accordingly, none of the ADSs nor any interest therein may be offered or sold, directly or indirectly, in Japan or to, or for the benefit of, any “resident” of Japan (which term as used herein means any person resident in Japan, including any corporation or other entity organized under the laws of Japan), or to others for re-offering or resale, directly or indirectly, in Japan or to or for the benefit of a resident of Japan, except pursuant to an exemption from the registration requirements of, and otherwise in compliance with, the Financial Instruments and Exchange Act and any other applicable laws, regulations and ministerial guidelines of Japan in effect at the relevant time.

#### ***Kingdom of Saudi Arabia***

This document may not be distributed in the Kingdom of Saudi Arabia except to such persons as are permitted under the Offers of Securities Regulations as issued by the board of the Saudi Arabian Capital Market Authority, or CMA, pursuant to resolution number 2-11-2004 dated 4 October 2004 as amended by resolution number 1-28-2008, as amended, or the CMA Regulations. The CMA does not make any representation as to the accuracy or completeness of this document and expressly disclaims any liability whatsoever for any loss arising from, or incurred in reliance upon, any part of this document. Prospective purchasers of the securities offered hereby should conduct their own due diligence on the accuracy of the information relating to the securities. If you do not understand the contents of this document, you should consult an authorized financial adviser.

#### ***Korea***

The ADSs have not been and will not be registered under the Financial Investments Services and Capital Markets Act of Korea and the decrees and regulations thereunder, or the FSCMA, and the ADSs have been and will be offered in Korea as a private placement under the FSCMA. None of the ADSs may be

offered, sold or delivered directly or indirectly, or offered or sold to any person for re-offering or resale, directly or indirectly, in Korea or to any resident of Korea except pursuant to the applicable laws and regulations of Korea, including the FSCMA and the Foreign Exchange Transaction Law of Korea and the decrees and regulations thereunder, or the FETL. The ADSs have not been listed on any of securities exchanges in the world including, without limitation, the Korea Exchange in Korea. Furthermore, the purchaser of the ADSs shall comply with all applicable regulatory requirements (including but not limited to requirements under the FETL) in connection with the purchase of the ADSs. By the purchase of the ADSs, the relevant holder thereof will be deemed to represent and warrant that if it is in Korea or is a resident of Korea, it purchased the ADSs pursuant to the applicable laws and regulations of Korea.

#### ***Kuwait***

Unless all necessary approvals from the Kuwait Capital Markets Authority pursuant to Law No. 7 of 2010 Concerning the Establishment of the Capital Markets Authority and Regulating of Securities Activities and the implementing regulations thereto (as amended), and the various resolutions, regulations, instructions and announcements issued from time to time pursuant thereto, or in connection therewith, have been given in relation to the marketing of, and sale of, the ADSs, the ADSs may not be marketed, offered for sale, nor sold in the State of Kuwait. Neither this prospectus (including any related document), nor any of the information contained therein is intended to lead to the conclusion of any contract of whatsoever nature within Kuwait.

#### ***Malaysia***

No prospectus or other offering material or document in connection with the offer and sale of the ADSs has been or will be registered with the Securities Commission of Malaysia, or Commission, for the Commission's approval pursuant to the Capital Markets and Services Act 2007. Accordingly, this prospectus and any other document or material in connection with the offer or sale, or invitation for subscription or purchase, of the ADSs may not be circulated or distributed, nor may the ADSs be offered or sold, or be made the subject of an invitation for subscription or purchase, whether directly or indirectly, to persons in Malaysia other than (i) a closed end fund approved by the Commission; (ii) a holder of a Capital Markets Services Licence; (iii) a person who acquires the ADSs, as principal, if the offer is on terms that the ADSs may only be acquired at a consideration of not less than RM250,000 (or its equivalent in foreign currencies) for each transaction; (iv) an individual whose total net personal assets or total net joint assets with his or her spouse exceeds RM3 million (or its equivalent in foreign currencies), excluding the value of the primary residence of the individual; (v) an individual who has a gross annual income exceeding RM300,000 (or its equivalent in foreign currencies) per annum in the preceding twelve months; (vi) an individual who, jointly with his or her spouse, has a gross annual income of RM400,000 (or its equivalent in foreign currencies), per annum in the preceding twelve months; (vii) a corporation with total net assets exceeding RM10 million (or its equivalent in a foreign currencies) based on the last audited accounts; (viii) a partnership with total net assets exceeding RM10 million (or its equivalent in foreign currencies); (ix) a bank licensee or insurance licensee as defined in the Labuan Financial Services and Securities Act 2010; (x) an Islamic bank licensee or takaful licensee as defined in the Labuan Financial Services and Securities Act 2010; and (xi) any other person as may be specified by the Commission; provided that, in the each of the preceding categories (i) to (xi), the distribution of the ADSs is made by a holder of a Capital Markets Services Licence who carries on the business of dealing in securities. The distribution in Malaysia of this prospectus is subject to Malaysian laws. This prospectus does not constitute and may not be used for the purpose of public offering or an issue, offer for subscription or purchase, invitation to subscribe for or purchase any securities requiring the registration of a prospectus with the Commission under the Capital Markets and Services Act 2007.

#### ***Mexico***

None of the ADSs or the ordinary shares have been or will be registered with the National Securities Registry (Registro Nacional de Valores) maintained by the Mexican National Banking and Securities Commission (Comision Nacional Bancaria y de Valores), or CNBV, of Mexico and, as a result, may not be offered or sold publicly in Mexico. The ADSs and the ordinary shares may only be sold to Mexican institutional and qualified investors, pursuant to the private placement exemption set forth in the Mexican Securities Market Law (Ley del Mercado de Valores). As required under the Mexican Securities Market Law,

the company will give notice to the CNBV of the offering of the securities under the terms set forth herein. Such notice will be submitted to the CNBV to comply with the Mexican Securities Market Law, and for informational purposes only. The delivery to, and receipt by, the CNBV of such notice does not certify the solvency of the company, the investment quality of the securities, or that the information contained in this prospectus or in any prospectus supplement. The company has prepared this prospectus and is solely responsible for its content, and the CNBV has not reviewed or authorized such content.

***People's Republic of China***

This prospectus will not be circulated or distributed in the PRC and the ADSs will not be offered or sold, and will not be offered or sold to any person for re-offering or resale directly or indirectly to any residents of the PRC except pursuant to any applicable laws and regulations of the PRC. Neither this prospectus nor any advertisement or other offering material may be distributed or published in the PRC, except under circumstances that will result in compliance with applicable laws and regulations.

***Singapore***

This prospectus has not been registered as a prospectus with the Monetary Authority of Singapore. Accordingly, the underwriters have not offered or sold any ADSs or caused the ADSs to be made the subject of an invitation for subscription or purchase and will not offer or sell any ADSs or cause the ADSs to be made the subject of an invitation for subscription or purchase, and has not circulated or distributed, nor will it circulate or distribute, this prospectus or any other document or material in connection with the offer or sale, or invitation for subscription or purchase, of the ADSs, whether directly or indirectly, to any person in Singapore other than:

- (a) to an institutional investor (as defined in Section 4A of the Securities and Futures Act (Chapter 289) of Singapore, as modified or amended from time to time, or the SFA) pursuant to Section 274 of the SFA;
- (b) to a relevant person (as defined in Section 275(2) of the SFA) pursuant to Section 275(1) of the SFA, or any person pursuant to Section 275(1A) of the SFA, and in accordance with the conditions specified in Section 275 of the SFA; or
- (c) otherwise pursuant to, and in accordance with the conditions of, any other applicable provision of the SFA.

Where the ADSs are subscribed or purchased under Section 275 of the SFA by a relevant person which is:

- (a) a corporation (which is not an accredited investor (as defined in Section 4A of the SFA)) the sole business of which is to hold investments and the entire share capital of which is owned by one or more individuals, each of whom is an accredited investor; or
- (b) a trust (where the trustee is not an accredited investor) whose sole purpose is to hold investments and each beneficiary of the trust is an individual who is an accredited investor,

securities or securities-based derivatives contracts (each term as defined in Section 2(1) of the SFA) of that corporation or the beneficiaries' rights and interest (howsoever described) in that trust shall not be transferred within six months after that corporation or that trust has acquired the ADSs pursuant to an offer made under Section 275 of the SFA except:

- (i) to an institutional investor or to a relevant person, or to any person arising from an offer referred to in Section 275(1A) or Section 276(4)(i)(B) of the SFA;
- (ii) where no consideration is or will be given for the transfer;
- (iii) where the transfer is by operation of law;
- (iv) as specified in Section 276(7) of the SFA; or

- (v) as specified in Regulation 37A of the Securities and Futures (Offers of Investments) (Securities and Securities-based Derivatives Contracts) Regulations 2018.

***State of Qatar***

The ADSs described in this prospectus have not been, and will not be, offered, sold or delivered, at any time, directly or indirectly in the State of Qatar in a manner that would constitute a public offering. This prospectus has not been, and will not be, registered with or approved by the Qatar Financial Markets Authority or Qatar Central Bank and may not be publicly distributed. This prospectus is intended for the original recipient only and must not be provided to any other person. It is not for general circulation in the State of Qatar and may not be reproduced or used for any other purpose.

***Switzerland***

The ADSs may not be publicly offered in Switzerland and will not be listed on the SIX Swiss Exchange, or SIX, or on any other stock exchange or regulated trading facility in Switzerland. This document does not constitute a prospectus within the meaning of, and has been prepared without regard to the disclosure standards for issuance prospectuses under art. 652a or art. 1156 of the Swiss Code of Obligations or the disclosure standards for listing prospectuses under art. 27 ff. of the SIX Listing Rules or the listing rules of any other stock exchange or regulated trading facility in Switzerland. Neither this document nor any other offering or marketing material relating to the ADSs or the offering may be publicly distributed or otherwise made publicly available in Switzerland.

Neither this document nor any other offering or marketing material relating to the offering, the Company, the ADSs have been or will be filed with or approved by any Swiss regulatory authority. In particular, this document will not be filed with, and the offer of ADSs will not be supervised by, the Swiss Financial Market Supervisory Authority FINMA (FINMA), and the offer of ADSs has not been and will not be authorized under the Swiss Federal Act on Collective Investment Schemes, or CISA. The investor protection afforded to acquirers of interests in collective investment schemes under the CISA does not extend to acquirers of ADSs.

***Taiwan***

The ADSs have not been and will not be registered with the Financial Supervisory Commission of Taiwan pursuant to relevant securities laws and regulations and may not be sold, issued or offered within Taiwan through a public offering or in circumstances which constitutes an offer within the meaning of the Securities and Exchange Act of Taiwan that requires a registration or approval of the Financial Supervisory Commission of Taiwan. No person or entity in Taiwan has been authorized to offer, sell, give advice regarding or otherwise intermediate the offering and sale of the ADSs in Taiwan.

***United Arab Emirates***

The ADSs have not been, and are not being, publicly offered, sold, promoted or advertised in the United Arab Emirates (including the Dubai International Financial Centre) other than in compliance with the laws of the United Arab Emirates (and the Dubai International Financial Centre) governing the issue, offering and sale of securities. Further, this prospectus does not constitute a public offer of securities in the United Arab Emirates (including the Dubai International Financial Centre) and is not intended to be a public offer. This prospectus has not been approved by or filed with the Central Bank of the United Arab Emirates, the Securities and Commodities Authority or the Dubai Financial Services Authority.

***United Kingdom***

The ADSs may not be made in the United Kingdom, except that an offer to the public of any ADSs may be made in the United Kingdom at any time:

- (a) to any legal entity which is a qualified investor as defined under Article 2 of the UK Prospectus Regulation;

- (b) to fewer than 150 natural or legal persons (other than qualified investors as defined under Article 2 of the UK Prospectus Regulation), subject to obtaining the prior consent of the representative for any such offer; or
- (c) in any other circumstances falling within Section 86 of the Financial Services and Markets Act 2000 (as amended, the “FSMA”).

*provided* that no such offer of ADSs shall result in the requirement for the publication by us of a prospectus pursuant to Section 85 of the FSMA or supplement a prospectus pursuant to Article 23 of the UK Prospectus Regulation.

For the purposes of this provision, the expression an “offer to the public” in relation to the any ADSs in the United Kingdom means the communication in any form and by any means of sufficient information on the terms of the offer and the ADSs to be offered so as to enable an investor to decide to purchase or subscribe for the ADSs, and the expression “UK Prospectus Regulation” means Regulation (EU) 2017/1129 as it forms part of domestic law by virtue of the European Union (Withdrawal) Act 2018.

This prospectus is only being distributed to and is only directed at: (1) persons who are outside the United Kingdom; (2) investment professionals falling within Article 19(5) of the Financial Services and Markets Act 2000 (Financial Promotion) Order 2005 (the “Order”); or (3) high net worth companies, and other persons to whom it may lawfully be communicated, falling within Article 49(2)(a) to (ed) of the Order (all such persons falling within (1)-(3) together being referred to as “relevant persons”). The ADSs are only available to, and any invitation, offer or agreement to subscribe, purchase or otherwise acquire the ADSs will be engaged in only with, relevant persons. Any person who is not a relevant person should not act or rely on this prospectus or any of its contents.

**EXPENSES RELATED TO THIS OFFERING**

Set forth below is an itemization of the total expenses, excluding underwriting discounts and commissions, that we expect to incur in connection with this offering. With the exception of the SEC registration fee, the Financial Industry Regulatory Authority, or FINRA, filing fee, and the stock exchange market entry and listing fee, all amounts are estimates.

SEC Registration Fee	US\$
FINRA Filing Fee	
Stock Exchange Market Entry and Listing Fee	
Printing and Engraving Expenses	
Legal Fees and Expenses	
Accounting Fees and Expenses	
Miscellaneous	
<b>Total</b>	<u>US\$</u>

**LEGAL MATTERS**

We are being represented by O'Melveny & Myers LLP with respect to certain legal matters as to United States federal securities and New York State law. The validity of the ordinary shares represented by the ADSs offered in this offering will be passed upon for us by Maples and Calder (Hong Kong) LLP. O'Melveny & Myers LLP may rely upon Maples and Calder (Hong Kong) LLP with respect to matters governed by Cayman Islands law and Commerce & Finance Law Offices with respect to matters governed by PRC law. The underwriters are being represented by Ellenoff Grossman & Schole LLP with respect to certain legal matters as to United States federal securities and New York State law.

**EXPERTS**

The consolidated financial statements of Belite Bio, Inc as of December 31, 2021 and 2020, and for each of the years in the two-year period ended December 31, 2021 have been included herein and in the registration statement in reliance upon the report of Friedman LLP, independent registered public accounting firm, appearing elsewhere herein, and upon the authority of said firm as experts in accounting and auditing.

The office of Friedman LLP is located at One Liberty Plaza, 165 Broadway, 21st Floor, New York, NY 10006.



**WHERE YOU CAN FIND ADDITIONAL INFORMATION**

We have filed a registration statement, including relevant exhibits, with the SEC on Form F-1 under the Securities Act with respect to the underlying ordinary shares represented by the ADSs to be sold in this offering. We have also filed a related registration statement on Form F-6 with the SEC to register the ADSs. This prospectus, which constitutes a part of the registration statement on Form F-1, does not contain all of the information contained in the registration statement. You should read our registration statements and their exhibits and schedules for further information with respect to us and the ADSs.

Immediately upon the effectiveness of the registration statement on Form F-1 of which this prospectus forms a part, we will become subject to periodic reporting and other informational requirements of the Exchange Act as applicable to foreign private issuers. Accordingly, we will be required to file reports, including annual reports on Form 20-F, and other information with the SEC. All information filed with the SEC can be obtained over the internet at the SEC's website at [www.sec.gov](http://www.sec.gov).

**BELITE BIO, INC**  
**INDEX TO THE CONSOLIDATED FINANCIAL STATEMENTS**

	<u>PAGE(S)</u>
<a href="#"><u>REPORT OF INDEPENDENT REGISTERED PUBLIC ACCOUNTING FIRM</u></a>	<a href="#"><u>F-2</u></a>
<a href="#"><u>CONSOLIDATED BALANCE SHEETS AS OF DECEMBER 31, 2020 AND 2021</u></a>	<a href="#"><u>F-3</u></a>
<a href="#"><u>CONSOLIDATED STATEMENTS OF OPERATIONS AND COMPREHENSIVE LOSS FOR THE YEARS ENDED DECEMBER 31, 2020 AND 2021</u></a>	<a href="#"><u>F-4</u></a>
<a href="#"><u>CONSOLIDATED STATEMENTS OF CONVERTIBLE PREFERRED SHARES AND SHAREHOLDERS' DEFICIT FOR THE YEARS ENDED DECEMBER 31, 2020 AND 2021</u></a>	<a href="#"><u>F-5</u></a>
<a href="#"><u>CONSOLIDATED STATEMENTS OF CASH FLOWS FOR THE YEARS ENDED DECEMBER 31, 2020 AND 2021</u></a>	<a href="#"><u>F-6</u></a>
<a href="#"><u>NOTES TO CONSOLIDATED FINANCIAL STATEMENTS</u></a>	<a href="#"><u>F-7</u></a>

**FRIEDMAN LLP<sup>®</sup>**

ACCOUNTANTS AND ADVISORS

**REPORT OF INDEPENDENT REGISTERED PUBLIC ACCOUNTING FIRM**

To the Shareholders and the Board of Directors of Belite Bio, Inc

**Opinion on the Consolidated Financial Statements**

We have audited the accompanying consolidated balance sheets of Belite Bio, Inc (the “Company”) as of December 31, 2021 and 2020, and the related consolidated statements of operations and comprehensive loss, convertible preferred shares and shareholders’ deficit, and cash flows for each of the years in the two year period ended December 31, 2021, and the related notes (collectively referred to as the consolidated financial statements). In our opinion, the consolidated financial statements present fairly, in all material respects, the financial position of the Company as of December 31, 2021 and 2020, and the results of its operations and its cash flows for each of the years in the two-year period ended December 31, 2021, in conformity with accounting principles generally accepted in the United States of America.

**Explanatory Paragraph—Going Concern**

The accompanying consolidated financial statements have been prepared assuming the Company will continue as a going concern. As discussed in Note 2 to the consolidated financial statements, the Company has an accumulated deficit, has incurred recurring losses from operations, has an expectation of continuing operating losses for the foreseeable future, and needs to raise capital to finance its future operation. These factors raise substantial doubt about the Company’s ability to continue as a going concern. Management’s plans in regards to these matters are also described in Note 2. These consolidated financial statements do not include any adjustments that might result from the outcome of these uncertainties.

**Basis for Opinion**

These consolidated financial statements are the responsibility of the Company’s management. Our responsibility is to express an opinion on the Company’s consolidated financial statements based on our audit. We are a public accounting firm registered with the Public Company Accounting Oversight Board (United States) (PCAOB) and are required to be independent with respect to the Company in accordance with the U.S. federal securities laws and the applicable rules and regulations of the Securities and Exchange Commission and the PCAOB.

We conducted our audits in accordance with the standards of the PCAOB. Those standards require that we plan and perform the audit to obtain reasonable assurance about whether the consolidated financial statements are free of material misstatement, whether due to error or fraud. The Company is not required to have, nor were we engaged to perform, an audit of its internal control over financial reporting. As part of our audits, we are required to obtain an understanding of internal control over financial reporting, but not for the purpose of expressing an opinion on the effectiveness of the Company’s internal control over financial reporting. Accordingly, we express no such opinion.

Our audits included performing procedures to assess the risks of material misstatement of the consolidated financial statements, whether due to error or fraud, and performing procedures that respond to those risks. Such procedures included examining, on a test basis, evidence regarding the amounts and disclosures in the consolidated financial statements. Our audits also included evaluating the accounting principles used and significant estimates made by management, as well as evaluating the overall presentation of the consolidated financial statements. We believe that our audits provide a reasonable basis for our opinion.

/s/ Friedman LLP  
Friedman LLP  
We have served as the Company’s auditor since 2021  
New York, New York  
March 15, 2022

**BELITE BIO, INC**  
**CONSOLIDATED BALANCE SHEETS**  
(in thousand US Dollars, except share and per share amounts)

	December 31	
	2020	2021
<b>ASSETS</b>		
<b>Current Assets</b>		
Cash	\$ 25,618	\$ 17,344
Prepayments and other current assets	50	87
<b>Total current assets</b>	<u>25,668</u>	<u>17,431</u>
Property and equipment, net	46	94
Prepayment for property and equipment	20	—
Deferred offering costs	—	815
Security deposits	7	8
<b>TOTAL ASSETS</b>	<u>\$ 25,741</u>	<u>\$ 18,348</u>
<b>LIABILITIES, CONVERTIBLE PREFERRED SHARES AND SHAREHOLDERS' DEFICIT</b>		
<b>Current liabilities</b>		
Other payable due to related parties	\$ 26	\$ 71
Accrued expenses and other liabilities	946	1,564
<b>Total current liabilities</b>	<u>972</u>	<u>1,635</u>
<b>TOTAL LIABILITIES</b>	<u>972</u>	<u>1,635</u>
<b>Commitments and contingencies</b>		
<b>Convertible preferred shares</b>		
Series A convertible preferred shares, US\$0.0001 par value, 2,377,642 shares authorized, issued and outstanding as of December 31, 2020 and 2021	8,806	8,806
Series B convertible preferred shares, US\$0.0001 par value, 5,443,272 shares authorized, issued and outstanding as of December 31, 2020 and 2021	23,000	23,000
<b>Total convertible preferred shares</b>	<u>31,806</u>	<u>31,806</u>
<b>Shareholders' deficit</b>		
Ordinary shares, par value of US\$0.0001 per share; 492,179,086 shares authorized; 9,567,997 and 10,274,403 shares issued and outstanding as of December 31, 2020 and 2021, respectively	1	1
Additional paid-in capital	10,563	12,325
Accumulated other comprehensive loss	(44)	(196)
Accumulated deficit	(17,557)	(27,223)
<b>Total shareholders' deficit</b>	<u>(7,037)</u>	<u>(15,093)</u>
<b>TOTAL LIABILITIES, CONVERTIBLE PREFERRED SHARES AND SHAREHOLDERS' DEFICIT</b>	<u>\$ 25,741</u>	<u>\$ 18,348</u>

The accompanying notes are an integral part of the consolidated financial statements.

**BELITE BIO, INC**  
**CONSOLIDATED STATEMENTS OF OPERATIONS AND COMPREHENSIVE LOSS**  
(in thousand US Dollars, except share and per share amounts)

	For the Years Ended December 31,	
	2020	2021
<b>Expenses</b>		
Research and development	3,688	7,419
General and administrative	2,055	2,378
Total operating expenses	5,743	9,797
<b>Loss from operations</b>	(5,743)	(9,797)
<b>Other income (expense):</b>		
Interest income	12	5
Interest expense	(21)	—
Other income	—	126
Total other (expense) income, net	(9)	131
<b>Loss before income tax</b>	(5,752)	(9,666)
Income tax expense	(1)	—
<b>Net loss</b>	(5,753)	(9,666)
<b>Other comprehensive income (loss)</b>		
Foreign currency translation adjustments, net of nil tax	6	(152)
<b>Total comprehensive loss</b>	\$ (5,747)	\$ (9,818)
<b>Weighted average number of ordinary shares used in per share calculation:</b>		
– Basic and Diluted	8,790,397	9,569,932
<b>Net loss per ordinary share</b>		
– Basic and Diluted	\$ (0.65)	\$ (1.01)

The accompanying notes are an integral part of the consolidated financial statements.

**BELITE BIO, INC**  
**CONSOLIDATED STATEMENTS OF CONVERTIBLE PREFERRED**  
**SHARES AND SHAREHOLDERS' DEFICIT**  
(In thousand US Dollars, except share)

	Convertible Preferred Shares		Ordinary Shares		Additional Paid-in Capital	Accumulated other Comprehensive loss	Accumulated deficit	Total Shareholders' deficit
	Shares	Amount	Shares	Amount				
Balance as of January 1, 2020	—	\$ —	7,840,321	\$ 1	\$ 8,114	\$ (50)	\$ (11,804)	\$ (3,739)
Issuance of ordinary shares	—	—	500,000	—	500	—	—	500
Issuance of ordinary shares upon conversion of other payable due to related parties	—	—	500,000	—	500	—	—	500
Issuance of Series A preferred shares	1,833,892	6,792	—	—	—	—	—	—
Issuance of Series A preferred shares upon conversion of convertible promissory notes	543,750	2,014	—	—	—	—	—	—
Issuance of Series B preferred shares	5,443,272	23,000	—	—	—	—	—	—
Exercise of share options	—	—	727,676	—	86	—	—	86
Share-based compensation expense	—	—	—	—	1,363	—	—	1,363
Net loss	—	—	—	—	—	—	(5,753)	(5,753)
Foreign currency translation adjustment	—	—	—	—	—	6	—	6
<b>Balance as of December 31, 2020</b>	<b>7,820,914</b>	<b>\$31,806</b>	<b>9,567,997</b>	<b>\$ 1</b>	<b>\$ 10,563</b>	<b>\$ (44)</b>	<b>\$ (17,557)</b>	<b>\$ (7,037)</b>
Exercise of share options	—	—	706,406	—	232	—	—	232
Share-based compensation expense	—	—	—	—	1,530	—	—	1,530
Net loss	—	—	—	—	—	—	(9,666)	(9,666)
Foreign currency translation adjustment	—	—	—	—	—	(152)	—	(152)
<b>Balance as of December 31, 2021</b>	<b>7,820,914</b>	<b>\$31,806</b>	<b>10,274,403</b>	<b>\$ 1</b>	<b>\$ 12,325</b>	<b>\$ (196)</b>	<b>\$ (27,223)</b>	<b>\$ (15,093)</b>

The accompanying notes are an integral part of the consolidated financial statements.

**BELITE BIO, INC**  
**CONSOLIDATED STATEMENTS OF CASH FLOWS**  
(In thousand US Dollars)

	For the years ended December 31,	
	2020	2021
<b>Cash flows from operating activities</b>		
Net loss	\$ (5,753)	\$ (9,666)
<b>Adjustments to reconcile net loss to net cash used in operating activities:</b>		
Depreciation	17	30
Share-based compensation expense	1,363	1,530
Gain on disposal of property and equipment	—	(8)
Changes in operating assets and liabilities:		
Other receivables due from related parties	4	—
Prepayments	192	(35)
Other payables due to related parties	(19)	45
Accrued expenses and other liabilities	(254)	632
Security deposits	8	(2)
<b>Net cash used in operating activities</b>	<u>(4,442)</u>	<u>(7,474)</u>
<b>Cash flows from investing activities</b>		
Acquisition of property and equipment	—	(74)
Prepayments for property and equipment	(20)	—
Proceeds from disposal of property and equipment	—	18
<b>Net cash used in investing activities</b>	<u>(20)</u>	<u>(56)</u>
<b>Cash flows from financing activities</b>		
Payments of deferred offering costs	—	(815)
Proceeds from related party loan	131	—
Repayment of related party loan	(2,450)	—
Proceeds from issuance of ordinary shares	500	—
Proceed from issuance of convertible preferred shares	29,792	—
Proceed from exercise of share options	86	232
<b>Net cash used in financing activities</b>	<u>28,059</u>	<u>(583)</u>
Effects of exchange rate on cash	4	(161)
<b>NET (DECREASE) INCREASE IN CASH</b>	<u>23,601</u>	<u>(8,274)</u>
<b>CASH AT BEGINNING OF THE YEAR</b>	<u>2,017</u>	<u>25,618</u>
<b>CASH AT END OF THE PERIOD</b>	<u>\$25,618</u>	<u>\$17,344</u>
<b>SUPPLEMENTAL DISCLOSURE OF CASH FLOW INFORMATION</b>		
Interest paid	19	—
<b>SUPPLEMENTAL DISCLOSURE OF NON-CASH INVESTING</b>		
Conversion of convertible promissory notes and accrued interest into convertible preferred shares	2,014	—
Conversion of other payable due to related parties into ordinary shares	500	—

The accompanying notes are an integral part of the consolidated financial statements.

**BELITE BIO INC****NOTES TO CONSOLIDATED FINANCIAL STATEMENTS****(Amounts in thousands except for number of shares and per share data, unless otherwise noted)****1. ORGANIZATION AND BASIS OF PRESENTATION**

Belite Bio, Inc (“Belite” or the “Company”) was incorporated under the laws of the Cayman Islands on March 27, 2018. The Company and its subsidiaries are engaged in research and development of first-in-class therapeutics targeting significant unmet needs.

In June 2016, the Company’s ultimate controlling shareholder (i.e., the sole shareholder of Belite’s principal shareholder, Lin Bioscience International Ltd.), Lin BioScience, Inc., a public company in Taiwan (stock code: 6696.TW), established Belite Bio Holdings Corp. (formerly known as Lin BioScience Holdings Corporation) and Belite Bio, LLC (formerly known as Lin BioScience, LLC), in Delaware. Belite Bio Holdings Corp. is established as an intermediate holding company and owns 100% equity interests in Belite Bio, LLC, which is mainly engaged in research and development of LBS-008 and LBS-009.

In March 2018, Lin BioScience, Inc., established the Company in the Cayman Islands, as a subsidiary to its wholly-owned subsidiary Lin Bioscience International Ltd., for reorganization purposes.

In June 2018, as part of the reorganization, the Company’s principal shareholder, Lin Bioscience International Ltd., acquired the entire equity interest in Belite Bio Holdings Corp. from Lin BioScience, Inc. and then contributed the entire equity interest in Belite Bio Holdings Corp. to the Company in July 2018, together with other considerations in exchange for the Company’s ordinary shares. Lin Bioscience International Ltd. transferred 1) cash of \$900, 2) assignment of Lin BioScience, Inc.’s rights, title, interests and obligations under the exclusive license agreement by and between Lin BioScience, Inc. and Columbia University and 3) 1,600 shares of Belite Bio Holdings Corp. to the Company in exchange for its 5,340,221 ordinary shares. After above transaction, Belite Bio Holdings Corp. became Belite’s wholly-owned subsidiary, which in turn owns 100% equity interests in Belite Bio, LLC.

Before and after the reorganization, the Company, together with its subsidiaries, is effectively controlled by the same shareholders, and therefore the reorganization is considered a recapitalization of entities under common control in accordance with Accounting Standards Codification (“ASC”) 805-50-25. The consolidation of the Company and its subsidiaries have been accounted for at historical cost in the accompanying consolidated financial statements in accordance with ASC 805-50-45-5.

In August 2018, Belite Bio Holdings Corp. established RBP4 Pty Ltd in Australia as its wholly-owned subsidiary for carrying out clinical trials in Australia and tax refund purposes.

In January and February 2020, the Company closed two rounds of Series A Preferred Share financing and the relevant investors became shareholders of the Company. In December 2020, the Company closed a round of Series B Preferred Share financing and the relevant investors became shareholders of the Company. After the private placements, Lin Bioscience International Ltd. hold 80.10% of the Company’s equity.

In June 2021, the Company established Belite Bio (HK) Limited in Hong Kong as a wholly-owned subsidiary which established Belite Bio (Shanghai) Limited in Shanghai, China in August 2021 for the purpose of carrying out clinical trials in China. As of December 31, 2021, the Company’s principal subsidiaries are as follows:



<b>Subsidiaries</b>	<b>Date of incorporation</b>	<b>Place of incorporation</b>	<b>Ownership</b>	<b>Principal activities</b>
Belite Bio Holdings Corp. ("Belite Holding")	June 10, 2016	The United States of America	100% owned by Belite	Investment holding
Belite Bio, LLC ("Belite USA")	June 10, 2016	The United States of America	100% owned by Belite Holding	Research and development
RBP4 Pty Ltd ("RBP4")	August 13, 2018	Australia	100% owned by Belite Holding	Clinical trial activities
Belite Bio (HK) Limited ("Belite HK")	June 10, 2021	Hong Kong	100% owned by Belite	Investment holding
Belite Bio (Shanghai) Limited ("Belite Shanghai")	August 12, 2021	China	100% owned by Belite HK	Clinical trial activities

## 2. LIQUIDITY AND GOING CONCERN

In accordance with Accounting Standards Update ("ASU") 2014-15, Disclosure of Uncertainties about an Entity's Ability to Continue as a Going Concern (Subtopic 205-40), the Company has evaluated whether there are conditions and events, considered in the aggregate, that raise substantial doubt about the Company's ability to continue as a going concern within one year after the date that the consolidated financial statements are issued.

The Company has incurred recurring negative cash flows since inception and has funded its operations primarily from private placement of equity and debt securities. The Company had an accumulated deficit of approximately \$17.6 million and \$27.2 million as of December 31, 2020 and 2021, respectively. The Company had net losses of approximately \$5.8 million and \$9.7 million for the years ended December 31, 2020 and 2021. As of the issuance date of the consolidated financial statements, the remaining contractual costs expected to be incurred in future periods for the Company's clinical trials in STGD1 is approximately \$10.0 million and the Company is also obligated to make payments to Columbia University in an aggregate amount of up to \$20 million based on achieving specified development and regulatory approval milestones. The Company's ability to continue as a going concern is highly contingent on the ability to raise additional capital for ongoing research and development as the Company expects to continue incurring losses for the foreseeable future.

The Company intends to pursue a public offering of American Depositary Shares to fund future operations. If the Company is unable to complete a public offering for a sufficient amount in a timely manner, it would need to pursue other financing alternatives such as private financing of debt or equity or collaboration agreements. There can be no assurances, however, that the current operating plan will be achieved or that additional funding will be available on terms acceptable to the Company, or at all. If the Company is unable to obtain sufficient funding, it could be required to delay its development efforts, limit activities and reduce research and development costs, which could adversely affect its business prospects.

Based on the Company's recurring losses and negative cash flows from operations since inception, expectation of continuing operating losses and negative cash flows from operations for the foreseeable future, the contractual costs expected to be incurred in future periods and the need to raise additional capital to finance its future operations, the Company's management concluded that there is substantial doubt about the Company's ability to continue as a going concern within one year after the issuance date of the consolidated financial statements.

The accompanying consolidated financial statements do not include any adjustments that might result from the outcome of this uncertainty. Accordingly, the consolidated financial statements have been prepared on a basis that assumes the Company will continue as a going concern and which contemplates the realization of assets and satisfaction of liabilities and commitments in the ordinary course of business.

## 3. SUMMARY OF SIGNIFICANT ACCOUNTING POLICIES

### Basis of presentation

The consolidated financial statements have been prepared in accordance with accounting principles generally accepted in the United States of America ("U.S. GAAP") and applicable rules and regulations of the Securities and Exchange Commission ("SEC").

**Principle of consolidation**

The consolidated financial statements include the accounts of the Company and its subsidiaries. All intercompany accounts and transactions have been eliminated on consolidation.

**Use of estimates**

The preparation of financial statements in conformity with U.S. GAAP requires management to make estimates and assumptions that affect certain reported amounts and disclosures. Significant accounting estimates reflected in the Company's consolidated financial statements include, but are not limited to, valuation of ordinary shares, share options, valuation allowance for deferred income tax assets, useful lives for property and equipment and share-based compensation. Management bases the estimates on historical experience and various other assumptions that are believed to be reasonable, the results of which form the basis for making judgments about the carrying values of assets and liabilities. Accordingly, actual results could differ from those estimates.

**Risk and uncertainties**

The product candidates developed by the Company require approvals from the U.S. Food and Drug Administration ("FDA") or foreign regulatory agencies prior to commercial sales. There can be no assurance that the Company's current and future product candidates will receive the necessary approvals or be commercially successful. If the approval is denied or delayed, it will have a material adverse impact on the business and consolidated financial statements of the Company.

Generally, the industry in which the Company operates subjects the Company to a number of other risks and uncertainties that can affect its operating results and financial condition. Such factors include, but are not limited to: the timing, costs and results of clinical trials and other development activities versus expectations; the ability to manufacture products successfully; competition from products sold or being developed by other companies; the price of, and demand for products once approved; the ability to negotiate favorable licensing or other manufacturing and marketing agreements for its products.

**Fair value measurements**

The Company applies ASC 820, Fair Value Measurements and Disclosures. ASC 820 defines fair value, establishes a framework for measuring fair value and expands disclosures about fair value measurements.

ASC 820 requires disclosures to be provided for fair value measurements. ASC 820 establishes a three-tier fair value hierarchy, which prioritizes the inputs used in measuring fair value as follows:

Level 1 — Observable inputs such as quoted prices for identical instruments in active markets;

Level 2 — Inputs, other than the quoted prices in active markets, that are observable either directly or indirectly;

Level 3 — Unobservable inputs in which there is little or no market data, which require the reporting entity to develop its own assumptions.

ASC 820 describes three main approaches to measuring the fair value of assets and liabilities: (1) market approach; (2) income approach; and (3) cost approach. The market approach uses prices and other relevant information generated from market transactions involving identical or comparable assets or liabilities.

The income approach uses valuation techniques to convert future amounts to a single present value amount. The measurement is based on the value indicated by current market expectations about those future amounts. The cost approach is based on the amount that would currently be required to replace an asset.

Financial instruments of the Company primarily include cash, accrued expenses and other liabilities, other payable due to related parties and convertible preferred shares. Convertible preferred shares were initially recorded at issue price net of issuance costs. The fair value of the other financial instruments closely approximates their fair value due to their short maturities.

**Cash**

Cash consists of demand deposits and time deposits placed with banks and have original maturities of less than three months. All cash is unrestricted as to withdrawal and use.

**Deferred offering costs**

Deferred offering costs consist of legal and other costs incurred through the balance sheet date that are directly related to the Company's initial public offering and that will be charged to shareholder's deficit upon the completion of the initial public offering. Should the initial public offering prove to be unsuccessful, the deferred offering costs, will be charged to operating expense in the consolidated statement of operations and comprehensive loss. During the years ended December 31, 2020 and 2021, the Company incurred nil and \$815 of offering costs, respectively.

**Property and equipment**

Property and equipment are stated at cost less accumulated depreciation and impairment if applicable. Property and equipment consist of machinery and laboratory equipment. Depreciation is computed on a straight-line basis over estimated useful lives which are 5 years.

Repair and maintenance costs are charged to expense as incurred, whereas the costs of betterments that extend the useful life of property and equipment are capitalized as additions to the related assets.

Retirements, sale and disposals of assets are recorded by removing the cost and accumulated depreciation with any resulting gain or loss reflected in the consolidated statements of operations and comprehensive loss.

**Long-lived asset impairment**

The Company evaluates the recoverability of long-lived assets whenever events or changes in circumstances indicate the carrying value may not be fully recoverable. When these events occur, the Company evaluates the recoverability of long-lived assets by comparing the carrying amount of the assets to the future undiscounted cash flows expected to result from the use of the assets and their eventual disposition. If the sum of the expected undiscounted cash flows is less than the carrying amount of the assets, the Company recognizes an impairment loss based on the excess of the carrying amount of the assets over their fair value. Fair value is generally determined by discounting the cash flows expected to be generated by the assets, when the market prices are not readily available. The adjusted carrying amount of the assets become new cost basis and are depreciated over the assets' remaining useful lives. No impairment loss was recorded for the year ended December 31, 2020 and 2021.

**Segment reporting**

In accordance with ASC 280, Segment Reporting, the Company's chief operating decision maker ("CODM") has been identified as the Chief Executive Officer. The Company's CODM reviews the consolidated results of operations when making decisions about allocating resources and assessing performance of the Company. The Company operates and manages its business as a single segment. The Company does not distinguish between markets for the purpose of making decisions about resources allocation and performance assessment. Hence, the Company has only one operating segment and one reportable segment. No geographical segments are presented as substantially all the Company's long-lived assets are located in Australia.

**Research and development expenses**

Research and development expenses primarily include (1) payroll, share-based compensation and other related costs of personnel engaged in research and development activities, (2) in-licensed patent rights fee of exclusive development rights of drugs granted to the Company, (3) costs related to preclinical testing of the Company's technologies and clinical trials such as payments to contract research organizations ("CRO") and contract manufacturing organizations ("CMO"), investigators and clinical trial sites that conduct the clinical studies; (4) costs to develop the product candidates, including raw materials and supplies, product testing, depreciation, and facility related expenses, (5) other research and development expenses. Research and

development expenses are charged to expense as incurred when these expenditures relate to the Company's research and development services and have no alternative future uses in accordance with ASC 730, Research and Development.

#### **Accrued research and development expenses**

The Company is required to estimate its expenses resulting from its obligations under contracts with vendors, consultants and CROs, in connection with conducting research and development activities. The financial terms of these contracts are subject to negotiations, which vary from contract to contract and may result in payment flows that do not match the periods over which the services are provided under such contracts. The Company reflects research and development expenses in the consolidated financial statements by matching those expenses with the period in which services and efforts are expended. The Company account for these expenses according to the progress of the preclinical or clinical study as measured by the timing of various aspects of the study or related activities and determine accrual estimates through review of the underlying contracts along with discussions with research and other key personnel as to the progress of studies, or other services being conducted. During the course of a study, the Company adjusts its rate of expense recognition if actual results differ from its estimates. Estimates for accrued research and development expenses are classified as accrued expenses on the accompanying consolidated balance sheet.

As of December 31, 2021, the Company has several ongoing clinical studies in various clinical trial stages. The contracts with CRO and CMO are generally cancellable, with notice, at the Company's option. The Company did not record any accrued expenses related to cancellation of CRO or CMO contracts as of December 31, 2020 and 2021 as the Company did not have any plan to cancel the existing CRO or CMO contracts.

#### **Leases**

Leases are classified at the inception date as either a capital lease or an operating lease. The Company assesses a lease to be a capital lease if any of the following conditions exists: a) ownership is transferred to the lessee by the end of the lease term, b) there is a bargain purchase option, c) the lease term is at least 75% of the property's estimated remaining economic life or d) the present value of the minimum lease payments at the beginning of the lease term is 90% or more of the fair value of the leased property to the lessor at the inception date. A capital lease is accounted for as if there was an acquisition of an asset and an incurrence of an obligation at the inception of the lease. The Company had no capital leases for the years presented.

All other leases are accounted for as operating leases wherein rental payments are expensed on a straight-line basis over their respective lease terms. The lease term begins on the date of initial possession of the leased property for purpose of recognizing lease expense on straight-line basis over the term of the lease.

#### **Income tax**

The Company accounts for income taxes under the liability method. Under the liability method, deferred income tax assets and liabilities are determined based on the differences between the financial reporting and income tax bases of assets and liabilities and are measured using the tax income rates that will be in effect when the differences are expected to reverse. A valuation allowance is recorded if it is more likely than not that some portion or all of a deferred income tax assets will not be realized in the foreseeable future.

The Company evaluates its uncertain tax positions using the provisions of ASC 740-10, Income Taxes, which prescribes a recognition threshold that a tax position is required to meet before being recognized in the financial statements. The Company recognizes in the financial statements the benefit of a tax position which is "more likely than not" to be sustained under examination based solely on the technical merits of the position assuming a review by tax authorities having all relevant information. Tax positions that meet the recognition threshold are measured using a cumulative probability approach, at the largest amount of tax benefit that has a greater than fifty percent likelihood of being realized upon settlement. It is the Company's policy to recognize interest and penalties related to unrecognized tax benefits, if any, as a component of income tax expense.

### Convertible preferred shares

The preferred shares are redeemable by the holders upon a liquidation event, including a deemed liquidation event, which outside the sole control of the Company, and as such are presented as mezzanine equity. In accordance with ASC 480-10-S99, each issuance of the convertible preferred shares should be recognized at the issuance date fair value, net of issuance costs. The Company did not incur material issuance cost for any preferred shares issued. The non-cumulative undeclared dividends are not recorded in the consolidated balance sheet as the Company does not have the obligation to pay the cumulative dividend before it is declared by the board of directors.

The Company assesses whether an amendment to the terms of its convertible preferred shares is an extinguishment or a modification using the fair value model. When convertible preferred shares are extinguished, the difference between the fair value of the consideration transferred to the convertible preferred shareholders and the carrying amount of the convertible preferred shares (net of issuance costs) is treated as deemed dividends to the preferred shareholders.

### Loss per share

Basic loss per ordinary share is computed by dividing net loss attributable to ordinary shareholders by weighted average number of ordinary shares outstanding during the period.

The Company uses the two-class method whereby net loss is allocated between ordinary shares and other participating securities based on dividends declared (or accumulated) and participating rights in undistributed earnings as if all the earnings for the reporting period had been distributed. The Company's convertible preferred shares are participating securities as the preferred shares are entitled to receive dividends or distributions on an as converted basis. During periods of loss, the Company allocates no loss to participating securities because the holders of convertible preferred shares have no contractual obligation to share in the losses of the Company.

Diluted net loss per share is calculated by dividing net loss attributable to ordinary shareholders, as adjusted for the effect of dilutive ordinary equivalent shares, if any, by the weighted average number of ordinary and dilutive ordinary equivalent shares outstanding during the period. Ordinary equivalent shares include ordinary shares issuable upon the conversion of the convertible preferred shares using the if-converted method, and ordinary shares issuable upon the exercise of share options, using the treasury stock method. Ordinary share equivalents are excluded from the computation of diluted earnings per share if their effects are anti-dilutive. For the periods presented herein, the computation of basic net loss per share using the two-class method is not applicable as the Company is in a net loss position and the participating securities do not have contractual rights and obligations to share in the losses of the Company.

### Share-based compensation

#### *Awards Granted to Employees*

The Company grants share options to eligible employees, management and directors and accounts for these share-based awards in accordance with ASC 718 Compensation-Stock Compensation. Employees' share-based awards are measured at the grant date fair value of the awards and recognized as expenses a) immediately at grant date if no vesting conditions are required; or b) using graded vesting method over the requisite service period, which is the vesting period, on a straight-line basis; c) for share-based awards granted with performance condition, using graded vesting method over the period based on the expected milestone achievement dates. Share-based compensation expense is recorded in research and development and general and administrative expenses based on the classification of the work performed by the grantees.

The Company's determination of the fair value of share option on the date of grant utilized the Binominal Option Pricing Model with the assistance of an independent third-party valuation firm. Grant date fair value was impacted by Belite's ordinary share price as well as changes in assumptions regarding a number of subjective variables which included, but were not limited to, the expected term that options remained outstanding, the expected ordinary share price volatility over the term of the option awards, risk-free interest rates, and expected dividends.

To the extent the required vesting conditions are not met resulting in the forfeiture of the share-based awards, previously recognized compensation expense relating to those awards are reversed.

#### *Awards Granted to Non-Employees*

The Company has accounted for equity instruments issued to non-employees in accordance with ASU No. 2018-07, Compensation — Stock Compensation (Topic 718): Improvements to Nonemployee Share-Based Payment Accounting.

The Company recognizes share-based compensation cost for equity awards to non-employees with a performance condition at the fixed fair value on date of grant over the period based on the expected milestone achievement dates as the derived service period (usually the vesting period), on a straight-line basis. The Company considers the probable outcome of that performance condition when determines share-based compensation expenses and will recognize a cumulative true-up adjustment if the probability of the conditions has changed.

#### **Translation of foreign currency financial statements**

The functional currency is the local currency of the respective entities. The United States dollar (“\$”) is the functional currency of the Company’s entities incorporated in the Cayman Islands, the United States and Hong Kong; the functional currency of the Company’s Australia subsidiary and Shanghai subsidiary are Australian dollar (“AU\$”) and Renminbi (“RMB”), respectively.

The reporting currency of the Company is the United States dollar. Accordingly, the financial statements of the foreign subsidiaries are translated at the following exchange rates: assets and liabilities — current rate on balance sheet date; shareholders’ equity — historical rate; income and expenses — weighted average rate during the year. The resulting translation adjustment is reflected in the accumulated other comprehensive loss.

Transactions denominated in other than the functional currencies are recorded at the rate of exchange in effect when the transaction occurs. Gains or losses, resulting from the application of different foreign exchange rates when cash in foreign currency is converted into the entities’ functional currency, or when foreign currency receivable and payable are settled, are credited or charged to income in the period of conversion or settlement. At year-end, the balances of foreign currency monetary assets and liabilities are recorded based on prevailing exchange rates and any resulting gains or losses are included in the consolidated statements of comprehensive loss.

#### **Comprehensive loss**

Comprehensive loss represents net loss plus the results of certain changes in shareholders’ deficit during a period from non-owner sources.

Comprehensive loss is defined as the changes in equity of the Company during a period from transactions and other events and circumstances excluding transactions resulting from investments by owners and distributions to owners. Among other disclosures, ASC 220, Comprehensive Income, requires that all items that are required to be recognized under current accounting standards as components of comprehensive loss be reported in a financial statement that is displayed with the same prominence as other financial statements. For each of the years presented, the Company’s comprehensive loss includes net loss and foreign currency translation adjustments, which are presented in the consolidated statements of comprehensive loss.

**Concentration of risks***Concentration of suppliers*

The following suppliers accounted for 10% or more of research and development expenses for the years ended December 31, 2020 and 2021:

Supplier	2020	2021
A	\$ *	\$2,385
B	*	1,213
C	776	765
D	1,187	*
E	448	*
F	442	*
G	423	*

\* Represents less than 10% of research and development expenses for the years ended December 31, 2020 and 2021.

*Concentration of credit risk*

As of December 31, 2020 and 2021, the aggregate amount of cash of US\$ 22,027 and US\$ 9,973 respectively, were held at major financial institutions located in the Republic of China (“R.O.C.” or “Taiwan”), and US\$ 3,591 and US\$ 7,371, respectively, were deposited with major financial institutions located outside the R.O.C.. These financial institutions are of high credit quality and management continually monitors the credit worthiness of these financial institutions.

**Recent Accounting Pronouncements**

In February 2016, the FASB issued ASU 2016-02, Leases (Topic 842), which requires lessees to recognize a right-of-use asset and lease liability on the balance sheet for all leases, including operating leases, with a term in excess of 12 months. The guidance also expands the quantitative and qualitative disclosure requirements. In July 2018, the FASB issued updates to the lease standard making transition requirements less burdensome. The update provides an option to apply the transition provisions of the new standard at its adoption date instead of at the earliest comparative period presented in the Company’s financial statements. The new guidance requires the lessee to record operating leases on the balance sheet with a right-of-use asset and corresponding liability for future payment obligations. FASB further issued ASU 2018-11 “Target Improvement” and ASU 2018-20 “Narrow-scope Improvements for Lessors.” In June 2020, the FASB issued ASU No. 2020-05, “Revenue from Contracts with Customers (Topic 606) and

Leases (Topic 842) Effective Dates for Certain Entities” (“ASU 2020-05”) in response to the ongoing impacts to businesses in response to the coronavirus (COVID-19) pandemic. ASU 2020-05 provides a limited deferral of the effective dates for implementing previously issued ASU 842 to give some relief to businesses and the difficulties they are facing during the pandemic. ASU 2020-05 affects entities in the “all other” category and public Not-For-Profit entities that have not gone into effect yet regarding ASU 2016-02, Leases

(Topic 842). Entities in the “all other” category may defer to fiscal years beginning after December 15, 2021, and interim periods within fiscal years beginning after December 15, 2022. The adoption of this amendment is not expected to have a material impact on the Company’s consolidated financial statements.

In December 2019, the FASB issued an accounting update which eliminated certain exceptions to the general principles in ASC 740, such as recognizing deferred taxes for equity investments, the incremental approach to performing intra-period tax allocation, and calculating income taxes in interim periods. The standard also simplified income tax accounting for franchise taxes that are partially based on income, transactions with a government that result in a step-up in the tax basis of goodwill, separate financial statements of legal entities that are not subject to tax, and enacted changes in tax laws in interim period.

This amendment is effective for fiscal years beginning after December 15, 2020. Early adoption is permitted. The adoption of this amendment is not expected to have a material impact on the Company's consolidated financial statements.

Except as mentioned above, the Company does not believe other recently issued but not yet effective accounting standards, if currently adopted, would have a material effect on the Company's consolidated balance sheets, statements of operations and comprehensive loss and statements of cash flows.

#### 4. PREPAYMENTS AND OTHER CURRENT ASSETS

Prepayments and other current assets consist of the following:

	<u>As of December 31,</u>	
	<u>2020</u>	<u>2021</u>
Prepayments		
– Prepayments for other services	\$10	\$64
Deductible value-added tax input	40	23
	<u>\$50</u>	<u>\$87</u>

#### 5. PROPERTY AND EQUIPMENT, NET

Property and equipment consist of the following:

	<u>As of December 31,</u>	
	<u>2020</u>	<u>2021</u>
Laboratory equipment	\$ 92	\$141
Less: accumulated depreciation	(46)	(47)
Total	<u>\$ 46</u>	<u>\$ 94</u>

Depreciation expenses recognized during the years ended December 31, 2020 and 2021, were approximately \$17 and \$30, respectively.

#### 6. ACCRUED EXPENSES AND OTHER CURRENT LIABILITIES

Accrued expenses and other current liabilities consist of the following:

	<u>As of December 31,</u>	
	<u>2020</u>	<u>2021</u>
Research and development	\$488	\$ 741
Legal and consulting	266	525
License royalties	187	147
Other	5	151
	<u>\$946</u>	<u>\$1,564</u>

#### 7. CONVERTIBLE PREFERRED SHARES

In January and February 2020, the Company issued 2,377,642 shares of Series A convertible preferred shares ("Series A Preferred Shares") with a par value \$0.0001 per share at \$3.7036 per share for a total consideration of (i) cash \$6,792 and (ii) notes principal plus unpaid interests \$2,014 in convertible promissory notes issued in October, 2019.

In December 2020, the Company issued 5,443,272 shares of Series B convertible preferred shares ("Series B Preferred Shares") with a par value \$0.0001 per share to a group of investors at \$ 4.2254 per share for a cash consideration of \$23,000. The shareholder agreement therefore was amended and restated to reflect the issuance of Series B in the liquidation preference. Other than above, the rights and obligations for shareholders of Series A Preferred Shares and Series B Preferred Shares are consistent.



Convertible preferred share consisted of the following as of December 31, 2020 and 2021 (in thousands, except share):

	December 31, 2020 and 2021				
	Preferred Shares Authorized	Preferred Shares Issued and Outstanding	Carrying Value	Liquidation Value	Common Stock Issuable Upon Conversion
Series A Preferred Shares	2,377,642	\$2,377,642	\$ 8,806	\$ 8,806	2,377,642
Series B Preferred Shares	5,443,272	5,443,272	23,000	23,000	5,443,272
<b>Total</b>	<b>7,820,914</b>	<b>7,820,914</b>	<b>31,806</b>	<b>31,806</b>	<b>7,820,914</b>

Key terms of the Series A Preferred Shares and Series B Preferred Shares (collectively the “Preferred Shares”) are summarized as follows:

#### **Voting right**

Each Preferred Share has voting rights equivalent to the number of ordinary shares to which it is convertible at the record date. The Preferred Shares shall vote separately as a class with respect to certain specified matters. Otherwise, the preferred shareholders and ordinary shareholders shall vote together as a single class.

#### **Dividends right**

Each holder of the Preferred Shares will be entitled to receive non-cumulative dividends when declared by the Board of Directors prior and in preference to ordinary shareholders. The dividend should be paid at the rate of 6% of the original issue price per share per annum on each Preferred Shares. After the preferential dividends relating to the Preferred Shares have been paid in full or declared and set apart in any fiscal year of the Company, any additional dividends out of funds or assets legally available therefore may be declared in that fiscal year for the Shares and, if such additional dividends are declared, the preferred shareholders shall be entitled to participate on an as converted-basis pro-rata in any dividends or distributions paid to the ordinary shareholders.

#### **Conversion rights**

Each holder of Preferred Shares shall have the right, at such holder’s sole discretion, to convert all or any portion of the Preferred Shares into ordinary shares based on a one-for-one basis at any time. The initial conversion price is the issuance price of Preferred Shares, subject to adjustment in the event of stock splits, share combinations, share dividends and distribution, reorganization, mergers, consolidations, reclassifications, exchanges, substitutions, or dilutive issuance.

The Preferred Shares will be automatically converted into ordinary shares at the then-effective conversion price upon the earlier of (1) the closing of a Qualified Initial Public Offering, or (2) the date specified by written consent or agreement of majority holders of Preferred Shares.

#### **Liquidation preference**

In the event of any liquidation, dissolution or winding up of the Company, either voluntary or involuntary, or any deemed liquidation event as defined in the Company’s articles of association, the holders of Preferred Shares are entitled to receive, prior to any distribution to the holders of ordinary shares, an amount per share equal to the original issue price, plus accrued but unpaid dividends (the “Preference Amount”).

In the event insufficient funds are available to pay in full the Preference Amount in respect of each preferred shareholders, the sequence of liquidation right of all series of preferred shares was as follows:

- (1) Series B Preferred Shares
- (2) Series A Preferred Shares

After the Preference Amount has been paid, any remaining funds or assets legally available for distribution shall be distributed pro rata among the preferred shareholders together with ordinary shares.

## 8. SHARE-BASED COMPENSATION

On December 17, 2019, the Company adopted a share incentive plan (“2019 Plan”). Under the 2019 Plan, the Company’s Board of Directors has approved that a maximum aggregate number of shares that may be issued pursuant to all awards granted shall be 1,960,080. On December 23, 2020, the Company replaced 2019 Plan with the amended and restated share incentive plan (“2020 Plan”) and increased the maximum number of shares issuable to 4,165,310. The terms of the 2019 Plan and 2020 Plan are substantially the same other than the maximum aggregate number of shares the Company may issue under the respective plan.

Share options containing only service conditions granted to each grantee under the 2019 Plan and 2020 Plan will generally be exercisable upon the grantee renders service to the Company in accordance with a stipulated vesting schedule. Grantees are generally subject to a vesting schedule of no longer than three years, under which the grantee earns an entitlement to vest a certain percentage of his option grants at the end of each month or year of completed service. The share option awards shall expire no more than 10 years from their grant dates.

Share options containing both service conditions and performance conditions granted to each grantee under the 2019 Plan and 2020 Plan shall become eligible for vesting upon the occurrence of their applicable performance conditions (including but not limited to the completion of business and operational goals, etc.).

The fair value of options was determined using the Binomial Option Pricing Model, with the assistance from an independent third-party appraiser. The binomial model requires the input of highly subjective assumptions, including the expected volatility, the exercise multiple, the risk-free interest rate and the expected dividend yield. For expected volatility, the Company has made reference to historical volatility of several comparable companies in the same industry. The exercise multiple was estimated as the average ratio of the stock price to the exercise price of when employees would decide to voluntarily exercise their vested share options. As the Company did not have sufficient information of past employee exercise history, the exercise multiple was based on management’s estimation. The risk-free rate for periods within the contractual life of the options is based on the market yield of U.S. Government Notes with a maturity life equal to the remaining maturity life of the options as of the valuation date. The expected dividend yield is based on our expected dividend policy over the contractual life of the options.

The assumptions used to estimate the fair value of the share options on the date of grant are as follows:

	As of December 17, 2019	As of December 23, 2020	As of March 1, 2021
Risk-free interest rate	1.72% – 1.74%	0.51%	0.87%
Expected volatility range	35.50% – 35.72%	36.59%	36.75%
Exercise multiple	2.8	2.8	2.8
Expected dividend yield	—	—	—

A summary of the Company's stock option activity under the plans for the years ended December 31, 2020 and 2021 is presented as follows:

	Number of Options	Weighted Average Exercise Price	Weighted Average Grant Date Fair Value	Weighted Average Remaining Term (Years)	Aggregate Intrinsic Value
Outstanding as of January 1, 2020	1,335,794	\$0.1191	\$2.4720	9.96	3,301
Granted	2,807,381	\$0.4386	\$2.2574	—	—
Exercised	(727,676)	\$0.1191	\$2.4720	—	—
Forfeited or expired	(19,601)	\$0.1191	\$2.4733	—	—
Outstanding as of December 31, 2020	3,395,898	\$0.3832	\$2.2946	9.80	7,834
Granted	41,736	\$4.2254	\$0.4626	—	—
Exercised	(706,406)	\$0.3289	\$2.3311	—	—
Forfeited or expired	(748,667)	\$0.4386	\$2.2574	—	—
Outstanding Options, December 31, 2021	1,982,561	\$0.4626	\$2.2571	8.82	\$4,480
Vested and Expected to Vest Options as of December 31, 2021	844,774	\$0.3935	\$2.3052	8.58	\$1,969
Exercisable Options as of December 31, 2021	356,067	\$0.2291	\$2.4192	7.99	\$ 891

	Years ended December 31,	
	2020	2021
Research and development	\$ 77	\$ 52
General and administrative	1,286	1,478
Total	\$1,363	\$1,530

Total unrecognized employee share-based compensation expense, may be adjusted for actual forfeitures occurring in the future, were \$2,633 and \$771 which are expected to be recognized over a weighted-average period of 1.68 years and 2.77 years as of December 31, 2020 and 2021, respectively.

## 9. INCOME TAX

The Company is not subject to income or other taxes in the Cayman Islands. However, subsidiaries are subject to taxes of the jurisdiction where they are located.

### *Cayman Islands*

The Company is incorporated in the Cayman Islands. Under the current laws of the Cayman Islands, the Company is not subject to tax on income or capital gain. Additionally, the Cayman Islands does not impose a withholding tax on payments of dividends to shareholders.

### *United States*

Belite Bio Holdings Corp. and Belite Bio, LLC are subject to U.S. federal corporate income tax at a rate of 21% and state income tax in California at a rate of 8.84%.

### *Hong Kong*

Belite Bio (HK) Limited is subject to Hong Kong profits tax on the taxable income as reported in the respective statutory financial statements adjusted in accordance with the relevant Hong Kong tax laws. The applicable tax rate in Hong Kong is 8.25% for assessable profits on the first HK\$2 million and 16.5% for any assessable profits in excess.

### *Australia*

RBP4 Pty Ltd is subject to Australia profits tax on the taxable income as reported in their respective statutory financial statements adjusted in accordance with the relevant Australia tax laws. The applicable tax rate in Australia is 30%.

## PRC

Provision for PRC corporate income tax is calculated based on the statutory income tax rate of 25% on the assessable income of Belite Shanghai during the year ended December 31, 2021 in accordance with relevant PRC enterprise income tax legislation, interpretations and practices.

No provision for PRC corporate income tax has been made for the year ended December 31, 2021 as Belite Shanghai had no such assessable profit for the year then ended.

The Company and its subsidiaries file separate income tax returns. The applicable statutory income tax rate in the Cayman Islands was zero for the Company for the years being reported. Reconciliation between the income tax expense computed by applying the statutory tax rate to loss before income tax and the actual provision for income tax is as follows:

	(In Thousands)	
	Years ended December 31,	
	2020	2021
Federal statutory tax rate	21%	21%
State taxes	8.84%	8.84%
Withholding tax	0.02%	0.00%
Research and development credit	(0.03)%	(0.33)%
Non-deductible expenses	(0.27)%	(0.20)%
Changes in valuation allowances	(29.54)%	(29.31)%
Effective tax rate	<u>\$ 0.02%</u>	<u>\$ 0.00%</u>

The deferred income tax assets and liabilities as of December 31, 2020 and 2021 consisted of the following:

	As of December 31,	
	2020	2021
Deferred income tax assets		
Research and development credits	\$ 59	\$ 103
Net operating loss carryforwards	<u>3,687</u>	<u>4,005</u>
	3,746	4,108
Valuation allowance	<u>(3,746)</u>	<u>(4,108)</u>
Total net deferred income tax assets	<u>\$ —</u>	<u>\$ —</u>

Realization of the net deferred tax assets is dependent on factors including future reversals of existing taxable temporary differences and adequate future taxable income, exclusive of reversing deductible temporary differences and tax loss carry forwards. The Company evaluates the potential realization of deferred tax assets on an entity-by-entity basis. As of December 31, 2020 and 2021, the Company and all of its subsidiaries were in cumulative loss position, valuation allowances were provided against deferred tax assets in entities where it was determined it was more likely than not that the benefits of the deferred tax assets will not be realized.

As of December 31, 2020 and 2021, Belite Bio, LLC had U.S. federal and state research and development credit carryforwards of approximately \$59 and \$103, respectively. The U.S. federal research and development credit will expire from 2039 if not utilized, while the state research and development credit will never expire. Utilization of the research and development credits may be subject to significant annual limitation due to the ownership change limitations provided by the U.S. Internal Revenue Code of 1986 and similar provisions in the State of California's tax regulations. The annual limitation may result in the expiration of federal research and development credits before utilization.

As of December 31, 2020 and 2021, the Company's subsidiaries had U.S. net operating loss carryforwards for federal and state tax purposes of approximately \$3,687 and \$4,005, respectively. If not

utilized, the federal and state net operating loss carryforwards incurred before January 1, 2018 will begin to expire in 2036, and the remaining can be carried forward indefinitely but utilization is limited to 80% of the Company's taxable income in any given tax year based on current federal tax laws.

#### 10. AUSTRALIA RESEARCH AND DEVELOPMENT TAX INCENTIVE

The Company's wholly owned subsidiary, RBP4 Pty Ltd, which conducts clinical development activities on behalf of the Company, is eligible under the Australian Research and Development Tax Incentive Program to receive a 43.5% refundable tax incentive from the Australian Taxation Office for qualified research and development expenditures. To be eligible, RBP4 Pty Ltd must have revenue of less than AU\$20 million during the reimbursable period and cannot be controlled by income tax exempt entities. The tax incentive is recognized as a reduction to research and development expense when there is reasonable assurance that the tax incentive will be received, the relevant expenditure has been incurred, and the amount can be reliably measured. For the years ended December 31, 2020, and 2021, \$779 and \$339, respectively, were recorded in the consolidated statements of operations and comprehensive loss.

#### 11. ORDINARY SHARES

As of December 31, 2020 and 2021 the Company was authorized to issue 492,179,086 shares of \$0.0001 par value ordinary shares. Holders of the Company's ordinary shares are entitled to dividends, if and when, declared by the board of directors of the Company and after any convertible preferred share dividends are fully paid. The holder of each share of common stock is entitled to one vote. As of December 31, 2021, no dividends were declared.

#### 12. NET LOSS PER SHARE

Basic and diluted net loss per share for the years ended December 31, 2020 and 2021 are calculated as follows:

	Years ended December 31,	
	2020	2021
Numerator:		
Net loss attributable to ordinary shareholders	\$ (5,753)	\$ (9,666)
Denominator:		
Weighted average number of ordinary shares outstanding – basic and diluted	8,790,397	9,569,932
Net loss per share – basic and diluted	\$ (0.65)	\$ (1.01)

For the years ended December 31, 2020 and 2021, the effects of all outstanding convertible preferred shares and share options have been excluded from the computation of diluted loss per share as their effects would be anti-dilutive.

The potentially dilutive securities that have not been included in the calculation of diluted net loss per share as their inclusion would be anti-dilutive are as follows:

	Years ended December 31,	
	2020	2021
Convertible preferred shares	7,820,914	7,820,914
Outstanding share options	3,395,898	1,982,561
Total	11,216,812	9,803,475

### 13. RELATED PARTY TRANSACTIONS

The table below sets forth the major related parties and their relationships with the Company as of December 31, 2020 and 2021:

<u>Name of related parties</u>	<u>Relationship with the Company</u>
Lin BioScience, Inc.	The ultimate shareholder of the Company
Lin Bioscience International Ltd.	The shareholder of the Company
Lin BioScience Pty Ltd	Controlled by the ultimate shareholder of the Company

The Company and its subsidiaries entered into several research and development services agreements with several related parties, including:

On July 1, 2020, Lin BioScience, Inc. and the Company entered into the LBS-009 R&D services agreement; whereby Lin BioScience, Inc. agreed to provide preclinical studies services for pipeline LBS-009 to the Company. The Company agreed to pay services fees in an amount equal to 110% percent of actual costs for its performance of such development services and to reimburse the actual expenses for transportation, travel and lodging for the performance of such development services. The LBS-009 R&D services agreement terminated on June 30, 2021. For the year ended December 31 2020 and 2021, the Company did not receive any services connected to above agreement.

Lin BioScience, Inc. and the Company also entered into the LBS-008 R&D services agreements on July 1, 2020 and July 1, 2021, whereby Lin BioScience, Inc. agreed to provide certain new drug development services for pipeline LBS-008 to the Company. The Company agreed to pay services fees in an amount equal to 110% percent of actual costs for its performance of such development services and to reimburse the actual expenses for transportation, travel and lodging for the performance of such development services. For the year ended December 31 2020 and 2021, the Company recorded nil and \$183 in research and development expenses, respectively.

In addition to above research and development agreements, the Company and its subsidiaries also entered into certain loan agreements with related parties since 2019, including:

Pursuant to the loan agreements entered into in 2019, Lin Bioscience International Ltd. agreed to provide an interest-free loan on request from time to time for a period of one year from July 2019. In July 2020, Belite Bio, Inc had fully repaid the outstanding amount under the loan agreements with Lin Bioscience International Ltd. For the year ended December 31, 2020, the proceeds received from and repayment made to Lin Bioscience International Ltd. were nil and \$1,180, respectively.

In 2019 and 2020, RBP4 entered into several related party loan agreements with Lin BioScience Pty Ltd, whereby Lin BioScience Pty Ltd, agreed to provide interest-free loans on request from time to time for a period of one year commencing from July 2019. In January 2020, RBP4 had fully repaid the outstanding amount under the loan agreements with Lin BioScience Pty Ltd. For the year ended December 31, 2020, the proceeds received from and repayment made to Lin BioScience Pty Ltd. were \$131 and \$580, respectively.

In 2019 and 2020, Lin BioScience, Inc. entered into a related party funding agreement with RBP4 and the Company. Pursuant to the agreement, Lin BioScience, Inc. agreed to provide loans on request from time to time for a period of one year. In July 2020 the Company and RBP4 had fully repaid the outstanding amount under the loan agreements with Lin BioScience, Inc. For the year ended December 31, 2020, the proceeds received from and repayment made to Lin BioScience, Inc. were nil and \$690, respectively.

(a) *Related party balances*

	<u>As of December 31,</u>	
	<u>2020</u>	<u>2021</u>
<i>Due to related parties</i>		
Lin BioScience, Inc.	<u>\$26</u>	<u>\$71</u>

*(b) Related party transactions*

During the years ended December 31, 2020 and 2021, related party transactions consisted of the following:

	<u>Years ended December 31,</u>	
	<u>2020</u>	<u>2021</u>
<b>Lin BioScience, Inc.:</b>		
Research and Development Expense	\$—	\$183
Professional Service Expense	\$21	\$—
Interest Expense	\$17	\$—

**14. COMMITMENTS AND CONTINGENCIES****License Agreement with Columbia University**

The Company is party to an exclusive license agreement with Columbia University (as amended, the “Columbia License Agreement”), which has been amended five times, most recently as of February 4, 2022, under which the Company licenses specified intellectual property from Columbia University. The patent rights licensed to the Company by Columbia University include issued patents with claims that recite a class of compounds directed to covering the Company’s lead compound, LBS-008, and specifically recite LBS-008. The license agreement requires the Company to make minimum annual royalty payments to Columbia University of specified amounts on each anniversary of the first commercial sale of a licensed product, commencing on the second anniversary of such sale. The Company will also be obligated to pay single-digit earned royalties to Columbia University based on net sales of each licensed product by the Company and its affiliates and sublicensees. The minimum royalty payments will be creditable against the earned royalties accrued during the same calendar year. The license agreement obligates the Company to use commercially reasonable efforts to research, discover, develop and market licensed products for commercial sale and distribution and achieve certain development and regulatory approval milestones within certain timeframes, if certain milestones are achieved. The Company is also obligated to periodically inform Columbia University of its progress in meeting such milestones. The failure to achieve any such milestone would constitute a breach of the Columbia License Agreement. If the Company pays Columbia University the required fee, it will be granted a 6-month extension. As of the date of these financial statements, the Company has complied with the development and regulatory approval milestones under the Columbia License Agreement and requested no extensions. In the event that, after completion of Phase I Trials, there are unforeseen changes in clinical or regulatory development that the Company believes would affect the timely achievement of any milestone, it may request an extension from Columbia University for such milestone, which will not be unreasonably withheld or delayed. In the event that Columbia University does not agree to extend the deadlines to meet the milestones, and the Company is in breach for failure to timely meet the milestones or to make milestone or royalty payments, Columbia University may elect to convert the license to a nonexclusive license without the right to sublicense or initiate legal proceedings against third party patent infringers or terminate the license. The Company is also obligated to make payments to Columbia University in an aggregate amount of up to \$20 million based on achieving specified development and regulatory approval milestones and in an amount of up to \$25 million based on achieving a specified cumulative sales milestone with respect to the first licensed product. In addition, the Company is obligated to pay Columbia University a specified portion of revenue (other than royalties) it receives from sublicensees, and a percentage of revenue in the low double-digits received from any sale of a priority review voucher by us or a sublicensee. The Company cannot reasonably estimate whether, when and in what amount any of such payments shall be made, but believe it is in compliance with the terms of the license. From inception through December 31, 2021, the Company has made a payment of \$1 million to Columbia University resulting from this license agreement, which was triggered by the completion of its Phase I clinical trial.

**Clinical Research Organization (CRO)**

In the course of normal business operations, the Company has agreements with contract service providers to assist in the performance of clinical trial activities. Such agreements are generally cancellable

upon reasonable notice and payment of costs incurred. As of the issuance date of the consolidated financial statements, the remaining contractual costs expected to be incurred in future periods for the Company's clinical trials in STGD1 is approximately \$10.0 million.

**Litigation**

From time to time, the Company may have certain contingent liabilities that arise in the ordinary course of business activities. The Company accrues a liability for such matters when it is probable that future expenditures will be made and such expenditures can be reasonably estimated. The Company is not aware of any current pending legal matters or claims.

**15. SUBSEQUENT EVENTS**

The company evaluated subsequent events and transactions that occurred after the balance sheet date up to January 31, 2022, the date that the financial statements were issued. Based on the review, management did not identify any subsequent events that would have required adjustments or disclosure in the financial statements.



## American Depositary Shares



## Belite Bio, Inc

---

### PROSPECTUS

---

*Book-Running Manager*

## THE BENCHMARK COMPANY

Until \_\_\_\_\_, 2022 (25 days after the date of this prospectus), all dealers that buy, sell or trade these securities, whether or not participating in this offering, may be required to deliver a prospectus. This is in addition to the dealers' obligation to deliver a prospectus when acting as underwriters and with respect to its unsold allotments or subscriptions.

\_\_\_\_\_, 2022

---

---

**PART II**  
**INFORMATION NOT REQUIRED IN PROSPECTUS**

**ITEM 6. INDEMNIFICATION OF DIRECTORS AND OFFICERS.**

Cayman Islands law does not limit the extent to which a company's articles of association may provide for indemnification of officers and directors, except to the extent any such provision may be held by the Cayman Islands courts to be contrary to public policy, such as to provide indemnification against civil fraud or the consequences of committing a crime.

The post-offering memorandum and articles of association that we expect to adopt and to become effective immediately prior to the completion of this offering provide that we shall indemnify our directors and officers (each an indemnified person) against all actions, proceedings, costs, charges, expenses, losses, damages or liabilities incurred or sustained by such indemnified person, other than by reason of such person's own dishonesty, willful default or fraud, in or about the conduct of our company's business or affairs (including as a result of any mistake of judgment) or in the execution or discharge of his duties, powers, authorities or discretions, including, without prejudice to the generality of the foregoing, any costs, expenses, losses or liabilities incurred by such indemnified person in defending (whether successfully or otherwise) any civil proceedings concerning our company or its affairs in any court whether in the Cayman Islands or elsewhere.

Pursuant to the indemnification agreements, the form of which is filed as Exhibit 10.4 to this registration statement, we agree to indemnify our directors and executive officers against certain liabilities and expenses incurred by such persons in connection with claims made by reason of their being such a director or officer.

The underwriting agreement, the form of which is filed as Exhibit 1.1 to this registration statement, also provides indemnification by the underwriters for us and our officers and directors for certain liabilities, including liabilities arising under the Securities Act, but only to the extent that such liabilities are caused by information relating to the underwriters furnished to us in writing expressly for use in this registration statement and certain other disclosure documents.

Insofar as indemnification for liabilities arising under the Securities Act may be permitted to directors, officers or persons controlling us pursuant to the foregoing provisions, we have been informed that in the opinion of the SEC such indemnification is against public policy as expressed in the Securities Act and is therefore unenforceable.

**ITEM 7. RECENT SALES OF UNREGISTERED SECURITIES.**

In the past three years, we have issued the following securities (including options to acquire our ordinary shares) that were not registered under the Securities Act. We believe that each of the following issuances was exempt from registration under the Securities Act pursuant to Section 4(a)(2) of the Securities Act regarding transactions not involving a public offering or in reliance on Regulation S under the Securities Act regarding sales by an issuer in offshore transactions. No underwriters were involved in these issuances of securities.

**Ordinary shares**

On March 27, 2018, we issued 1 ordinary share to Mapcal Limited, which was transferred to Lin Bioscience International Ltd. (our principal shareholder) on March 27, 2018.

We issued to Lin Bioscience International Ltd. (i) 99 ordinary shares for consideration of \$99.9999 on April 13, 2018; (ii) 5,340,221 ordinary shares for consideration of \$900,000 plus assignment of the rights, title, interests and obligations of Lin Bioscience International Ltd. under the exclusive license agreement by and between Lin Bioscience International Ltd. and Columbia University and the transfer of 1,600 shares of Lin BioScience Holdings Corporation (now Belite Bio Holdings Corp.) on July 2, 2018; (iii) 2,500,000 ordinary shares for consideration of \$2,500,000 on August 8, 2018; and (iv) 1,000,000 ordinary shares for

consideration of \$1,000,000 on January 20, 2020. Lin Bioscience International Ltd. is wholly owned by Lin BioScience, Inc., our ultimate controlling shareholder.

On December 31, 2020, we issued 727,676 ordinary shares to the optionees for the options exercised. Specifically, we issued: (i) 367,515 ordinary shares to Yu-Hsin Lin, our Founder, Chief Executive Officer and the Chairman of the Board of Directors; (ii) 257,260 ordinary shares to Hao-Yuan Chuang, our Chief Financial Officer; (iii) 36,751 ordinary shares to Hung-Wei Chen; (iv) 22,050 ordinary shares to Wan-Shan Chen; (v) 22,050 ordinary shares to Ming-Chiu Wu; and (vi) 22,050 ordinary shares to Yun-Ju Huang, in their exercise of options granted.

On December 31, 2021, we issued 706,406 ordinary shares to the optionees for the options exercised. Specifically, we issued: (i) 364,213 ordinary shares to Yu-Hsin Lin, our Founder, Chief Executive Officer and Chairman of the Board of Directors; (ii) 254,950 ordinary shares to Hao-Yuan Chuang, our Chief Financial Officer; (iii) 21,684 ordinary shares to Hung-Wei Chen; (iv) 23,463 ordinary shares to Wan-Shan Chen; (v) 20,243 ordinary shares to Ming-Chiu Wu; and (vi) 21,853 ordinary shares to Yun-Ju Huang, in their exercise of options granted.

#### ***Preferred shares***

On January 31, 2020, we closed a private placement transaction pursuant to which we sold an aggregate of 1,296,963 Series A Preferred Shares for an aggregate consideration of \$2,789,600 in cash and conversion of two convertible promissory notes in the principal amount of \$1,000,000 each.

On February 14, 2020, we issued a total of 1,080,679 Series A Preferred Shares in connection with the second closing of the private placement transaction described above for an aggregate consideration of \$4,002,400 in cash.

On December 24, 2020, we closed a private placement transaction pursuant to which we sold an aggregate of 5,443,272 Series B Preferred Shares for an aggregate consideration of \$23,000,000 in cash.

#### ***Convertible Promissory Note***

On October 22, 2019, we issued a convertible promissory note with the principal amount of US\$1,000,000 with simple interest of 2.5% per annum to each of H&D Asset Management Co., Ltd. and Yun-Ju Huang. Pursuant to the note purchase agreement, the entire convertible promissory notes may be converted, at the option of the note holder, in to the type of equity securities issued in the next equity financing. On January 31, 2020, in conjunction with the first closing of Series A financing, the principal amount and the accrued but unpaid interests (in the total amount of US\$13,835.62) under both convertible promissory notes were converted into Series A Preferred Shares.

#### ***Options***

We have granted options to purchase our ordinary shares to certain of our officers (whether or not a director) or our employees or any of our Affiliates, any member of the Board, or any director of one of our Affiliates, or any eligible individual consultant or advisor. See “Management — Share Incentive Plans”.

<b><u>Securities/Purchaser</u></b>	<b><u>Date of Issuance</u></b>	<b><u>Number of Securities</u></b>	<b><u>Exercise Price</u></b>
<b>Options</b>			
Certain directors, officers and employees	December 17, 2019	Option to purchase up to 1,335,794 ordinary shares	\$0.1191
Certain directors, officers and employees	December 23, 2020	Option to purchase up to 2,807,381 ordinary shares	\$0.4386 <sup>(1)</sup>
Certain key consultants	March 1, 2021	Option to purchase up to 41,736 ordinary shares	\$4.2254

---

Notes:

- (1) This exercise price applies to all options granted on December 23, 2020 except for an option to purchase 6,267 ordinary shares granted to an employee in the US which has an exercise price of \$2.69 per share.

**ITEM 8. EXHIBITS AND FINANCIAL STATEMENT SCHEDULES.**

**(a) Exhibits**

See Exhibit Index beginning on page II-4 of this registration statement.

The agreements included as exhibits to this registration statement contain representations and warranties by each of the parties to the applicable agreement. These representations and warranties were made solely for the benefit of the other parties to the applicable agreement and (i) were not intended to be treated as categorical statements of fact, but rather as a way of allocating the risk to one of the parties if those statements prove to be inaccurate; (ii) may have been qualified in such agreement by disclosure that was made to the other party in connection with the negotiation of the applicable agreement; (iii) may apply contract standards of “materiality” that are different from “materiality” under the applicable securities laws; and (iv) were made only as of the date of the applicable agreement or such other date or dates as may be specified in the agreement.

We acknowledge that, notwithstanding the inclusion of the foregoing cautionary statements, we are responsible for considering whether additional specific disclosure of material information regarding material contractual provisions is required to make the statements in this registration statement not misleading.

**(b) Financial Statement Schedules**

Schedules have been omitted because the information required to be set forth therein is not applicable or is shown in the Consolidated Financial Statements or the Notes thereto.

**ITEM 9. UNDERTAKINGS.**

The undersigned registrant hereby undertakes to provide to the underwriters at the closing specified in the underwriting agreement, certificates in such denominations and registered in such names as required by the underwriters to permit prompt delivery to each purchaser.

Insofar as indemnification for liabilities arising under the Securities Act may be permitted to directors, officers and controlling persons of the registrant pursuant to the provisions described in Item 6, or otherwise, the registrant has been advised that in the opinion of the SEC such indemnification is against public policy as expressed in the Securities Act and is, therefore, unenforceable. In the event that a claim for indemnification against such liabilities (other than the payment by the registrant of expenses incurred or paid by a director, officer or controlling person of the registrant in the successful defense of any action, suit or proceeding) is asserted by such director, officer or controlling person in connection with the securities being registered, the registrant will, unless in the opinion of its counsel the matter has been settled by controlling precedent, submit to a court of appropriate jurisdiction the question whether such indemnification by it is against public policy as expressed in the Securities Act and will be governed by the final adjudication of such issue.

The undersigned registrant hereby undertakes that:

- (1) For purposes of determining any liability under the Securities Act, the information omitted from the form of prospectus filed as part of this registration statement in reliance upon Rule 430A and contained in a form of prospectus filed by the registrant pursuant to Rule 424(b)(1) or (4) or 497(h) under the Securities Act shall be deemed to be part of this registration statement as of the time it was declared effective.

- (2) For the purpose of determining any liability under the Securities Act, each post-effective amendment that contains a form of prospectus shall be deemed to be a new registration statement relating to the securities offered therein, and the offering of such securities at that time shall be deemed to be the initial bona fide offering thereof.

**BELITE BIO, INC**  
**EXHIBIT INDEX**

Exhibit Number	Description of Document
1.1*	Form of Underwriting Agreement
3.1	<a href="#">Second Amended and Restated Memorandum and Articles of Association of the Registrant (as amended on November 1, 2021), as currently in effect</a>
3.2	<a href="#">Third Amended and Restated Memorandum and Articles of Association of the Registrant (effective immediately upon the completion of this offering)</a>
4.1	Registrant's Specimen American Depositary Receipt ( <a href="#">included in Exhibit 4.3</a> )
4.2	<a href="#">Registrant's Specimen Certificate for Ordinary Shares</a>
4.3	<a href="#">Form of Deposit Agreement, among the Registrant, the depository and the holders and beneficial owners of American Depositary Shares issued thereunder</a>
4.4	<a href="#">Amended and Restated Shareholders Agreement by and among Belite Bio, Inc and shareholders of Belite Bio, Inc named therein dated December 23, 2020</a>
4.5	<a href="#">Amendment to Amended and Restated Shareholders Agreement by and among Belite Bio, Inc and shareholders of Belite Bio, Inc named therein dated November 1, 2021</a>
5.1	<a href="#">Opinion of Maples and Calder (Hong Kong) LLP regarding the validity of the ordinary shares being registered and certain Cayman Islands tax matters</a>
8.1	Opinion of Maples and Calder (Hong Kong) LLP regarding certain Cayman Islands tax matters ( <a href="#">included in Exhibit 5.1</a> )
8.2	<a href="#">Opinion of O'Melveny &amp; Myers LLP regarding certain U.S. tax matters</a>
10.1	<a href="#">Belite Bio, Inc Amended and Restated Share Incentive Plan</a>
10.2*	2022 Performance Incentive Plan
10.3	<a href="#">Form of Employment Agreement between the Registrant and its executive officers</a>
10.4	<a href="#">Form of Indemnification Agreement between the Registrant and its directors and executive officers</a>
10.5	<a href="#">Series A Preferred Share Purchase and Note Conversion Agreement by and among Belite Bio, Inc and certain investors of Belite Bio, Inc named therein dated January 21, 2020</a>
10.6	<a href="#">Series B Preferred Share Purchase Agreement by and among Belite Bio, Inc and certain investors of Belite Bio, Inc named therein dated December 23, 2020</a>
10.7 #	<a href="#">Exclusive License Agreement by and between Belite Bio, Inc and The Trustees of Columbia University in The City of New York dated September 13, 2016</a>
10.8	<a href="#">Amendment to Exclusive License Agreement by and between Belite Bio, Inc and The Trustees of Columbia University in The City of New York dated August 15, 2017</a>
10.9	<a href="#">Letter of Consent issued by The Trustees of Columbia University in The City of New York dated May 3, 2018</a>
10.10#	<a href="#">Second Amendment to Exclusive License Agreement by and between Belite Bio, Inc and The Trustees of Columbia University in The City of New York dated March 27, 2019</a>
10.11#	<a href="#">Third Amendment to Exclusive License Agreement by and between Belite Bio, Inc and The Trustees of Columbia University in The City of New York dated October 24, 2019</a>
10.12#	<a href="#">Fourth Amendment to Exclusive License Agreement by and between Belite Bio, Inc and The Trustees of Columbia University in The City of New York dated September 1, 2021</a>
10.13#	<a href="#">Fifth Amendment to Exclusive License Agreement by and between Belite Bio, Inc and The Trustees of Columbia University in The City of New York dated February 4, 2022</a>
10.14	<a href="#">LBS-008 Research and Development Services Agreement by and between Belite Bio, Inc and Lin BioScience, Inc. dated July 1, 2021</a>

<u>Exhibit Number</u>	<u>Description of Document</u>
10.15	<a href="#"><u>First Amendment to LBS-008 Research and Development Services Agreement by and between Belite Bio, Inc and Lin BioScience, Inc. dated February 23, 2022</u></a>
21.1	<a href="#"><u>List of Significant Subsidiaries of the Registrant</u></a>
23.1	<a href="#"><u>Consent of Friedman LLP</u></a>
23.2	Consent of Maples and Calder (Hong Kong) LLP <i>(included in Exhibit 5.1)</i>
23.3	<a href="#"><u>Consent of Commerce &amp; Finance Law Offices</u></a>
24.1	<a href="#"><u>Powers of Attorney (included on signature page)</u></a>
99.1	<a href="#"><u>Code of Business Conduct and Ethics (effective immediately prior to the completion of this offering)</u></a>
99.2	<a href="#"><u>Opinion of Commerce &amp; Finance Law Offices regarding certain PRC law matters</u></a>
99.3	<a href="#"><u>Consent of John M. Longo</u></a>
99.4	<a href="#"><u>Consent of Ita Lu</u></a>
99.5	<a href="#"><u>Consent of Gary C. Biddle</u></a>
107	<a href="#"><u>Filing Fee Table</u></a>

\* To be filed by amendment.

# Portions of this exhibit have been omitted because they are both (i) not material and (ii) would likely cause competitive harm to the Company if publicly disclosed.

**SIGNATURES**

Pursuant to the requirements of the Securities Act of 1933, as amended, the registrant certifies that it has reasonable grounds to believe that it meets all of the requirements for filing on Form F-1 and has duly caused this registration statement to be signed on its behalf by the undersigned, thereunto duly authorized, in Taipei, Taiwan, on April 5, 2022.

**BELITE BIO, INC**

By: /s/ Yu-Hsin Lin

\_\_\_\_\_  
Name: Yu-Hsin Lin

Title: Chief Executive Officer and Chairman

**POWER OF ATTORNEY**

Each person whose signature appears below constitutes and appoints each of Yu-Hsin Lin and Hao-Yuan Chuang as attorneys-in-fact with full power of substitution for him or her in any and all capacities to do any and all acts and all things and to execute any and all instruments which said attorney and agent may deem necessary or desirable to enable the registrant to comply with the Securities Act of 1933, as amended (the "Securities Act"), and any rules, regulations and requirements of the Securities and Exchange Commission thereunder, in connection with the registration under the Securities Act of ordinary shares of the registrant (the "Shares"), including, without limitation, the power and authority to sign the name of each of the undersigned in the capacities indicated below to the Registration Statement on Form F-1 (the "Registration Statement") to be filed with the Securities and Exchange Commission with respect to such Shares, to any and all amendments or supplements to such Registration Statement, whether such amendments or supplements are filed before or after the effective date of such Registration Statement, to any related Registration Statement filed pursuant to Rule 462(b) under the Securities Act, and to any and all instruments or documents filed as part of or in connection with such Registration Statement or any and all amendments thereto, whether such amendments are filed before or after the effective date of such Registration Statement; and each of the undersigned hereby ratifies and confirms all that such attorney and agent shall do or cause to be done by virtue hereof.

Pursuant to the requirements of the Securities Act of 1933, as amended, this Registration Statement has been signed by the following persons in the capacities and on April 5, 2022.

Signature	Title
<u>/s/ Yu-Hsin Lin</u> Name: Yu-Hsin Lin	Chief Executive Officer, Chairman of the Board of Directors (Principal Executive Officer)
<u>/s/ Wan-Shan Chen</u> Name: Wan-Shan Chen	Director
<u>/s/ Hung-Wei Chen</u> Name: Hung-Wei Chen	Director
<u>/s/ Hao-Yuan Chuang</u> Name: Hao-Yuan Chuang	Chief Financial Officer, Director (Principal Financial and Accounting Officer)



**SIGNATURE OF AUTHORIZED REPRESENTATIVE IN THE UNITED STATES**

Pursuant to the Securities Act of 1933, the undersigned, the duly authorized representative in the United States of Belite Bio, Inc has signed this registration statement or amendment thereto in on April 5, 2022.

Authorized U.S. Representative

By: /s/ Donald J. Puglisi

\_\_\_\_\_  
Name: Donald J. Puglisi

Title: Managing Director

THE COMPANIES ACT (2020 REVISION)

OF THE CAYMAN ISLANDS

COMPANY LIMITED BY SHARES

SECOND AMENDED AND RESTATED MEMORANDUM AND ARTICLES

OF

ASSOCIATION

OF

---

Belite Bio, Inc

---

*(adopted by a special resolution passed on 23 December 2020 and effective on 24 December 2020)*

---

**THE COMPANIES ACT (2020 REVISION)**

**OF THE CAYMAN ISLANDS**

**COMPANY LIMITED BY SHARES**

**SECOND AMENDED AND RESTATED MEMORANDUM OF ASSOCIATION**

**OF**

**Belite Bio, Inc**

*(adopted by a special resolution passed on 23 December 2020 and effective on 24 December 2020 )*

1. The name of the Company is Belite Bio, Inc.
2. The Registered Office of the Company shall be at the offices of Maples Corporate Services Limited, PO Box 309, Ugland House, Grand Cayman, KY1-1104, Cayman Islands or at such other place in the Cayman Islands as the Directors may from time to time decide.
3. The objects for which the Company is established are unrestricted and the Company shall have full power and authority to carry out any object not prohibited by the Companies Act (2020 Revision) or as the same may be revised from time to time, or any other law of the Cayman Islands.
4. The Company has unrestricted corporate capacity. Without limitation to the foregoing, as provided by Section 27(2) of the Companies Act (2020 Revision), the Company has and is capable of exercising all the functions of a natural person of full capacity irrespective of any question of corporate benefit. Without in any way limiting the unrestricted nature of its objects, the Company may accept mortgages over land or any other property irrespective of location.
5. Nothing in any of the preceding paragraphs permits the Company to carry on any of the following businesses without being duly licensed, namely:
  - a. the business of a bank or trust company without being licensed in that behalf under the Banks and Trust Companies Act (Revised); or
  - b. insurance business from within the Cayman Islands or the business of an insurance manager, agent, sub-agent or broker without being licensed in that behalf under the Insurance Act (Revised); or

- c. the business of company management without being licensed in that behalf under the Companies Management Act (Revised).
- 6. The liability of each Member is limited to the amount from time to time unpaid on such Member's Shares.
- 7. The authorized share capital of the Company is US\$50,000 divided into (i) 492,179,086 Ordinary Shares of par value US\$0.0001 each, (ii) 2,377,642 Series A Preferred Shares of par value US\$0.0001 each (the "Series A Preferred Shares"), and (iii) 5,443,272 Series B Preferred Shares of par value US\$0.0001 each (the "Series B Preferred Shares").
- 8. If the Company is registered as exempted, its operations will be carried on subject to the provisions of Section 193 of the Companies Act (2020 Revision) and, subject to the provisions of the Companies Act (Revision) and the Articles of Association, it shall have the power to register by way of continuation as a body corporate limited by shares under the laws of any jurisdiction outside the Cayman Islands and to be deregistered in the Cayman Islands.
- 9. Capitalised terms that are not defined in this Memorandum of Association bear the same meaning as those given in the Articles of Association of the Company.

THE COMPANIES ACT (2020 REVISION)

OF THE CAYMAN ISLANDS

COMPANY LIMITED BY SHARES

SECOND AMENDED AND RESTATED ARTICLES OF ASSOCIATION

OF

Belite Bio, Inc

*(adopted by a special resolution passed on 23 December 2020 and effective on 24 December 2020 )*

INTERPRETATION

1. In these Articles Table A in the First Schedule to the Statute does not apply and, unless there is something in the subject or context inconsistent therewith:

<b>“Affiliate”</b>	means, with respect to a Person, any other Person that, directly or indirectly, Controls, is Controlled by or is under common Control with such Person.
<b>“Approved Sale”</b>	shall have the meaning set forth in Article 115.
<b>“Articles”</b>	means these articles of association of the Company as originally formed or as from time to time altered by Special Resolution.
<b>“Auditor”</b>	means the Person for the time being performing the duties of auditor of the Company (if any).
<b>“Automatic Conversion”</b>	shall have the meaning set forth in Article 7.3C hereof.
<b>“Board” or “Board of Directors”</b>	means the board of directors of the Company.
<b>“Business Day”</b>	means any day that is not a Saturday, Sunday, legal holiday or other day on which commercial banks are required or authorized by law to be closed in the PRC, Taiwan, or the United States.

<b>“Charter Documents”</b>	means, with respect to a particular legal entity, the articles or certificate of incorporation, formation or registration (including, if applicable, certificates of change of name), memorandum of association, articles of association, bylaws, articles of organization, limited liability company agreement, trust deed, trust instrument, operating agreement, joint venture agreement, business license, or similar or other constitutive, governing, or charter documents, or equivalent documents, of such entity.
<b>“Company”</b>	means the above named company.
<b>“Control”</b>	of a given Person means the power or authority, whether exercised or not, to direct the business, management and policies of such Person, directly or indirectly, whether through the ownership of voting securities, by contract or otherwise; provided, that such power or authority shall conclusively be presumed to exist upon possession of beneficial ownership or power to direct the vote of more than fifty percent (50%) of the votes entitled to be cast at a meeting of the members or shareholders of such Person or power to control the composition of a majority of the board of directors of such Person. The terms “Controlled” and “Controlling” have meanings correlative to the foregoing.
<b>“Conversion Price”</b>	shall have the meaning set forth in Article 7.3A hereof.
<b>“Conversion Shares”</b>	means Ordinary Shares issuable upon conversion of any Preferred Shares.
<b>“Convertible Securities”</b>	shall have the meaning set forth in Article 7.3E(5)(a)(ii) hereof.
<b>“Deemed Liquidation Event”</b>	means any of the following events:  (1) any consolidation, amalgamation, scheme of arrangement or merger of any Group Company with or into any other Person or other reorganization in which the Members or shareholders of such Group Company immediately prior to such consolidation, amalgamation, merger, scheme of arrangement or reorganization own less than fifty percent (50%) of such Group Company’s voting power in the aggregate immediately after such consolidation, merger, amalgamation, scheme of arrangement or reorganization, or any transaction or series of related transactions to which such Group Company is a party in which in excess of fifty percent (50%) of such Group Company’s voting power is transferred; or

(2) a sale, transfer, lease or other disposition of all or substantially all of the assets of any Group Company (or any series of related transactions resulting in such sale, transfer, lease or other disposition of all or substantially all of the assets of such Group Company);

(3) [Intentionally Left Blank]

**“Director”**

provided that corporate activities taken solely for the purpose of achieving a Qualified IPO shall not in any case be a “Deemed Liquidation Event.”  
means a director serving on the Board for the time being of the Company and shall include an alternate Director appointed in accordance with these Articles.

**“Drag Holders”**

shall have the meaning set forth in Article 115.

**“Electronic Record”**

has the same meaning as given in the Electronic Transactions Act (Revised).

**“Equity Securities”**

means, with respect to any Person that is a legal entity, any and all shares of capital stock, membership interests, units, profits interests, ownership interests, equity interests, registered capital, and other equity securities of such Person, and any right, warrant, option, call, commitment, conversion privilege, preemptive right or other right to acquire any of the foregoing, or security convertible into, exchangeable or exercisable for any of the foregoing, or any contract providing for the acquisition of any of the foregoing.

**“Excepted Issuances”**

shall have the meaning set forth in Article 7.3E(5)(a)(iii) hereof.

<b>“Exempted Distribution”</b>	means (a) a dividend payable solely in Ordinary Shares, (b) the purchase, repurchase or redemption of Ordinary Shares by the Company, and (c) the purchase, repurchase or redemption of the Preferred Shares pursuant to these Articles (including in connection with the conversion of such Preferred Shares into Ordinary Shares).
<b>“Group Company”</b>	means each of the Company and all of its direct or indirect Subsidiaries, and “Group” refers to all of the Group Companies collectively.
<b>“Interested Transaction”</b>	shall have the meaning set forth in Article 79 hereof.
<b>“Majority Preferred Holders”</b>	means the holders of at least a majority of the voting power of the issued and outstanding Preferred Shares (voting together as a single class and on an as converted basis).
<b>“Member”</b>	has the same meaning as in the Statute.
<b>“Memorandum”</b>	means the memorandum of association of the Company, as amended from time to time.
<b>“New Securities”</b>	shall have the meaning set forth in Article 7.3E(5)(a)(iii) hereof.
<b>“Offeror”</b>	shall have the meaning set forth in Article 115.
<b>“Options”</b>	shall have the meaning set forth in Article 7.3E(5)(a)(i) hereof.
<b>“Ordinary Resolution”</b>	means a resolution of a duly constituted general meeting of the Company passed by a simple majority of the votes cast by, or on behalf of, the Members entitled to vote present in person or by proxy and voting at the meeting, or a written resolution as provided in Article 38.
<b>“Ordinary Share”</b>	means an ordinary share of US\$0.0001 par value per share in the capital of the Company having the rights attaching to it as set out herein.
<b>“Original Issue Price”</b>	means the Series A Issue Price and the Series B Issue Price, as the case may be.



<b>“Person”</b>	means any individual, sole proprietorship, partnership, limited partnership, limited liability company, firm, joint venture, estate, trust, unincorporated organization, association, corporation, institution, public benefit corporation, entity or governmental or regulatory authority or other enterprise or entity of any kind or nature.
<b>“PRC”</b>	means the People’s Republic of China, but solely for the purposes hereof excludes the Hong Kong Special Administrative Region, Macau Special Administrative Region and the island of Taiwan.
<b>“Preference Amount”</b>	shall have the meaning set forth in Article 7.2A.
<b>“Preferred Shares”</b>	means the Series A Preferred Shares and the Series B Preferred Shares.
<b>“Qualified IPO”</b>	means a firm commitment underwritten public offering of the Ordinary Shares of the Company (or depositary receipts or depositary shares therefor) in the United States pursuant to an effective registration statement under the United States Securities Act of 1933, as amended, with an offering price (net of underwriting commissions and expenses) that implies a market capitalization of the Company immediately prior to such offering of not less than US\$120,000,000 and that results in gross proceeds to the Company of at least US\$30,000,000, or in a public offering of the Ordinary Shares of the Company (or depositary receipts or depositary shares therefor) in another jurisdiction which results in the Ordinary Shares trading publicly on a recognized international securities exchange approved by the Majority Preferred Holders, so long as such offering satisfies the foregoing market capitalization and gross proceeds requirements.
<b>“Register of Members”</b>	means the register maintained in accordance with the Statute and includes (except where otherwise stated) any duplicate Register of Members.
<b>“Registered Office”</b>	means the registered office for the time being of the Company.

<b>“Series A Issue Price”</b>	means US\$3.7036, as appropriately adjusted for share subdivisions, share dividends, combinations, recapitalizations and similar events with respect to the Series A Preferred Shares.
<b>“Series A Preferred Share”</b>	means a Series A Preferred Share of US\$0.0001 par value per share in the capital of the Company having the rights, preference and privileges attaching to it as set out herein.
<b>“Series A Preference Amount”</b>	shall have the meaning set forth in Article 7.2A.
<b>“Series B Issue Date”</b>	means the date of the first issuance of a Series B Preferred Share.
<b>“Series B Issue Price”</b>	means US\$4.2254, as appropriately adjusted for share subdivisions, share dividends, combinations, recapitalizations and similar events with respect to the Series B Preferred Shares.
<b>“Series B Preferred Share”</b>	means a Series B Preferred Share of US\$0.0001 par value per share in the capital of the Company having the rights, preference and privileges attaching to it as set out herein.
<b>“Series B Preference Amount”</b>	shall have the meaning set forth in Article 7.2A.
<b>“Seal”</b>	means the common seal of the Company and includes every duplicate seal.
<b>“Share” and “Shares”</b>	means a share or shares in the capital of the Company and includes a fraction of a share.
<b>“Shareholders Agreement”</b>	means the Amended and Restated Shareholders Agreement, dated on or about the Series B Issue Date among the Company and certain other parties named therein, as amended from time to time.
<b>“Share Sale”</b>	means a transaction or series of related transactions in which a Person, or a group of related Persons, acquires any Equity Securities of the Company such that, immediately after such transaction or series of related transactions, such Person or group of related Persons holds Equity Securities of the Company representing more than fifty percent (50%) of the issued and outstanding voting power of the Company.

**“Special Resolution”**

has the same meaning as in the Statute.

**“Statute”**

means the Companies Act of the Cayman Islands as amended and every statutory modification or re-enactment thereof for the time being in effect.

**“Subsidiary”**

means, with respect to any given Person, any other Person that is Controlled directly or indirectly by such given Person.

**2. In the Articles:**

- 2.1** words importing the singular number include the plural number and vice versa;
- 2.2** words importing the masculine gender include the feminine gender;
- 2.3** “written” and “in writing” include all modes of representing or reproducing words in visible form, including in the form of an Electronic Record;
- 2.4** references to provisions of any law or regulation shall be construed as references to those provisions as amended, modified, re-enacted or replaced from time to time;
- 2.5** any phrase introduced by the terms “including,” “include,” “in particular” or any similar expression shall be construed as illustrative and shall not limit the sense of the words preceding those terms;
- 2.6** the term “voting power” refers to the number of votes attributable to the Shares (on an as-converted basis) in accordance with the terms of the Memorandum and Articles;
- 2.7** the term “day” means “calendar day” (unless the term “Business Day” is used), and “month” means calendar month;
- 2.8** the phrase “directly or indirectly” means directly, or indirectly through one or more intermediate Persons or through contractual or other arrangements, and “direct or indirect” has the correlative meaning;
- 2.9** references to any documents shall be construed as references to such document as the same may be amended, supplemented or novated from time to time;
- 2.10** all references to dollars or to “US\$” are to currency of the United States of America and all references to RMB are to currency of the PRC (and each shall be deemed to include reference to the equivalent amount in other currencies); and
- 2.11** headings are inserted for reference only and shall be ignored in construing these Articles.

### **COMMENCEMENT OF BUSINESS**

3. The business of the Company may be commenced as soon after incorporation as the Directors shall see fit notwithstanding that any part of the Shares may not have been allotted. The Company shall have perpetual existence until wound up or struck off in accordance with the Statute and these Articles.
4. The Directors may pay, out of the capital or any other monies of the Company, all expenses incurred in or about the formation and establishment of the Company, including the expenses of registration.

### **ISSUE OF SHARES**

5. Subject to the provisions, if any, in the Memorandum (and to any direction that may be given by the Company in a general meeting) and to the provisions of the Memorandum and these Articles (including Article 7) and without prejudice to any rights, preferences and privileges attached to any existing Shares, (a) the Directors may allot, issue, grant options or warrants over or otherwise dispose of the Shares and may designate, allot and issue the Shares from time to time in one or more series/classes. In the event that any Preferred Shares shall be converted pursuant to Article 7.3 hereof, the Preferred Shares so converted shall be cancelled and shall not be re-issuable by the Company. Further, any Preferred Share acquired by the Company by reason of redemption, repurchase, conversion or otherwise shall be cancelled and shall not be re-issuable by the Company.
6. The Company shall not issue Shares to bearer.

### **RIGHTS, PREFERENCES AND PRIVILEGES OF SHARES**

7. Certain rights, preferences and privileges of the Preferred Shares of the Company are as follows:

#### **7.1 Dividends Rights.**

- A. **Preference.** Each holder of a Preferred Share shall be entitled to receive dividends at the rate of six percent (6%) per year of the Original Issue Price per annum for each Share held by such holder, payable out of funds or assets when and as such funds or assets become legally available therefor on parity with each other, prior and in preference to, and satisfied before, any dividend or distribution on any other class or series of shares (except for applicable Exempted Distributions and except for a distribution pursuant to Article 7.2). Such dividends shall be payable only when, as, and if declared by the Board of Directors.
- B. **Restrictions; Participation.** Except for an Exempted Distribution and except for a distribution pursuant to Article 7.2, no dividend or distribution, whether in cash, in property, or in any other shares of the Company, shall be declared, paid, set aside or made with respect to the Ordinary Shares at any time unless (i) all accrued but unpaid dividends on the Preferred Shares set forth in Article 7.1A (if any) have been paid in full, and (ii) a dividend or distribution is likewise declared, paid, set aside or made, respectively, at the same time with respect to each issued and outstanding Preferred Share such that the dividend or distribution declared, paid, set aside or made to the holder thereof shall be equal to the dividend or distribution that such holder would have received pursuant to this Article 7.1B if such Preferred Share had been converted into Ordinary Shares immediately prior to the record date for such dividend or distribution, or if no such record date is established, the date such dividend or distribution is made, and if such share then participated in and the holder thereof received such dividend or distribution.

7.2 **Liquidation Rights.**

A. **Liquidation Preferences.** In the event of any liquidation, dissolution or winding up of the Company, whether voluntary or involuntary, all assets and funds of the Company legally available for distribution to the Members (after satisfaction of all creditors' claims and claims that may be preferred by law) shall be distributed to the Members of the Company as follows:

(1) First, the holders of the Series B Preferred Shares shall be entitled to receive for each Series B Preferred Share held by such holder, on parity with each other and prior and in preference to any distribution of any of the assets or funds of the Company to the holders of any other class or series of shares by reason of their ownership of such shares, the amount equal to 100% of the Series B Issue Price, plus all accrued but unpaid and declared dividends on such Series B Preferred Share (the "**Series B Preference Amount**"). If the assets and funds thus distributed among the holders of the Series B Preferred Shares shall be insufficient to permit the payment to such holders of the full Series B Preference Amount, then the entire assets and funds of the Company legally available for distribution shall be distributed ratably among the holders of the Series B Preferred Shares in proportion to the aggregate Series B Preference Amount each such holder is otherwise entitled to receive pursuant to this subparagraph (1).

(2) Second, if there are any assets or funds remaining after the aggregate Series B Preference Amount has been distributed or paid in full to the applicable holders of Series B Preferred Shares pursuant to subparagraph (1) above, the holders of the Series A Preferred Shares shall be entitled to receive for each Series A Preferred Share held by such holder, on parity with each other and prior and in preference to any distribution of any of the assets or funds of the Company to the holders of Ordinary Shares by reason of their ownership of such shares, the amount equal to 100% of the Series A Issue Price, plus all accrued but unpaid and declared dividends on such Series A Preferred Share (the "**Series A Preference Amount**", together with the Series B Preference Amount, the "**Preference Amount**"). If the assets and funds thus distributed among the holders of the Preferred Shares shall be insufficient to permit the payment to such holders of the full Series A Preference Amount, then the entire assets and funds of the Company legally available for distribution after the aggregate Series B Preference Amount has been distributed or paid in full to the applicable holders of Series B Preferred Shares pursuant to subparagraph (1) above shall be distributed ratably among the holders of the Series A Preferred Shares in proportion to the aggregate Series A Preference Amount each such holder is otherwise entitled to receive pursuant to this subparagraph (2).

(3) Third, if there are any assets or funds remaining after the aggregate Preference Amount has been distributed or paid in full to the applicable holders of the Preferred Shares pursuant to subparagraphs (1) and (2) above, the remaining assets and funds of the Company available for distribution to the Members shall be distributed ratably among the holders of issued and outstanding Ordinary Shares in proportion to the number of issued and outstanding Ordinary Shares held by them.

B. **Deemed Liquidation.** Unless waived in writing by the Majority Preferred Holders, a Deemed Liquidation Event shall be deemed to be a liquidation, dissolution or winding up of the Company for purposes of Article 7.2A, and any proceeds, whether in cash or properties, resulting from a Deemed Liquidation Event shall be distributed in accordance with the terms of Article 7.2A.

C. **Valuation of Properties.** In the event the Company proposes to distribute assets other than cash in connection with any liquidation, dissolution or winding up of the Company pursuant to Article 7.2A or pursuant to a deemed liquidation, dissolution or winding up of the Company pursuant to Article 7.2B, the value of the assets to be distributed to the Members shall be determined in good faith by the Board; provided that any securities not subject to investment letter or similar restrictions on free marketability shall be valued as follows:

(1) If traded on a securities exchange, the value shall be deemed to be the average of the security's closing prices on such exchange over the thirty (30) day period ending one (1) day prior to the distribution;

(2) If traded over-the-counter, the value shall be deemed to be the average of the closing bid prices over the thirty (30) day period ending three (3) days prior to the distribution; and

(3) If there is no active public market, the value shall be the fair market value thereof as determined in good faith by the Board;

provided further that the method of valuation of securities subject to investment letter or other restrictions on free marketability shall be adjusted to make an appropriate discount from the market value determined as above in clauses (1), (2) or (3) to reflect the fair market value thereof as determined in good faith by the Board.

Regardless of the foregoing, the Majority Preferred Holders shall have the right to challenge any determination by the Board of value pursuant to this Article 7.2C, in which case the determination of value shall be made by an independent appraiser selected jointly by the Board and the Majority Preferred Holders, with the cost of such appraisal to be borne by the Company.

- D. **Notices.** In the event that the Company shall propose at any time to consummate a liquidation, dissolution or winding up of the Company or a Deemed Liquidation Event, then, in connection with each such event, subject to any necessary approval required in the Statute and these Articles, the Company shall send to the holders of Preferred Shares at least twenty (20) days prior written notice of the date when the same shall take place; provided, however, that the foregoing notice periods may be shortened or waived with the vote or written consent of the Majority Preferred Holders.
- E. **Enforcement.** In the event the requirements of this Article 7.2 are not complied with, the Company shall forthwith either (i) cause the closing of the applicable transaction to be postponed until such time as the requirements of this Article 7.2 have been complied with, or (ii) cancel such transaction.

### 7.3 **Conversion Rights**

The holders of the Preferred Shares shall have the rights described below with respect to the conversion of the Preferred Shares into Ordinary Shares:

- A. **Conversion Ratio.** Each Preferred Share shall be convertible, at the option of the holder thereof, at any time after the date of issuance of such Preferred Share into such number of fully paid and non-assessable Ordinary Shares as determined by dividing the Original Issue Price by the then-effective Conversion Price (as defined below) for such series of Preferred Shares. The “**Conversion Price**” shall initially be the Original Issue Price, resulting in an initial conversion ratio for the applicable Preferred Shares of 1:1, and shall be subject to adjustment and readjustment from time to time as hereinafter provided.

- B. **Optional Conversion.** Subject to the Statute and these Articles, any Preferred Share may, at the option of the holder thereof, be converted at any time after the date of issuance of such shares, without the payment of any additional consideration, into fully-paid and non-assessable Ordinary Shares based on the applicable Conversion Price at the time in effect for such Share.
- C. **Automatic Conversion.** Each Preferred Share shall automatically be converted, based on the applicable Conversion Price at the time in effect for such Share, without the payment of any additional consideration, into fully-paid and non-assessable Ordinary Shares upon the earlier of (i) the closing of a Qualified IPO, or (ii) the date specified by written consent or agreement of the Majority Preferred Holders. Any conversion pursuant to this Article 7.3C shall be referred to as an “**Automatic Conversion**”.
- D. **Conversion Mechanism.** The conversion hereunder of the Preferred Shares shall be effected in the following manner:
- (1) Except as provided in Articles 7.3D(2) and 7.3D(3) below, before any holder of any Preferred Shares shall be entitled to convert the same into Ordinary Shares, such holder shall surrender the certificate or certificates therefor duly endorsed (or in lieu thereof shall deliver an affidavit of lost certificate and indemnity therefor) (if any), at the office of the Company or of any transfer agent or registered office provider of the Company for such share to be converted and shall give notice to the Company at its principal corporate office, of the election to convert the same and shall state therein the name or names in which the certificate or certificates for Ordinary Shares are to be issued. The Company shall, as soon as practicable thereafter, issue and deliver at such office to such holder of Preferred Shares, or to the nominee or nominees of such holder, a certificate or certificates (if applicable) for the number of Ordinary Shares to which such holder shall be entitled as aforesaid, and such conversion shall be deemed to have been made immediately prior to the close of business on the date of such notice and such surrender of the certificates representing the Preferred Shares, or affidavits of lost certificates, to be converted, the Register of Members of the Company shall be updated accordingly to reflect the same, and the Person or Persons entitled to receive the Ordinary Shares issuable upon such conversion shall be treated for all purposes as the record holder or holders of such Ordinary Shares as of such date.
- (2) If the conversion is in connection with an underwritten public offering of securities, the conversion will be conditioned upon the closing with the underwriter(s) of the sale of securities pursuant to such offering and the Person(s) entitled to receive the Ordinary Shares issuable upon such conversion shall not be deemed to have converted the applicable Preferred Shares until immediately prior to the closing of such sale of securities.



(3) Upon the occurrence of an event of Automatic Conversion, the Company shall give all holders of Preferred Shares to be automatically converted at least ten (10) days' prior written notice of the date fixed (which date shall in the case of a Qualified IPO be the latest practicable date immediately prior to the closing of a Qualified IPO) and the place designated for automatic conversion of all such Preferred Shares pursuant to this Article 7.3D. Such notice shall be given pursuant to Articles 104 through 108 to each record holder of such Preferred Shares at such holder's address appearing on the Register of Members. On or before the date fixed for conversion, each holder of such Preferred Shares shall surrender the applicable certificate or certificates duly endorsed (or in lieu thereof shall deliver an affidavit of lost certificate and indemnity therefor) (if any) for all such shares to the Company at the place designated in such notice. On the date fixed for conversion, the Company shall promptly effect such conversion and update its Register of Members to reflect such conversion, and upon surrender of the certificate or certificates of the shares to be converted duly endorsed (or in lieu thereof upon delivery of an affidavit of lost certificate and indemnity therefor) (if any), the holder thereof shall be entitled to receive certificates (if applicable) for the number of Ordinary Shares into which such Preferred Shares have been converted. All certificates evidencing such Preferred Shares shall, from and after the date of conversion, be deemed to have been retired and cancelled and the Preferred Shares represented thereby converted into Ordinary Shares for all purposes, notwithstanding the failure of the holder or holders thereof to surrender such certificates on or prior to such date.

(4) The Company may effect the conversion of Preferred Shares in any manner available under applicable law, including redeeming or repurchasing the relevant Preferred Shares and applying on behalf of the holders thereof the proceeds thereof towards payment for the new Ordinary Shares. For purposes of the repurchase or redemption, the Company may, subject to the Company being able to pay its debts in the ordinary course of business, make payments out of its capital.

(5) No fractional Ordinary Shares shall be issued upon conversion of any Preferred Shares. In lieu of any fractional shares to which the holder would otherwise be entitled, the Company shall at the discretion of the Board of Directors either (i) pay cash equal to such fraction multiplied by the fair market value for the applicable Preferred Share as determined and approved by the Board of Directors, or (ii) issue one whole Ordinary Share for each fractional share to which the holder would otherwise be entitled.

(6) Upon conversion, all declared but unpaid share dividends on the applicable Preferred Shares shall be paid in shares and all declared but unpaid cash dividends on the applicable Preferred Shares shall be paid either in cash or by the issuance of such number of further Ordinary Shares as equal to the value of such cash amount divided by the applicable Conversion Price, at the option of the holders of the applicable Preferred Shares.

E. **Adjustment of Conversion Price.** The Conversion Price shall be adjusted and re-adjusted from time to time prior to a Qualified IPO as provided below:

(1) **Adjustment for Share Subdivisions and Combinations.** If the Company shall at any time, or from time to time, effect a subdivision of the outstanding Ordinary Shares, the Conversion Price for each series of Preferred Shares in effect immediately prior to such subdivision shall be proportionately decreased. Conversely, if the Company shall at any time, or from time to time, combine the outstanding Ordinary Shares into a smaller number of shares, the Conversion Price for each series of Preferred Shares in effect immediately prior to such combination shall be proportionately increased. Any adjustment under this paragraph shall become effective at the close of business on the date the subdivision or combination becomes effective.

(2) **Adjustment for Ordinary Share Dividends and Distributions.** If the Company makes (or fixes a record date for the determination of holders of Ordinary Shares entitled to receive) a dividend or other distribution to the holders of Ordinary Shares payable in additional Ordinary Shares, the Conversion Price for each series of Preferred Shares then in effect shall be decreased as of the time of such issuance (or in the event such record date is fixed, as of the close of business on such record date) by multiplying such Conversion Price by a fraction (i) the numerator of which is the total number of Ordinary Shares issued and outstanding immediately prior to the time of such issuance or the close of business on such record date, and (ii) the denominator of which is the total number of Ordinary Shares issued and outstanding immediately prior to the time of such issuance or the close of business on such record date plus the number of Ordinary Shares issuable in payment of such dividend or distribution.

(3) **Adjustments for Other Dividends.** If the Company at any time, or from time to time, makes (or fixes a record date for the determination of holders of Ordinary Shares entitled to receive) a dividend or other distribution to the holders of Ordinary Shares payable in securities of the Company other than Ordinary Shares or payable in any other asset or property (other than cash), then, and in each such event, subject to compliance with Article 7.1B and to the extent not duplicative with Article 7.1B, provision shall be made so that, upon conversion of any Preferred Share thereafter, the holder thereof shall receive, in addition to the number of Ordinary Shares issuable thereon, the amount of securities of the Company or other asset or property which the holder of such share would have received in connection with such event had the Preferred Shares been converted into Ordinary Shares immediately prior to such event.

(4) **Adjustments for Reorganizations, Mergers, Consolidations, Reclassifications, Exchanges, Substitutions**. If at any time, or from time to time, any capital reorganization or reclassification of the Ordinary Shares (other than as a result of a share dividend, subdivision, split or combination otherwise treated above) occurs or the Company is consolidated, merged or amalgamated with or into another Person (other than a consolidation, merger or amalgamation treated as a liquidation in Article 7.2B), then in any such event, provision shall be made so that, upon conversion of any Preferred Share thereafter, the holder thereof shall receive the kind and amount of shares and other securities and property which the holder of such shares would have received in connection with such event had the relevant Preferred Shares been converted into Ordinary Shares immediately prior to such event.

(5) **Adjustments to Conversion Price for Dilutive Issuance**.

(a) **Special Definition**. For purpose of this Article 7.3E(5), the following definitions shall apply:

(i) **“Options”** mean rights, options or warrants to subscribe for, purchase or otherwise acquire either Ordinary Shares or Convertible Securities.

(ii) **“Convertible Securities”** shall mean any indebtedness, shares or other securities directly or indirectly convertible into or exchangeable for Ordinary Shares.

(iii) **“New Securities”** shall mean all Ordinary Shares issued (or, pursuant to Article 7.3E(5)(c), deemed to be issued) by the Company after the date on which these Articles are adopted, other than the following issuances (collectively, the **“Excepted Issuances”**):

- (1) Ordinary Shares (or Options exercisable for such Ordinary Shares) (as appropriately adjusted in connection with share splits, share dividends, combinations, recapitalizations and similar events) issued (or issuable pursuant to such Options) to the Group Companies' employees, officers, directors, consultants or any other Persons qualified pursuant to a written employee share option plan or employee equity incentive plan or other similar arrangements duly approved by the Board;

- (2) Ordinary Shares issued or issuable pursuant to a share split or sub-division, share dividend, combination, recapitalization or other similar transaction of the Company, as described in Article 7.3E(1) through Article 7.3E(3);
- (3) any Ordinary Shares issued pursuant to bona fide transactions with commercial lenders or lessors in connection with loans, credit arrangements, equipment financings or similar transactions, each such transaction having been approved by the Board;
- (4) any Ordinary Shares issued pursuant to bona fide transactions with licensors, collaborator or strategic partners in connection with technology licensing, research, development or commercialization collaboration, strategic partnership or similar transactions, each such transaction having been approved by the Board;
- (5) any Equity Securities of the Company issued pursuant to the acquisition of another corporation or entity by the Company by consolidation, merger, purchase of assets, or other reorganization in which the Company acquires, in a single transaction or series of related transactions, all or substantially all assets of such other corporation or entity, or fifty percent (50%) or more of the equity ownership or voting power of such other corporation or entity, in any case, duly approved in accordance with Article 7.4B;
- (6) Ordinary Shares issued upon the conversion of Preferred Shares; and
- (7) any Equity Securities of the Company issued pursuant to a Qualified IPO.

(b) **Waiver of Adjustment.** No adjustment in any Conversion Price shall be made as the result of the issuance or deemed issuance of New Securities if the Company receives written notice from the Majority Preferred Holders agreeing that no such adjustment shall be made as the result of the issuance or deemed issuance of such New Issuance.

(c) **Deemed Issuance of New Securities.** In the event the Company at any time or from time to time after the Series B Issue Date shall issue any Options or Convertible Securities or shall fix a record date for the determination of holders of any series or class of securities entitled to receive any such Options or Convertible Securities, then the maximum number of Ordinary Shares (as set forth in the instrument relating thereto without regard to any provisions contained therein for a subsequent adjustment of such number for anti-dilution adjustments) issuable upon the exercise of such Options or, in the case of Convertible Securities and Options therefor, the conversion or exchange of such Convertible Securities or the exercise of such Options, shall be deemed to be New Securities issued as of the time of such issue or, in case such a record date shall have been fixed, as of the close of business on such record date, provided that in any such case in which New Securities are deemed to be issued:

(i) no further adjustment in the Conversion Price for such series of Preferred Shares shall be made upon the subsequent issue of Convertible Securities or Ordinary Shares upon the exercise of such Options or conversion or exchange of such Convertible Securities or upon the subsequent issue of Options for Convertible Securities or Ordinary Shares;

(ii) if such Options or Convertible Securities by their terms provide, with the passage of time or otherwise, for any change in the consideration payable to the Company, or change in the number of Ordinary Shares issuable, upon the exercise, conversion or exchange thereof, the then effective Conversion Price for such series of Preferred Shares computed upon the original issue thereof (or upon the occurrence of a record date with respect thereto), and any subsequent adjustments based thereon, shall, upon any such change becoming effective, be recomputed to reflect such change insofar as it affects such Options or the rights of conversion or exchange under such Convertible Securities;

(iii) no readjustment pursuant to Article 7.3E(5)(c)(ii) shall have the effect of increasing the then effective Conversion Price to an amount which exceeds the Conversion Price for such series of Preferred Shares that would have been in effect had no adjustments in relation to the issuance of such Options or Convertible Securities as referenced in Article 7.3E(5)(c)(ii) been made;

- (iv) upon the expiration of any such Options or any rights of conversion or exchange under such Convertible Securities that have not been exercised, the then effective Conversion Price for such series of Preferred Share computed upon the original issue thereof (or upon the occurrence of a record date with respect thereto) and any subsequent adjustments based thereon shall, upon such expiration, be recomputed as if:
- (x) in the case of Convertible Securities or Options for Ordinary Shares, the only New Securities issued were the Ordinary Shares, if any, actually issued upon the exercise of such Options or the conversion or exchange of such Convertible Securities and the consideration received therefor was the consideration actually received by the Company for the issue of such exercised Options plus the consideration actually received by the Company upon such exercise or for the issue of all such Convertible Securities that were actually converted or exchanged, plus the additional consideration, if any, actually received by the Company upon such conversion or exchange, and
- (y) in the case of Options for Convertible Securities, only the Convertible Securities, if any, actually issued upon the exercise thereof were issued at the time of issue of such Options, and the consideration received by the Company for the New Securities deemed to have been then issued was the consideration actually received by the Company for the issue of such exercised Options, plus the consideration deemed to have been received by the Company (determined pursuant to Article 7.3E(5)(e)) upon the issue of the Convertible Securities with respect to which such Options were actually exercised; and
- (v) if such record date shall have been fixed and such Options or Convertible Securities are not issued on the date fixed therefor, the adjustment previously made in the Conversion Price for a particular series of Preferred Share which became effective on such record date shall be canceled as of the close of business on such record date, and thereafter such Conversion Price shall be adjusted pursuant to this Article 7.3E(5)(c) as of the actual date of their issuance.

(d) **Adjustment of Conversion Price upon Issuance of New Securities.** In the event of an issuance of New Securities, at any time after the Series B Issue Date, for a consideration per Ordinary Share received by the Company (net of any selling concessions, discounts or commissions) less than the Conversion Price for a particular series of Preferred Share in effect immediately prior to such issue, then and in such event, such Conversion Price shall be reduced, concurrently with such issue, to a price determined as set forth below:

$$\text{NCP} = \text{OCP} * (\text{OS} + (\text{NP}/\text{OCP})) / (\text{OS} + \text{NS})$$

WHERE:

NCP = the new Conversion Price for such series of Preferred Share,

OCP = the Conversion Price for such series of Preferred Share in effect immediately before the issuance of the New Securities,

OS = the total outstanding Ordinary Shares immediately before the issuance of the New Securities plus the total Ordinary Shares issuable upon conversion of the outstanding Convertible Securities and exercise of outstanding Options,

NP = the total consideration received for the issuance or sale of the New Securities, and

NS = the number of New Securities issued or sold or deemed issued or sold.

(e) **Determination of Consideration.** For purposes of this Article 7.3E(5), the consideration received by the Company for the issuance of any New Securities shall be computed as follows:

(i) **Cash and Property.** Such consideration shall:

(1) insofar as it consists of cash, be computed at the aggregate amount of cash received by the Company excluding amounts paid or payable for accrued interest or accrued dividends and excluding any discounts, commissions or placement fees payable by the Company to any underwriter or placement agent in connection with the issuance of any New Securities;

- (2) insofar as it consists of property other than cash, be computed at the fair market value thereof at the time of such issue, as determined and approved in good faith by the Board of Directors; provided, however, that no value shall be attributed to any services performed by any employee, officer or director of any Group Company;
- (3) in the event New Securities are issued together with other Shares or securities or other assets of the Company for consideration which covers both, be the proportion of such consideration so received which relates to such New Securities, computed as provided in clauses (1) and (2) above, as reasonably determined in good faith by the Board of Directors.

(ii) **Options and Convertible Securities**. The consideration per Ordinary Share received by the Company for New Securities deemed to have been issued pursuant to Article 7.3E(5)(c) hereof relating to Options and Convertible Securities, shall be determined by dividing (x) the total amount, if any, received or receivable by the Company as consideration for the issue of such Options or Convertible Securities (determined in the manner described in paragraph (i) above), plus the minimum aggregate amount of additional consideration (as set forth in the instruments relating thereto, without regard to any provision contained therein for a subsequent adjustment of such consideration) payable to the Company upon the exercise of such Options or the conversion or exchange of such Convertible Securities, or in the case of Options for Convertible Securities, the exercise of such Options for Convertible Securities and the conversion or exchange of such Convertible Securities by (y) the maximum number of Ordinary Shares (as set forth in the instruments relating thereto, without regard to any provision contained therein for a subsequent adjustment of such number) issuable upon the exercise of such Options or the conversion or exchange of such Convertible Securities.



(6) **No Impairment**. The Company will not, by amendment of these Articles or through any reorganization, recapitalization, transfer of assets, consolidation, merger, amalgamation, scheme of arrangement, dissolution, issue or sale of securities or any other voluntary action, avoid or seek to avoid the observance or performance of any of the terms to be observed or performed hereunder by the Company, but will at all times in good faith assist in the carrying out of all the provisions of this Article 7.3 and in the taking of all such action as may be necessary or appropriate to protect the conversion rights of the holders of Preferred Shares against impairment.

(7) **Certificate of Adjustment**. In the case of any adjustment or readjustment of the Conversion Price for any series of Preferred Shares, the Company, at its sole expense, shall compute such adjustment or readjustment in accordance with the provisions hereof and prepare a certificate showing such adjustment or readjustment, and shall deliver such certificate by notice to each registered holder of the Preferred Shares, at the holder's address as shown in the Company's books. The certificate shall set forth such adjustment or readjustment, showing in detail the facts upon which such adjustment or readjustment is based, including a statement of (i) the consideration received or deemed to be received by the Company for any New Securities issued or sold or deemed to have been issued or sold, (ii) the number of New Securities issued or sold or deemed to be issued or sold, (iii) the applicable Conversion Price in effect before and after such adjustment or readjustment, and (iv) the type and number of Equity Securities of the Company, and the type and amount, if any, of other property which would be received upon conversion of the Preferred Shares after such adjustment or readjustment.

(8) **Notice of Record Date**. In the event the Company shall propose to take any action of the type or types requiring an adjustment set forth in this Article 7.3E, the Company shall give notice to the holders of the relevant Preferred Shares, which notice shall specify the record date, if any, with respect to any such action and the date on which such action is to take place. Such notice shall also set forth such facts with respect thereto as shall be reasonably necessary to indicate the effect of such action (to the extent such effect may be known at the date of such notice) on the applicable Conversion Price and the number, kind or class of shares or other securities or property which shall be deliverable upon the occurrence of such action or deliverable upon the conversion of the relevant Preferred Shares. In the case of any action which would require the fixing of a record date, such notice shall be given at least twenty (20) days prior to the date so fixed, and in the case of all other actions, such notice shall be given at least thirty (30) days prior to the taking of such proposed action.

(9) **Reservation of Shares Issuable Upon Conversion.** The Company shall at all times reserve and keep available out of its authorized but unissued Ordinary Shares, solely for the purpose of effecting the conversion of the Preferred Shares, such number of its Ordinary Shares as shall from time to time be sufficient to effect the conversion of all issued and outstanding Preferred Shares. If at any time the number of authorized but unissued Ordinary Shares shall not be sufficient to effect the conversion of all then issued and outstanding Preferred Shares, in addition to such other remedies as shall be available to the holders of Preferred Shares, the Company and its Members will take such corporate action as may, in the opinion of its counsel, be necessary to increase its authorized but unissued Ordinary Shares to such number of shares as shall be sufficient for such purpose.

(10) **Notices.** Any notice required or permitted pursuant to this Article 7.3 shall be given in writing and shall be given in accordance with Articles 104 through 108.

(11) **Payment of Taxes.** The Company will pay all taxes (other than taxes based upon income) and other governmental charges that may be imposed with respect to the issue or delivery of Ordinary Shares upon conversion of the Preferred Shares, excluding any tax or other charge imposed in connection with any transfer involved in the issue and delivery of Ordinary Shares in a name other than that in which such Preferred Shares so converted were registered.

#### 7.4 **Voting Rights.**

- A. **General Rights.** Subject to the provisions of the Memorandum and these Articles (including any Article providing for special voting rights), at all general meetings of the Company: (a) the holder of each Ordinary Share issued and outstanding shall have one vote in respect of each Ordinary Share held, and (b) the holder of a Preferred Share shall be entitled to such number of votes as equals the whole number of Ordinary Shares into which such holder's collective Preferred Shares are convertible immediately after the close of business on the record date of the determination of the Company's Members entitled to vote or, if no such record date is established, at the date such vote is taken or any written consent of the Company's Members is first solicited. Fractional votes shall not, however, be permitted and any fractional voting rights available on an as converted basis (after aggregating all shares into which the Preferred Shares held by each holder could be converted) shall be rounded to the nearest whole number (with one-half being rounded upward). To the extent that the Statute or the Articles allow the Preferred Shares to vote separately as a class or series with respect to any matters, the Preferred Shares, shall have the right to vote separately as a class or series with respect to such matters.

B. **Protective Provisions.**

1. **Approval by Majority Preferred Shareholders.** So long as no less than fifty percent (50%) of the Preferred Shares issued at the Closing are issued and outstanding, the Company shall not take, permit to occur, approve, authorize, or agree or commit to do any of the following, and each Member shall procure the Company not to, take, permit to occur, approve, authorize, or agree or commit to do any of the following, and the Company shall procure any other Group Company not to take, permit to occur, approve, authorize, or agree or commit to do any of the following, whether in a single transaction or a series of related transactions, whether directly or indirectly, and whether or not by amendment, merger, consolidation, scheme of arrangement, amalgamation, or otherwise, without the written consent or affirmative vote of the Majority Preferred Holders given in writing or by vote at a meeting, consenting or voting (as the case may be) (vote together and separately as a class or series), provided that where any such action requires the approval of a Special Resolution under the Statute and if the consent or affirmative vote by the Majority Preferred Holders has not been obtained, the Majority Preferred Holders voting against such resolution shall have the voting rights equal to the aggregate power of all shareholders who vote in favour of such resolution plus one.

- (1) any adverse amendment or change of the rights, preferences, privileges or powers of, or the restrictions provided for the benefit of, the Preferred Shares;
- (2) creation, authorization or issuance of any class or series of Equity Securities having rights, preferences, privileges or powers superior to or on a parity with the Preferred Shares, whether as to liquidation, conversion, dividend, voting, redemption, or otherwise, or any Equity Securities convertible into, exchangeable for, or exercisable into any Equity Securities having rights, preferences, privileges or powers superior to or on a parity with any series of Preferred Shares, whether as to liquidation, conversion, dividend, voting, redemption or otherwise;
- (3) any action that reclassifies any outstanding shares into shares having rights, preferences, privileges or powers senior to or on a parity with the Preferred Shares, whether as to liquidation, conversion, dividend, voting, redemption or otherwise;
- (4) any amendment or modification to the Charter Documents, other than amendments pursuant to and in compliance with Section 15.17 of the Shareholders Agreement and other than to effect a Qualified IPO;
- (5) any declaration, set aside or payment of a dividend or other distribution by the Company;

- (6) any change of the size or composition of the board of directors of any Group Company other than changes pursuant to and in compliance with the Shareholders Agreement;
- (7) any increase or decrease in the authorized number of Preferred Shares, or any series thereof;
- (8) any Deemed Liquidation Event or any Share Sale or any merger, amalgamation, scheme or arrangement or consolidation of any Group Company with any Person, or the purchase or other acquisition by any Group Company of all or substantially all of the assets, equity or business of another Person, other than in any case an Approved Sale; or
- (9) any action by a Group Company to authorize, approve or enter into any agreement or obligation with respect to any of the above actions.

**REGISTER OF MEMBERS**

- 8. The Company shall maintain or cause to be maintained the Register of Members in accordance with the Statute. The Register of Members shall be the only evidence as to who are the Members entitled to examine the Register of Members or to vote in person or by proxy at any meeting of Members.

**FIXING RECORD DATE**

- 9. The Directors may fix in advance a date as the record date for any determination of Members entitled to notice of or to vote at a meeting of the Members, or any adjournment thereof, and for the purpose of determining the Members entitled to receive payment of any dividend the Directors may, at or within ninety (90) days prior to the date of declaration of such dividend, fix a subsequent date as the record date for such determination.
- 10. If no record date is fixed for the determination of Members entitled to notice of, or to vote at, a meeting of Members or Members entitled to receive payment of a dividend, the date on which notice of the meeting is sent or the date on which the resolution of the Directors declaring such dividend is adopted, as the case may be, shall be the record date for such determination of Members. When a determination of Members entitled to vote at any meeting of Members has been made as provided in this Article, such determination shall apply to any adjournment thereof.

**CERTIFICATES FOR SHARES**

- 11. A Member shall only be entitled to a share certificate if the Directors resolve that share certificates shall be issued. Share certificates representing Shares, if any, shall be in such form as the Directors may determine. Share certificates shall be signed by one or more Directors or other Person authorised by the Directors. The Directors may authorise certificates to be issued with the authorised signature(s) affixed by mechanical process. All certificates for Shares shall be consecutively numbered or otherwise identified and shall specify the Shares to which they relate. All certificates surrendered to the Company for transfer shall be cancelled and, subject to these Articles, no new certificate shall be issued until the former certificate representing a like number of relevant Shares shall have been surrendered and cancelled.

12. The Company shall not be bound to issue more than one certificate for Shares held jointly by more than one Person and delivery of a certificate to one joint holder shall be a sufficient delivery to all of them.
13. If a share certificate is defaced, worn out, lost or destroyed, it may be renewed on such terms (if any) as to evidence and indemnity and on the payment of such expenses reasonably incurred by the Company in investigating evidence, as the Directors may prescribe, and (in the case of defacement or wearing out) upon delivery of the old certificate.

#### **TRANSFER OF SHARES**

14. The Shares of the Company are subject to transfer restrictions as set forth in Schedule A attached hereto. The Company will register transfers of Shares that are made in accordance with Schedule A and will not register transfers of Shares that are made in violation of Schedule A. The instrument of transfer of any Share shall be in writing and shall be executed by or on behalf of the transferor (and, if the Directors so require, signed by the transferee). The transferor shall be deemed to remain the holder of a Share until the name of the transferee is entered in the Register of Members.

#### **REDEMPTION AND REPURCHASE OF SHARES**

15. The Company is permitted to redeem, purchase or otherwise acquire any of the Company's Shares, so long as such redemption, purchase or acquisition (i) is pursuant to any redemption provisions set forth in these Articles, (ii) is as otherwise agreed by the holder of such Share and the Company, subject in the case of clause (ii) to compliance with any applicable restrictions set forth in the Shareholders Agreement, the Memorandum and these Articles.
16. Subject to the provisions of the Statute and these Articles, the Company may issue Shares that are to be redeemed or are liable to be redeemed at the option of the Member or the Company. Subject to the provisions of the Statute and these Articles, the Directors may authorize the redemption or purchase by the Company of its own Shares in such manner and on such terms as they think fit and may make a payment in respect of the redemption or purchase of its own Shares in any manner permitted by the Statute, including out of capital.

**VARIATION OF RIGHTS OF SHARES**

17. Subject to Article 7, if at any time the share capital of the Company is divided into different classes of Shares, the rights attached to any class (unless otherwise provided by the terms of issue of the Shares of that class) may only be varied with the consent in writing of Members holding not less than a majority of the votes entitled to be cast by holders (in person or by proxy) of Shares on a poll at a general meeting of such class affected by the proposed variation of rights or with the sanction of a resolution of such Members holding not less than a majority of the votes which could be cast by holders (in person or by proxy) of Shares of such class on a poll at a general meeting but not otherwise:
18. For the purpose of the preceding Article, all of the provisions of these Articles relating to general meetings shall apply, to the extent applicable, mutatis mutandis, to every such separate meeting except that the necessary quorum shall be one or more Persons holding or representing by proxy at least a majority of the issued Shares of such class and that any Member holding Shares of such class, present in person or by proxy, may demand a poll.
19. Subject to Article 7, the rights conferred upon the holders of Shares or any class of Shares shall not, unless otherwise expressly provided by the terms of issue of such Shares, be deemed to be varied by the creation, re-designation, or issue of Shares ranking pari passu therewith.

**COMMISSION ON SALE OF SHARES**

20. The Company may, with the approval of the Board, so far as the Statute permits, pay a commission to any Person in consideration of his or her subscribing or agreeing to subscribe whether absolutely or conditionally for any Shares of the Company. Such commissions may be satisfied by the payment of cash and/or the issue of fully or partly paid-up Shares. The Company may also on any issue of Shares pay such brokerage as may be lawful.

**NON RECOGNITION OF INTERESTS**

21. The Company shall not be bound by or compelled to recognise in any way (even when having notice thereof) any equitable, contingent, future or partial interest in any Share, or (except only as is otherwise provided by these Articles or the Statute) any other rights in respect of any Share other than an absolute right to the entirety thereof in the registered holder.

**TRANSMISSION OF SHARES**

22. If a Member dies, the survivor or survivors where such Member was a joint holder, and his or her legal personal representatives where such Member was a sole holder, shall be the only Persons recognised by the Company as having any title to such Member's interest. The estate of a deceased Member is not thereby released from any liability in respect of any Share that had been jointly held by such Member.

23. Any Person becoming entitled to a Share in consequence of the death or bankruptcy or liquidation or dissolution of a Member (or in any other way than by transfer) may, upon such evidence being produced as may from time to time be required by the Directors, elect either to become the holder of the Share or to have some Person nominated by him or her as the transferee, but the Directors shall, in any case, have the same right to decline or suspend registration as they would have had in the case of a transfer by that Member before his death or bankruptcy pursuant to Article 14. If he or she elects to become the holder, he or she shall give written notice to the Company to that effect.
24. If the Person so becoming entitled shall elect to be registered as the holder, such Person shall deliver or send to the Company a notice in writing signed by such Person stating that he or she so elects.

**AMENDMENTS OF MEMORANDUM AND ARTICLES OF ASSOCIATION AND ALTERATION OF CAPITAL**

25. Subject to Article 7, the Company may by Ordinary Resolution:
- A. increase the share capital by such sum as the resolution shall prescribe and with such rights, priorities and privileges annexed thereto, as the Company in general meeting may determine;
  - B. consolidate and divide all or any of its share capital into Shares of larger amount than its existing Shares;
  - C. by subdivision of its existing Shares or any of them divide the whole or any part of its share capital into Shares of smaller amount than is fixed by the Memorandum or into Shares without par value;
  - D. cancel any Shares that at the date of the passing of the resolution have not been taken or agreed to be taken by any Person; and
  - E. perform any action not required to be performed by Special Resolution.
26. Subject to the provisions of the Statute and the provisions of these Articles as regards the matters to be dealt with by Ordinary Resolution, and subject further to Article 7, the Company may by Special Resolution:
- A. change its name;
  - B. alter or add to these Articles;
  - C. alter or add to the Memorandum with respect to any objects, powers or other matters specified therein; and
  - D. reduce its share capital and any capital redemption reserve fund.

**REGISTERED OFFICE**

27. Subject to the provisions of the Statute, the Company may by resolution of the Directors change the location of its Registered Office.

**GENERAL MEETINGS**

28. All general meetings other than annual general meetings shall be called extraordinary general meetings.
29. The Company shall, if required by the Statute, in each year hold a general meeting as its annual general meeting, and shall specify the meeting as such in the notices calling it. The annual general meeting shall be held at such time and place as the Directors shall appoint. At these meetings, the report of the Directors (if any) shall be presented.
30. The Directors may call general meetings, and they shall on a Members requisition forthwith proceed to convene an extraordinary general meeting of the Company.
31. A Members requisition is a requisition of Members of the Company holding, on the date of deposit of the requisition, not less than twenty percent (20%) of the paid up capital of the Company as at the date of the deposit carries the right of voting at general meetings of the Company,
32. The requisition must state the objects of the meeting and must be signed by the requisitionists and deposited at the Registered Office, and may consist of several documents in like form each signed by one or more requisitionists.
33. If the Directors do not within twenty-one (21) days from the date of the deposit of the requisition duly proceed to convene a general meeting to be held within a further twenty-one (21) days, the requisitionists, or any of them representing more than one-half of the total voting rights of all of them, may themselves convene a general meeting, but any meeting so convened shall not be held after the expiration of three (3) months after the expiration of the said twenty-one (21) days.
34. A general meeting convened as aforesaid by requisitionists shall be convened in the same manner as nearly as possible as that in which general meetings are to be convened by Directors.

**NOTICE OF GENERAL MEETINGS**

35. At least ten (10) days' notice shall be given of any general meeting unless such notice is waived either before, at or after such meeting both (i) by the Members (or their proxies) holding a majority of the aggregate voting power of all of the Ordinary Shares entitled to attend and vote thereat (including the Preferred Shares on an as converted basis), and (ii) by the Majority Preferred Holders (or their proxies). Every notice shall be exclusive of the day on which it is given or deemed to be given and shall specify the place, the day and the hour of the meeting and the general nature of the business and shall be given in the manner hereinafter mentioned or in such other manner, if any, as may be prescribed by the Company, provided that a general meeting of the Company shall, whether or not the notice specified in this regulation has been given and whether or not the provisions of the Articles regarding general meetings have been complied with, be deemed to have been duly convened if it is so agreed both (i) by the Members (or their proxies) holding a majority of the aggregate voting power of all of the Ordinary Shares entitled to attend and vote thereat (including the Preferred Shares on an as converted basis), and (ii) by the Majority Preferred Holders (or their proxies).



36. The officer of the Company who has charge of the Register of Members of the Company shall prepare and make, at least two (2) days before every general meeting, a complete list of the Members entitled to vote at the general meeting, and showing the address of each Member and the number of shares registered in the name of each Member. Such list shall be open to examination by any Member for any purpose germane to the meeting, during ordinary business hours, for a period of at least two (2) days prior to the meeting, either at a place within the city where the meeting is to be held, which place shall be specified in the notice of the meeting, or, if not so specified, at the place where the meeting is to be held. The list shall also be produced and kept at the time and place of the meeting during the whole time thereof, and may be inspected by any Member of the Company who is present.

**PROCEEDINGS AT GENERAL MEETINGS**

37. The holders of a majority of the aggregate voting power of all of the Ordinary Shares entitled to notice of and to attend and vote at such general meeting (including the Preferred Shares on an as converted basis) together present in person or by proxy or if a company or other non-natural Person by its duly authorised representative shall be a quorum. Subject to Article 39, no business shall be transacted at any general meeting unless a quorum is present at the time when the meeting proceeds to business. A Person may participate at a general meeting by conference telephone or other communications equipment by means of which all the Persons participating in the meeting can communicate with each other. Participation by a Person in a general meeting in this manner is treated as presence in person at that meeting.
38. A resolution in writing (in one or more counterparts) shall be as valid and effective as if the resolution had been passed at a duly convened and held general meeting of the Company if:
- A. in the case of a Special Resolution, it is signed by all Members (or their duly authorized representative or proxy) required for such Special Resolution to be deemed effective under the Statute; or
  - B. in the case of any resolution passed other than as a Special Resolution, it is signed by Members (or their duly authorized representative or proxy) for the time being holding Shares carrying in aggregate not less than the minimum number of votes that would be necessary to authorize or take such action at a general meeting at which all Shares entitled to vote thereon were present and voted (calculated in accordance with Article 7.4A) (or, being companies, signed by their duly authorised representative).

39. A quorum, once established, shall not be broken by the withdrawal of enough votes to leave less than a quorum and the votes present may continue to transact business until adjournment. If, however, such quorum shall not be present or represented at any general meeting, the Members (or their proxies) holding a majority of the aggregate voting power of all of the Shares of the Company represented at the meeting may adjourn the meeting from time to time, until a quorum shall be present or represented.
40. The chairman, if any, of the Board of Directors shall preside as chairman at every general meeting of the Company, or if there is no such chairman, or if he or she shall not be present within ten (10) minutes after the time appointed for the holding of the meeting, or is unwilling or unable to act, the Directors present shall elect one of their number, or shall designate a Member, to be chairman of the meeting; provided that, if notice of such meeting has been duly delivered to all Members in accordance with the notice procedures hereunder, and the quorum is not present within one hour from the time appointed for the meeting solely because of the absence of any holder of Preferred Shares, the meeting shall be adjourned to the seventh (7th) following Business Day at the same time and place (or to such other time or such other place as the directors may determine) with notice delivered to all Members five (5) days prior to the adjourned meeting in accordance with the notice procedures under Articles 104 through 108 and if at the adjourned meeting the quorum is not present within one half hour from the time appointed for the meeting solely because of the absence of the Majority Preferred Holders, then the separate requirement that the Majority Preferred Holders be present for a quorum to be established shall not apply to such adjourned meeting for purposes of establishing a quorum. At such adjourned meeting, any business may be transacted that might have been transacted at the meeting as originally notified.
41. With the consent of a general meeting at which a quorum is present, the chairman may (and shall if so directed by the meeting), adjourn the meeting from time to time and from place to place, but no business shall be transacted at any adjourned meeting other than the business left unfinished at the meeting from which the adjournment took place. When a general meeting is adjourned, notice of the adjourned meeting shall be given as in the case of an original meeting.
42. A resolution put to the vote of the meeting shall be decided by poll and not on a show of hands.
43. On a poll a Member shall have one vote for each Ordinary Share he holds on an as converted basis, unless any Share carries special voting rights.
44. Except on a poll on a question of adjournment, a poll shall be taken as the chairman directs, and the result of the poll shall be deemed to be the resolution of the general meeting at which the poll was demanded.
45. A poll on a question of adjournment shall be taken forthwith.
46. A poll on any other question shall be taken at such time as the chairman of the general meeting directs, and any business other than that upon which a poll has been demanded or is contingent thereon may proceed pending the taking of the poll.

**VOTES OF MEMBERS**

47. Except as otherwise required by law or these Articles, the Ordinary Shares and the Preferred Shares shall vote together on an as converted basis on all matters submitted to a vote of Members.
48. In the case of joint holders of record, the vote of the senior holder who tenders a vote, whether in person or by proxy, shall be accepted to the exclusion of the votes of the other joint holders, and seniority shall be determined by the order in which the names of the holders stand in the Register of Members.
49. A Member of unsound mind, or in respect of whom an order has been made by any court, having jurisdiction in lunacy, may vote by his or her committee, receiver, or other Person on such Member's behalf appointed by that court, and any such committee, receiver, or other Person may vote by proxy.
50. No Person shall be entitled to vote at any general meeting or at any separate meeting of the holders of a class or series of Shares unless he or she is registered as a Member on the record date for such meeting nor unless all calls or other monies then payable by such Member in respect of Shares have been paid.
51. No objection shall be raised to the qualification of any voter except at the general meeting or adjourned general meeting at which the vote objected to is given or tendered and every vote not disallowed at the meeting shall be valid. Any objection made in due time shall be referred to the chairman whose decision shall be final and conclusive.
52. Votes may be cast either personally or by proxy. A Member may appoint more than one proxy or the same proxy under one or more instruments to attend and vote at a meeting.
53. A Member holding more than one Share need not cast the votes in respect of his or her Shares in the same way on any resolution and therefore may vote a Share or some or all such Shares either for or against a resolution and/or abstain from voting a Share or some or all of the Shares and, subject to the terms of the instrument appointing him or her, a proxy appointed under one or more instruments may vote a Share or some or all of the Shares in respect of which he or she is appointed either for or against a resolution and/or abstain from voting.

**PROXIES**

54. The instrument appointing a proxy shall be in writing, be executed under the hand of the appointor or of his or her attorney duly authorised in writing, or, if the appointor is a corporation, under the hand of an officer or attorney duly authorised for that purpose. A proxy need not be a Member of the Company.

55. The instrument appointing a proxy shall be deposited at the Registered Office or at such other place as is specified for that purpose in the notice convening the meeting, no later than the time for holding the meeting or adjourned meeting.
56. The instrument appointing a proxy may be in any usual or common form and may be expressed to be for a particular meeting or any adjournment thereof or generally until revoked. An instrument appointing a proxy shall be deemed to include the power to demand or join or concur in demanding a poll.
57. Votes given in accordance with the terms of an instrument of proxy shall be valid notwithstanding the previous death or insanity of the principal or revocation of the proxy or of the authority under which the proxy was executed, or the transfer of the Share in respect of which the proxy is given unless notice in writing of such death, insanity, revocation or transfer was received by the Company at the Registered Office before the commencement of the general meeting or adjourned meeting at which it is sought to use the proxy.

#### **CORPORATE MEMBERS**

58. Any corporation or other non-natural Person that is a Member may in accordance with its constitutional documents, or in the absence of such provision by resolution of its directors or other governing body, authorise such Person as it thinks fit to act as its representative at any meeting of the Company or any class of Members, and the Person so authorised shall be entitled to exercise the same powers on behalf of the corporation which he or she represents as the corporation could exercise if it were an individual Member.

#### **SHARES THAT MAY NOT BE VOTED**

59. Shares in the Company that are beneficially owned by the Company or held by it in a fiduciary capacity shall not be voted, directly or indirectly, at any meeting and shall not be counted in determining the total number of issued and outstanding Shares at any given time.

#### **APPOINTMENT OF DIRECTORS**

60. The authorized number of directors on the Board shall be four (4) directors, with the composition of the Board determined as follows: the holders of a majority of the voting power of the issued and outstanding Ordinary Shares (voting as a separate class) shall be exclusively entitled to designate, appoint, remove, replace and reappoint at any time or from time to time four (4) directors on the Board.

#### **POWERS OF DIRECTORS**

61. Subject to the provisions of the Statute, the Memorandum and these Articles and to any directions given by Special Resolution, the business of the Company shall be managed by or under the direction of the Directors who may exercise all the powers of the Company; provided, however, that the Company shall not carry out any action inconsistent with Article 7. No alteration of the Memorandum or these Articles and no such direction shall invalidate any prior act of the Directors that would have been valid if that alteration had not been made or that direction had not been given. A duly convened meeting of Directors at which a quorum is present may exercise all powers exercisable by the Directors.

62. All cheques, promissory notes, drafts, bills of exchange and other negotiable instruments and all receipts for monies paid to the Company shall be signed, drawn, accepted, endorsed or otherwise executed as the case may be in such manner as the Directors shall determine.
63. Subject to Article 7, the Directors on behalf of the Company may pay a gratuity or pension or allowance on retirement to any Director who has held any other salaried office or place of profit with the Company or to his or her spouse or dependants and may make contributions to any fund and pay premiums for the purchase or provision of any such gratuity, pension or allowance.
64. Subject to Article 7, the Directors may exercise all the powers of the Company to borrow money and to mortgage or charge its undertaking, property and uncalled capital or any part thereof and to issue debentures, debenture shares, mortgages, bonds and other such securities whether outright or as security for any debt, liability or obligation of the Company or of any third party.

**VACATION OF OFFICE AND REMOVAL OF DIRECTOR**

65. The office of a Director shall be vacated if:
- A. such Director gives notice in writing to the Company that he or she resigns the office of Director; or
  - B. such Director dies, becomes bankrupt or makes any arrangement or composition with such Director's creditors generally; or
  - C. such Director is found to be or becomes of unsound mind.
66. Any Director who shall have been elected by a specified group of Members may be removed during the aforesaid term of office, either for or without cause, by, and only by, the affirmative vote of the group of Members then entitled to elect such Director in accordance with Article 60, given at a special meeting of such Members duly called or by an action by written consent for that purpose. Any vacancy in the Board of Directors caused as a result of such removal or one or more of the events set out in Article 65 of any Director who shall have been elected by a specified group of Members, may be filled by, and only by, the affirmative vote of the group of Members then entitled to elect such Director in accordance with Article 60, given at a special meeting of such Members duly called or by an action by written consent for that purpose, unless otherwise agreed upon among such Members; provided further that the said approval process by the majority of the Board shall in no event unfairly deprive a specified group's right to appoint a replacement director in accordance with Article 60.

## **PROCEEDINGS OF DIRECTORS**

67. A Director may by a written instrument appoint an alternate who need not be a Director, and an alternate is entitled to attend meetings in the absence of the Director who appointed him and to vote or consent in place of the Director. At all meetings of the Board of Directors a majority of the number of the Directors in office elected in accordance with Article 60 shall be necessary and sufficient to constitute a quorum for the transaction of business, and the vote of a majority of the Directors present (in person or in alternate) at any meeting at which there is a quorum, shall be the act of the Board of Directors, except as may be otherwise specifically provided by the Statute, the Memorandum or these Articles. If only one Director is elected, such sole Director shall constitute a quorum. If within half an hour from the time appointed for the meeting a quorum is not present, the meeting shall be adjourned to the same day in the next week at the same time and place or to such other time or such other place as the Directors may determine.
68. Subject to the provisions of these Articles, the Directors may regulate their proceedings as they think fit, provided however that the board meetings shall be held at least once every three (3) months unless the Board otherwise approves and that the written notice of each meeting given to the Directors shall include an agenda of the business to be transacted at the meeting.
69. A Person may participate in a meeting of the Directors or committee of the Board of Directors by conference telephone or other communications equipment by means of which all the Persons participating in the meeting can communicate with each other at the same time. Participation by a Person in a meeting in this manner is treated as presence in person at that meeting. Unless otherwise determined by the Directors, the meeting shall be deemed to be held at the place where the chairman is at the start of the meeting.
70. A resolution in writing (in one or more counterparts) signed by majority of the Directors or majority of the members of a committee of the Board of Directors shall be as valid and effectual as if it had been passed at a meeting of the Directors, or committee of the Board of Directors as the case may be, duly convened and held.
71. Meetings of the Board of Directors may be called by any Director on forty-eight (48) hours' notice to each Director in accordance with Articles 104 through 108.
72. The continuing Directors may act notwithstanding any vacancy in their body, but if and so long as their number is reduced below the number fixed by or pursuant to these Articles as the necessary quorum of Directors, the continuing Directors or Director may act for the purpose of increasing the number of Directors to that number, or of summoning a general meeting of the Company, but for no other purpose.
73. The Directors may elect a chairman of their board and determine the period for which he or she is to hold office; but if no such chairman is elected, or if at any meeting the chairman shall not be present within ten (10) minutes after the time appointed for holding the same, the Directors present may choose one of their members to be chairman of the meeting.

74. All acts done by any meeting of the Directors or of a committee of the Board of Directors shall, notwithstanding that it be afterwards discovered that there was some defect in the appointment of any Director or that they or any of them were disqualified, be as valid as if every such Person had been duly appointed and qualified to be a Director.

**PRESUMPTION OF ASSENT**

75. A Director of the Company who is present at a meeting of the Directors at which action on any Company matter is taken shall be presumed to have assented to the action taken unless the Director's dissent shall be entered in the minutes of the meeting or unless the Director shall file his or her written dissent from such action with the Person acting as the chairman or secretary of the meeting before the adjournment thereof or shall forward such dissent by registered post to such Person immediately after the adjournment of the meeting. Such right to dissent shall not apply to a Director who voted in favour of such action.

**DIRECTORS' INTERESTS**

76. Subject to Article 79, a Director may hold any other office or place of profit under the Company (other than the office of Auditor) in conjunction with his or her office of Director for such period and on such terms as to remuneration and otherwise as the Directors may determine.
77. Subject to Article 79, a Director may act by himself or herself or his or her firm in a professional capacity for the Company and such Director or firm shall be entitled to remuneration for professional services as if such Director were not a Director.
78. Subject to Article 79, a Director of the Company may be or become a director or other officer of or otherwise interested in any company promoted by the Company or in which the Company may be interested as Member or otherwise, and no such Director shall be accountable to the Company for any remuneration or other benefits received by such Director as a director or officer of, or from his or her interest in, such other company.
79. In addition to any further restrictions set forth in these Articles, no Person shall be disqualified from the office of Director or prevented by such office from contracting with the Company, either as vendor, purchaser or otherwise, nor shall any such contract or any contract or transaction entered into by or on behalf of the Company in which any Director shall be in any way interested (each, an "**Interested Transaction**") be or be liable to be avoided, nor shall any Director so contracting or being so interested be liable to account to the Company for any profit realised by any such Interested Transaction by reason of such Director holding office or of the fiduciary relation thereby established, and any such director may vote at a meeting of directors on any resolution concerning a matter in which that director has an interest (and if he votes his vote shall be counted) and shall be counted towards a quorum of those present at such meeting, in each case so long as the material facts of the interest of each Director in the agreement or transaction and his interest in or relationship to any other party to the agreement or transaction are disclosed in good faith to and are known by the other Directors. A general notice or disclosure to the Directors or otherwise contained in the minutes of a meeting or a written resolution of the directors or any committee thereof that a Director is a member of any specified firm or company and is to be regarded as interested in any transaction with such firm or company shall be sufficient disclosure under this Article 79.

**MINUTES**

80. The Directors shall cause minutes to be made in books kept for the purpose of all appointments of officers made by the Directors, all proceedings at meetings of the Company or the holders of any series of Shares and of the Directors, and of committees of the Board of Directors including the names of the Directors present at each meeting.

**DELEGATION OF DIRECTORS' POWERS**

81. Subject to these Articles, the Board of Directors may establish any committees and approve the delegation of any of their powers to any committee consisting of one or more Directors. The Board of Directors may designate one or more Directors as alternate members of any committee, who may replace any absent or disqualified member at any meeting of any such committee.
82. The Board of Directors may also, delegate to any managing Director or any Director holding any other executive office such of their powers as they consider desirable to be exercised by such Person provided that the appointment of a managing Director shall be revoked forthwith if he or she ceases to be a Director. Any such delegation may be made subject to any conditions the Board of Directors may impose, and either collaterally with or to the exclusion of their own powers and may be revoked or altered.
83. Subject to these Articles, the Directors may by power of attorney or otherwise appoint any company, firm, Person or body of Persons, whether nominated directly or indirectly by the Directors, to be the attorney or authorised signatory of the Company for such purpose and with such powers, authorities and discretions (not exceeding those vested in or exercisable by the Directors under these Articles) and for such period and subject to such conditions as they may think fit, and any such powers of attorney or other appointment may contain such provisions for the protection and convenience of Persons dealing with any such attorneys or authorised signatories as the Directors may think fit and may also authorise any such attorney or authorised signatory to delegate all or any of the powers, authorities and discretions vested in him or her.
84. Subject to these Articles, the Directors may appoint such officers as they consider necessary on such terms, at such remuneration and to perform such duties, and subject to such provisions as to disqualification and removal as the Directors may think fit. Unless otherwise specified in the terms of an officer's appointment, an officer may be removed by resolution of the Directors or Members.



**NO MINIMUM SHAREHOLDING**

85. There is no minimum shareholding required to be held by a Director.

**REMUNERATION OF DIRECTORS**

86. The remuneration to be paid to the Directors, if any, shall be such remuneration as determined by the Board. The Directors shall also be entitled to be paid all reasonable travelling, hotel and other out-of-pocket expenses properly incurred by them in connection with their attendance at meetings of the Board of Directors or committees of the Board of Directors, or general meetings of the Company, or separate meetings of the holders of any series of Shares or debentures of the Company, or otherwise in connection with the business of the Company.
87. The Directors may by resolution of the majority of the Board approve additional remuneration to any Director for any services other than his or her ordinary routine work as a Director. Any fees paid to a Director who is also counsel or solicitor to the Company, or otherwise serves it in a professional capacity, shall be in addition to his or her remuneration as a Director.

**SEAL**

88. The Company may, if the Directors so determine, have a Seal. The Seal shall only be used by the authority of the Directors or of a committee of the Board of Directors authorised by the Board of Directors. Every instrument to which the Seal has been affixed shall be signed by at least one Person who shall be either a Director or some officer or other Person appointed by the Directors for the purpose.
89. The Company may have for use in any place or places outside the Cayman Islands a duplicate Seal or Seals each of which shall be a facsimile of the common Seal of the Company and, if the Directors so determine, with the addition on its face of the name of every place where it is to be used.
90. A Director or officer, representative or attorney of the Company may without further authority of the Directors affix the Seal over his or her signature alone to any document of the Company required to be authenticated by him or her under seal or to be filed with the Registrar of Companies in the Cayman Islands or elsewhere wheresoever.

**DIVIDENDS, DISTRIBUTIONS AND RESERVE**

91. Subject to the Statute and these Articles (including Article 7), the Directors may declare dividends and distributions on Shares in issue and authorise payment of the dividends or distributions out of the assets of the Company lawfully available therefor. No dividend or distribution shall be paid except out of the realised or unrealised profits of the Company, or out of the share premium account or as otherwise permitted by the Statute.

92. All dividends and distributions shall be declared and paid according to the provisions of Article 7.
93. The Directors may deduct from any dividend or distribution payable to any Member all sums of money (if any) then payable by such Member to the Company on account of calls or otherwise.
94. Subject to the provisions of Article 7, the Directors may declare that any dividend or distribution be paid wholly or partly by the distribution of specific assets and in particular of shares, debentures or securities of any other company or in any one or more of such ways and where any difficulty arises in regard to such distribution, the Directors may settle the same as they think expedient and in particular may issue fractional Shares and fix the value for distribution of such specific assets or any part thereof and may determine that cash payments shall be made to any Members upon the basis of the value so fixed in order to adjust the rights of all Members and may vest any such specific assets in trustees as may seem expedient to the Directors.
95. Any dividend, distribution, interest or other monies payable in cash in respect of Shares may be paid by wire transfer to the holder or by cheque or warrant sent through the post directed to the registered address of the holder or, in the case of joint holders, to the registered address of the holder who is first named on the Register of Members or to such Person and to such address as such holder or joint holders may in writing direct. Every such cheque or warrant shall be made payable to the order of the Person to whom it is sent. Any one of two or more joint holders may give effectual receipts for any dividends, bonuses or other monies payable in respect of the Share held by them as joint holders.
96. No dividend or distribution shall bear interest against the Company, except as expressly provided in these Articles.
97. Any dividend that cannot be paid to a Member and/or that remains unclaimed after six (6) months from the date of declaration of such dividend may, in the discretion of the Directors, be paid into a separate account in the Company's name, provided that the Company shall not be constituted as a trustee in respect of that account and the dividend shall remain as a debt due to the Member. Any dividend that remains unclaimed after a period of six (6) years from the date of declaration of such dividend shall be forfeited and shall revert to the Company.

#### CAPITALIZATION

98. Subject to these Articles, including but not limited to Article 7, the Directors may capitalise any sum standing to the credit of any of the Company's reserve accounts (including share premium account and capital redemption reserve fund) or any sum standing to the credit of profit and loss account or otherwise available for distribution and to appropriate such sum to Members in the proportions in which such sum would have been divisible amongst them had the same been a distribution of profits by way of dividend as set forth in Article 7 hereof and to apply such sum on their behalf in paying up in full unissued Shares for allotment and distribution credited as fully paid-up to and amongst them in the proportion aforesaid. In such event, the Directors shall do all acts and things required to give effect to such capitalization, with full power to the Directors to make such provisions as they think fit for the case of Shares becoming distributable in fractions (including provisions whereby the benefit of fractional entitlements accrue to the Company rather than to the Members concerned). The Directors may authorise any Person to enter on behalf of all of the Members interested into an agreement with the Company providing for such capitalization and matters incidental thereto and any agreement made under such authority shall be effective and binding on all concerned.

### **BOOKS OF ACCOUNT**

99. The Directors shall cause proper books of account to be kept at such place as they may from time to time designate with respect to all sums of money received and expended by the Company and the matters in respect of which the receipt or expenditure takes place, all sales and purchases of goods by the Company and the assets and liabilities of the Company. Proper books shall not be deemed to be kept if there are not kept such books of account as are necessary to give a true and fair view of the state of the Company's affairs and to explain its transactions. The Directors shall from time to time determine whether and to what extent and at what times and places, and under what conditions or regulations, the accounts and books of the Company or any of them shall be open to inspection of Members not being Directors and no such Member shall have any right of inspecting any account or book or document of the Company except as conferred by the Statute or authorized by the Directors or the Company in general meeting or in a written agreement binding on the Company.
100. The Directors may from time to time cause to be prepared and to be laid before the Company in general meeting profit and loss accounts, balance sheets, group accounts (if any) and such other reports and accounts as may be required by law.

### **AUDIT**

101. The Directors may appoint an Auditor of the Company who shall hold office until removed from office by a resolution of the Directors, and may fix the Auditor's remuneration.
102. Every Auditor of the Company shall have a right of access at all times to the books and accounts and vouchers of the Company and shall be entitled to require from the Directors and officers of the Company such information and explanation as may be necessary for the performance of the duties of the Auditor.
103. Auditors shall, if so required by the Directors, make a report on the accounts of the Company during their tenure of office at the next annual general meeting following their appointment in the case of a company that is registered with the Registrar of Companies as an ordinary company, and at the next extraordinary general meeting following their appointment in the case of a company that is registered with the Registrar of Companies as an exempted company and at any other time during their term of office, upon request of the Directors or any general meeting of the Members.

#### NOTICES

- 104.** Except as otherwise provided in these Articles, notices shall be in writing. Notice may be given by the Company to any Member or Director either personally or by sending it by next-day or second-day courier service, fax, electronic mail or similar means to such Member or Director (as the case may be) or to the address of such Member or Director as shown in the Register of Members or the Register of Directors (as the case may be) (or where the notice is given by electronic mail by sending it to the electronic mail address provided by such Member or Director).
- 105.** Where a notice is sent by next-day or second-day courier service, service of the notice shall be deemed to be effected by properly addressing, pre paying and sending by next-day or second-day service through an internationally-recognized courier a letter containing the notice, with a confirmation of delivery, and to have been effected at the expiration of two (2) days (not including Saturdays or Sundays or public holidays) after the letter containing the same is sent as aforesaid. Where a notice is sent by fax to a fax number provided by the intended recipient, service of the notice shall be deemed to be effected when the receipt of the fax is acknowledged by the recipient. Where a notice is given by electronic mail to the electronic mail address provided by the intended recipient, service shall be deemed to be effected when the receipt of the electronic mail is acknowledged by the recipient.
- 106.** A notice may be given by the Company to the Person or Persons that the Company has been advised are entitled to a Share or Shares in consequence of the death or bankruptcy of a Member in the same manner as other notices that are required to be given under these Articles and shall be addressed to them by name, or by the title of representatives of the deceased, or trustee of the bankrupt, or by any like description at the address supplied for that purpose by the Persons claiming to be so entitled, or at the option of the Company, by giving the notice in any manner in which the same might have been given if the death or bankruptcy had not occurred.
- 107.** Notice of every general meeting shall be given in any manner hereinbefore authorised to every Person shown as a Member in the Register of Members on the record date for such meeting except that in the case of joint holders the notice shall be sufficient if given to the joint holder first named in the Register of Members and every Person upon whom the ownership of a Share devolves by reason of his or her being a legal personal representative or a trustee in bankruptcy of a Member of record where the Member of record but for his or her death or bankruptcy would be entitled to receive notice of the meeting, and no other Person shall be entitled to receive notices of general meetings.
- 108.** Whenever any notice is required by law or these Articles to be given to any Director, member of a committee or Member, a waiver thereof in writing, signed by the Person or Persons entitled to said notice, whether before or after the time stated therein, shall be deemed equivalent thereto.

#### WINDING UP

109. If the Company shall be wound up, assets available for distribution amongst the Members shall be distributed, in accordance with Article 7.
110. If the Company shall be wound up, the liquidator may, with the sanction of a Special Resolution of the Company and any other sanction required by the Statute, divide amongst the Members in kind the whole or any part of the assets of the Company (whether they shall consist of property of the same kind or not) and may for that purpose value any assets and, subject to Article 7, determine how the division shall be carried out as between the Members or different classes of Members. The liquidator may, with the like sanction, vest the whole or any part of such assets in trustees upon such trusts for the benefit of the Members as the liquidator, with the like sanction, shall think fit, but so that no Member shall be compelled to accept any asset upon which there is a liability.

#### INDEMNITY

111. To the maximum extent permitted by applicable law, the Directors and officers for the time being of the Company and any trustee for the time being acting in relation to any of the affairs of the Company and their heirs, executors, administrators and personal representatives respectively shall be indemnified out of the assets of the Company from and against all actions, proceedings, costs, charges, losses, damages and expenses that they or any of them shall or may incur or sustain by reason of any act done or omitted in or about the execution of their duty in their respective offices or trusts, except such (if any) as they shall incur or sustain by or through their own fraud or dishonesty, and no such Director or officer or trustee shall be answerable for the acts, receipts, neglects or defaults of any other Director or officer or trustee or for joining in any receipt for the sake of conformity or for the solvency or honesty of any banker or other Persons with whom any monies or effects belonging to the Company may be lodged or deposited for safe custody or for any insufficiency of any security upon which any monies of the Company may be invested or for any other loss or damage due to any such cause as aforesaid or which may happen in or about the execution of his or her office or trust unless the same shall happen through the fraud or dishonesty of such Director or officer or trustee. Except with respect to proceedings to enforce rights to indemnification pursuant to this Article, the Company shall indemnify any such indemnitee pursuant to this Article in connection with a proceeding (or part thereof) initiated by such indemnitee only if such proceeding (or part thereof) was authorized by the Board of Directors. The right to indemnification conferred in this Article shall include the right to be paid by the Company the expenses incurred in defending any such proceeding in advance of its final disposition to the maximum extent provided by, and subject to the requirements of, applicable law, so long as the indemnitee agrees with the Company to repay all amounts so advanced if it shall ultimately be determined by final judicial decision from which there is no further right to appeal that such indemnitee is not entitled to be indemnified for such expenses under this Article.
112. To the maximum extent permitted by applicable law, the Directors and officers for the time being of the Company and any trustee for the time being acting in relation to any of the affairs of the Company and their heirs, executors, administrators and personal representatives respectively shall not be personally liable to the Company or its Members for monetary damages for breach of their duty in their respective offices, except such (if any) as they shall incur or sustain by or through their own fraud or dishonesty respectively.

**FINANCIAL YEAR**

113. Unless the Directors otherwise prescribe, the financial year of the Company shall end on the 31st of December in each year and, following the year of incorporation, shall begin on the 1st of January in each year.

**TRANSFER BY WAY OF CONTINUATION**

114. If the Company is exempted as defined in the Statute, it shall, subject to the provisions of the Statute and with the approval of a Special Resolution and the written consent of the Majority Preferred Holders, have the power to register by way of continuation as a body corporate under the laws of any jurisdiction outside the Cayman Islands and to be deregistered in the Cayman Islands.

**DRAG ALONG RIGHTS**

115. On or after January 31, 2025, if more than 67% of holders of Preferred Shares (collectively, the “**Drag Holders**”) approve in writing a proposed Deemed Liquidation Event, Share Sale or other sale of the Company, whether structured as a merger, reorganization, asset sale, share sale, sale of control of the Company, or otherwise at a valuation no less than US\$500,000,000 (the “**Approved Sale**”), to any Person that is not a Drag Holder or an Affiliate of any Drag Holder (the “**Offeror**”), then at the request of the Drag Holders the Company shall promptly notify in writing each other holder of Equity Securities of the Company and the material terms and conditions of such proposed Approved Sale, whereupon each such holder shall, in accordance with instructions received from the Company at the direction of the Drag Holders:

(i) Sell, at the same time as the Drag Holders sell to the Offeror, in the Approved Sale, all of its Equity Securities of the Company or the same percentage of its Equity Securities of the Company as the Drag Holders sell, on the same terms and conditions as were agreed to by the Drag Holders; provided, however, that such terms and conditions, including with respect to price paid or received per Equity Security of the Company, may differ as between different classes of Equity Securities of the Company in accordance with their relative liquidation preferences as set forth in Article 7.2 and provided further that some Members may be given the right or opportunity to exchange or roll a portion of their Equity Securities of the Company for Equity Securities of the acquirer or an Affiliate thereof in the Approved Sale but in such event there shall be no obligation to afford such right or opportunity to all of the Members;

(ii) Vote all of its Equity Securities of the Company (a) in favor of such Approved Sale, (b) against any other consolidation, recapitalization, amalgamation, merger, sale of securities, sale of assets, business combination, or transaction that would interfere with, delay, restrict, or otherwise adversely affect such Approved Sale, and (c) against any action or agreement that would result in a breach of any covenant, representation or warranty or any other obligation or agreement of the Company under the definitive agreement(s) related to such Approved Sale or that could result in any of the conditions to the closing obligations under such agreement(s) not being fulfilled, and, in connection therewith, to be present (in person or by proxy) at all relevant meetings of the shareholders of the Company (or adjournments thereof) or to approve and execute all relevant written consents in lieu of a meeting.

(iii) Not exercise any dissenters' or appraisal rights under applicable law with respect to such Approved Sale.

(iv) Take all necessary actions in connection with the consummation of such Approved Sale as reasonably requested by the Drag Holders, including but not limited to the execution and delivery of any share transfer or other agreements prepared in connection with such Approved Sale, and the delivery, at the closing of such Approved Sale involving a sale of stock, of all certificates representing stock held or controlled by such Shareholder, duly endorsed for transfer or accompanied by a duly executed share transfer form, or affidavits and indemnity undertakings with respect to lost certificates.

(v) Restructure such Approved Sale, as and if reasonably requested by the Drag Holders, as a merger, consolidation, restructuring or similar transaction, or a sale of all or substantially all of the assets of the Company, or otherwise.

In the event that any Member fails for any reason to comply with this Article after reasonable notice thereof, such Member hereby grants an irrevocable power of attorney and proxy to any Director approving the Approved Sale to take all necessary actions and execute and deliver all documents deemed by such Director to be reasonably necessary to effectuate the terms hereof.

## Schedule A

Capitalized terms used in this Schedule A and not otherwise defined herein shall have the meaning ascribed to them below:

“Affiliate” means, with respect to a Person, any other Person that, directly or indirectly, Controls, is Controlled by or is under common Control with such Person. In the case of a Preferred Holder, the term “Affiliate” also includes (v) any Controlling shareholder of the Preferred Holder, (w) any of such shareholder’s or Preferred Holders’ general partners or limited partners, (x) the fund manager managing such shareholder or Preferred Holder (and general partners, limited partners and officers thereof) and other funds managed by such fund manager, and (y) trusts Controlled by or for the benefit of any such Person referred to in (v), (w) or (x).

“Business Day” means any day that is not a Saturday, Sunday, legal holiday or other day on which commercial banks are required or authorized by law to be closed in the PRC, Taiwan, or the United States.

“Control” of a given Person means the power or authority, whether exercised or not, to direct the business, management and policies of such Person, directly or indirectly, whether through the ownership of voting securities, by contract or otherwise; provided, that such power or authority shall conclusively be presumed to exist upon possession of beneficial ownership or power to direct the vote of more than fifty percent (50%) of the votes entitled to be cast at a meeting of the members or shareholders of such Person or power to control the composition of a majority of the board of directors of such Person. The terms “Controlled” and “Controlling” have meanings correlative to the foregoing.

“Equity Securities” means, with respect to any Person that is a legal entity, any and all shares of capital stock, membership interests, units, profits interests, ownership interests, equity interests, registered capital, and other equity securities of such Person, and any right, warrant, option, call, commitment, conversion privilege, preemptive right or other right to acquire any of the foregoing, or security convertible into, exchangeable or exercisable for any of the foregoing.

“Governmental Authority” means any government of any nation or any federation, province or state or any other political subdivision thereof, any entity, authority or body exercising executive, legislative, judicial, regulatory or administrative functions of or pertaining to government, including any governmental authority, agency, department, board, commission or instrumentality of any country, or any political subdivision thereof, any court, tribunal or arbitrator, and any self-regulatory organization.

“Governmental Order” means any applicable order, ruling, decision, verdict, decree, writ, subpoena, mandate, precept, command, directive, consent, approval, award, judgment, injunction or other similar determination or finding by, before or under the supervision of any Governmental Authority.

“HKIAC” means Hong Kong International Arbitration Centre.

“Preferred Holders” means holders of the Preferred Shares.



“Law” or “Laws” means any and all provisions of any applicable constitution, treaty, statute, law, regulation, ordinance, code, rule, or rule of common law, any governmental approval, concession, grant, franchise, license, agreement, directive, requirement, or other governmental restriction or any similar form of decision of, or determination by, or any formally issued written interpretation or administration of any of the foregoing by, any Governmental Authority, in each case as amended, and any and all applicable Governmental Orders.

“Majority Preferred Holders” means the holders of at least a majority of the voting power of the then outstanding Preferred Shares (voting together as a single class and calculated on as-converted basis).

“Ordinary Share Equivalents” means any Equity Security which is by its terms convertible into or exchangeable or exercisable for Ordinary Shares or other share capital of the Company, including without limitation, the Preferred Shares.

“Ordinary Shares” means the Company’s ordinary shares, par value US\$0.0001 per share.

“Person” means any individual, corporation, partnership, limited partnership, proprietorship, association, limited liability company, firm, trust, estate or other enterprise or entity.

“PRC” means the People’s Republic of China, but solely for the purposes of this Schedule, excluding Hong Kong, the Macau Special Administrative Region and the islands of Taiwan.

“Preferred Shares” means, collectively, the Series A Preferred Shares and the Series B Preferred Shares.

“Principal” means Lin Bioscience International Ltd..

“Shares” means the Ordinary Shares and the Preferred Shares.

## **1. Restriction on Transfers; Rights of First Refusal and Co-Sale Rights.**

### **1.1 Restriction on Transfers.**

A. **Principals and Holding Companies.** A Principal shall not directly or indirectly sell, assign, transfer, pledge, hypothecate, or otherwise encumber or dispose of in any way or otherwise grant any interest or right with respect to (“Transfer”) all or any part of any interest in any Equity Securities of the Company now or hereafter owned or held by such Principal unless Sections 1.2, 1.3 and 1.4 are complied with.

B. **Preferred Holders.** For the avoidance of doubt, Preferred Holders may freely Transfer any Equity Securities of the Company now or hereafter owned or held by them without limitation; provided that (i) no such Transfer shall result in any shares of the Company being transferred to or owned by, directly or indirectly, any competitor of the Company; (ii) such Transfer is effected in compliance with all applicable Laws and (iii) the transferee shall execute and deliver to the Company a deed of adherence or joinder becoming a party of the Shareholders Agreement as an “Investor” subject to the terms and conditions of the Shareholders Agreement (if not already so bound) upon and after such Transfer. The Company will update its register of members upon the consummation of any such permitted Transfer.

C. **Prohibited Transfers Void.** Any Transfer of Equity Securities of the Company not made in compliance with this Schedule shall be null and void as against the Company, shall not be recorded on the books of the Company and shall not be recognized by the Company.

D. **No Indirect Transfers.** Each Principal agrees not to circumvent or otherwise avoid the transfer restrictions or intent thereof set forth in this Schedule, whether by holding the Equity Securities of the Company indirectly through another Person or by causing or effecting, directly or indirectly, the Transfer or issuance of any Equity Securities by any such Person, or otherwise. Any purported Transfer, sale or issuance of any Equity Securities of any company held by a Principal holding shares in the Company (the "Holding Company") in contravention of this Schedule shall be void and ineffective for any and all purposes and shall not confer on any transferee or purported transferee any rights whatsoever, and no party (including without limitation, any Principal or Holding Company) shall recognize any such Transfer, sale or issuance.

## 1.2 Rights of First Refusal.

A. **Transfer Notice.** If a Principal (a "Transferor") proposes to Transfer any Equity Securities of the Company or any interest therein to one or more third parties, then the Transferor shall give the Company and each Preferred Holder written notice of the Transferor's intention to make the Transfer (the "Transfer Notice"), which shall include (i) a description of the Equity Securities to be transferred (the "Offered Shares"), (ii) the identity and address of the prospective transferee and (iii) the consideration and the material terms and conditions upon which the proposed Transfer is to be made. The Transfer Notice shall certify that the Transferor has received a definitive offer from the prospective transferee and in good faith believes a binding agreement for the Transfer is obtainable on the terms set forth in the Transfer Notice. The Transfer Notice shall also include a copy of any written proposal, term sheet or letter of intent or other agreement relating to the proposed Transfer.

B. **Option of Company.** The Company shall have an option for a period of ten (10) days following receipt of the Transfer Notice (the "Company Option Period") to elect to purchase all or a portion of the Offered Shares, at the same price and subject to the same terms and conditions as described in the Transfer Notice, exercisable by written notice to the Transferor (with a copy to the Preferred Holders).

C. **Option of Preferred Holders.**

(1) If the Company does not timely elect to purchase all of the Offered Shares pursuant to clause (B) above, then the Company shall deliver to each Preferred Holder written notice (the "Company Notice") thereof within ten (10) days after the expiration of the Company Option Period, and each such Preferred Holder shall have an option for a period of ten (10) days following receipt of the Company Notice (the "Option Period") to elect to purchase all or any portion of its respective Pro Rata Share of the remaining Offered Shares at the same price and subject to the same terms and conditions as described in the Transfer Notice, by notifying the Transferor and the Company in writing before expiration of the Option Period as to the number of such Offered Shares that it wishes to purchase.

(2) For the purposes of this Section 1.2C, a Preferred Holder's "Pro Rata Share" of such Offered Shares shall be equal to (i) the total number of such Offered Shares, multiplied by (ii) a fraction, the numerator of which shall be the aggregate number of Ordinary Shares held by such Preferred Holder on the date of the Transfer Notice (including all Preferred Shares held by such Preferred Holder on an as-converted to Ordinary Share basis) and the denominator of which shall be the total number of Ordinary Shares held by all Preferred Holders on such date (including all Preferred Shares held by such Preferred Holders on an as-converted to Ordinary Share basis).

(3) If any Preferred Holder fails to exercise its right to purchase its full Pro Rata Share of such Offered Shares, the Company shall deliver written notice thereof (the "Second Notice"), within five (5) days after the expiration of the Option Period, to the Transferor and to each Preferred Holder that elected to purchase its entire Pro Rata Share of the Offered Shares (an "Exercising Shareholder"). The Exercising Shareholders shall have a right of re-allotment, and may exercise an additional right to purchase such unpurchased Offered Shares by notifying the Transferor and the Company in writing within ten (10) days after receipt of the Second Notice (the "Re-allotment Period"); provided, however, that if the Exercising Shareholders desire to purchase in aggregate more than the number of such unpurchased Offered Shares, then such unpurchased Offered Shares will be allocated to the extent necessary among the Exercising Shareholders in accordance with their relative Pro Rata Shares.

(4) Subject to applicable securities Laws, each Preferred Holder shall be entitled to apportion Offered Shares to be purchased among its Affiliates, provided that such Preferred Holder notifies the Company and the Transferor in writing and such Affiliates shall execute and deliver such documents and take such other actions as may be necessary for such Affiliates to join in and be bound by the terms of the Shareholders Agreement as an "Investor" (if not already a party hereto) upon and after such Transfer.

D. **Procedure.** If the Company or any Preferred Holder gives the Transferor notice that it desires to purchase Offered Shares, and, as the case may be, any re-allotment, then payment for the Offered Shares to be purchased shall be made by check (if agreeable to the Transferor), or by wire transfer in immediately available funds of the appropriate currency, against delivery of such Offered Shares to be purchased, at a place agreed to by the Transferor, the Company (if it is a purchaser) and all the Exercising Shareholders (if they are purchasers) and at the time of the scheduled closing therefor, but if they cannot agree, then at the principal executive offices of the Company on the thirtieth (30<sup>th</sup>) day after the Company's receipt of the Transfer Notice, unless such notice contemplated a later closing date with the prospective third party transferee or unless the value of the purchase price has not yet been established pursuant to Section 1.2E, in which case the closing shall be on such later date or as provided in Section 1.2E(4). The Transferor shall have the right to terminate or withdraw any Transfer Notice and any intent to transfer Offered Shares at any time, whether or not any Preferred Holder has elected to purchase under this Section 1.2 any Offered Shares offered thereby. The Company will update its register of members upon the consummation of any such Transfer.

E. **Valuation of Property.**

(1) Should the purchase price specified in the Transfer Notice be payable in property other than cash or evidences of indebtedness, the Company and/or the Preferred Holders, as applicable, shall have the right to pay the purchase price in the form of cash equal in amount to the fair market value of such property.

(2) If the Transferor, the Company (if it is a purchaser), and the Exercising Shareholders holding a majority of the Offered Shares elected to be purchased by all Exercising Shareholders (if they are purchasers) cannot agree on such cash value within the Option Period, the valuation shall be made by an appraiser of internationally recognized standing jointly selected by agreement of such groups or, if they cannot agree on an appraiser within the Option Period, each such group shall select an appraiser of internationally recognized standing and such appraisers shall designate another appraiser of internationally recognized standing, whose appraisal shall be determinative of such value.

(3) The cost of such appraisal (and the cost, if any, of securing the appointment thereof by the HKIAC council) shall be shared equally by the Transferor, on the one hand, and the purchasers pro rata based on the number of Offered Shares such purchaser is purchasing, on the other hand.

(4) If the value of the purchase price offered by the prospective transferee is not determined within 30 days following the Company's receipt of the Transfer Notice from the Transferor, the closing of the purchase of Offered Shares by the Company and/or the Exercising Shareholders shall be held on or prior to the fifth (5<sup>th</sup>) Business Day after such valuation shall have been made pursuant to this Section 1.2E.

**1.3 Right of Co-Sale.**

A. To the extent the Company and the Preferred Holders do not exercise their respective rights of first refusal under Section 1.2 as to all or any of the Offered Shares proposed to be sold by the Transferor to the third party transferee identified in the Transfer Notice, the Transferor shall give notice thereof to each Preferred Holder not exercising any right of first refusal pursuant to Section 1.2 (the "Co-Sale Notice") (specifying in such Co-Sale Notice the number of remaining Offered Shares as well as the number of Shares that such Preferred Holder would be eligible to include in such sale pursuant to its co-sale right hereunder, and each such Preferred Holder shall have the right to participate in such sale, to the third party transferee identified in the Transfer Notice, of the remaining Offered Shares not purchased pursuant to Section 1.2, on the same terms and conditions as specified in the Transfer Notice (but in no event less favorable than the terms and conditions offered to the Transferor) (and for the same consideration on an as converted to ordinary share basis) by notifying the Transferor in writing within ten (10) days following the date of the Co-Sale Notice (each such electing Preferred Holder, a "Selling Shareholder"). Such Selling Shareholder's notice to the Transferor shall indicate the number of Equity Securities the Selling Shareholder wishes to sell under its right to participate. To the extent one or more Preferred Holders exercise such right of participation in accordance with the terms and conditions set forth below, the number of Offered Shares that the Transferor may sell in the Transfer to the third party transferee identified in the Transfer Notice shall be correspondingly reduced.

B. The total number of Equity Securities that each Selling Shareholder may elect to sell shall be equal to the product of (i) the aggregate number of the remaining Offered Shares being transferred to the third party transferee identified in the Transfer Notice after giving effect to the exercise of all rights of first refusal pursuant to Section 1.2 hereof, multiplied by (ii) a fraction, the numerator of which is the number of Ordinary Shares (including Preferred Shares on an as-converted to Ordinary Share basis) owned by such Selling Shareholder on the date of the Transfer Notice and the denominator of which is the total number of Ordinary Shares (including Preferred Shares on an as-converted to Ordinary Share basis) owned by the Transferor and all Selling Shareholders.

C. Each Selling Shareholder shall effect its participation in the sale by promptly delivering to the Transferor for transfer to the prospective purchaser, before the applicable closing, one or more certificates, properly endorsed for transfer, which represent the type and number of Equity Securities which such Selling Shareholder elects to sell; provided, however that if the prospective third party purchaser objects to the delivery of Ordinary Share Equivalents in lieu of Ordinary Shares, such Selling Shareholder shall only deliver Ordinary Shares (and therefore shall convert any such Ordinary Share Equivalents into Ordinary Shares) and certificates corresponding to such Ordinary Shares, and the Company shall effect any such conversion concurrent with the actual transfer of such shares to the purchaser and contingent on such transfer.

D. The share certificate or certificates that a Selling Shareholder delivers to the Transferor pursuant to this Section 1.3 shall be transferred to the prospective purchaser in consummation of the sale of the Equity Securities pursuant to the terms and conditions specified in the Transfer Notice, and the Transferor shall concurrently therewith remit to such Selling Shareholder that portion of the sale proceeds to which such Selling Shareholder is entitled by reason of its participation in such sale. The Company will update its register of members upon the consummation of any such Transfer.

E. To the extent that any prospective purchaser prohibits the participation by a Selling Shareholder exercising its co-sale rights hereunder in a proposed Transfer or otherwise refuses to purchase shares or other securities from a Selling Shareholder exercising its co-sale rights hereunder, the Transferor shall not sell to such prospective purchaser any Equity Securities unless and until, simultaneously with such sale, the Transferor shall purchase from such Selling Shareholder such shares or other securities that such Selling Shareholder would otherwise be entitled to sell to the prospective purchaser pursuant to its co-sale rights for the same consideration and on the same terms and conditions as the proposed transfer described in the Transfer Notice.

#### 1.4 Non-Exercise of Rights.

A. If the Company and the Preferred Holders do not elect to purchase all of the Offered Shares in accordance with Section 1.2, then, subject to the right of the Preferred Holders to exercise their rights to participate in the sale of Offered Shares within the time periods specified in Section 1.3, the Transferor shall have a period of sixty (60) days from the expiration of the Option Period in which to sell the remaining Offered Shares to the third party transferee identified in the Transfer Notice upon terms and conditions (including the purchase price) no more favorable to the purchaser than those specified in the Transfer Notice, so long as any such sale is effected in accordance with all applicable Laws. Each such transferee, prior to and as a condition to the consummation of any sale, shall execute and deliver to the Parties documents and other instruments assuming the obligations of such Transferor under the Shareholders Agreement with respect to the Offered Shares, and the transfer shall not be effective and shall not be recognized by any party until such documents and instruments are so executed and delivered.

B. In the event the Transferor does not consummate the sale of such Offered Shares to the third party transferee identified in the Transfer Notice within sixty (60) day period, the rights of the Preferred Holders under Section 1.2 and Section 1.3 shall be re-invoked and shall be applicable to each subsequent disposition of such Offered Shares by the Transferor until such rights lapse in accordance with the terms of this Schedule.

C. The exercise or non-exercise of the rights of the Preferred Holders under this Section 1 to purchase Equity Securities from a Transferor or participate in the sale of Equity Securities by a Transferor shall not adversely affect their rights to make subsequent purchases from the Transferor of Equity Securities or subsequently participate in sales of Equity Securities by the Transferor hereunder.

**1.5 Limitations to Rights of First Refusal and Co-Sale.** Subject to the requirements of applicable Law, the restrictions under Section 1.1 and the right of first refusal and right of co-sale of the Preferred Holders under Sections 1.2 and 1.3 shall not apply to (a) any sale of Equity Securities of the Company to the public pursuant to a Qualified IPO, (b) Transfer of any Equity Securities of the Company now or hereafter held by a Transferor to such Transferor's parents, children, spouse, or to a trustee, executor, or other fiduciary for the benefit of such Transferor or such Transferor's parents, children, spouse for bona fide estate planning purposes, and (c) Transfer of any Equity Securities of the Company now or hereafter held by an Transferor to its Affiliates (each such transferee pursuant to clause (b) above, a "Permitted Transferee", and collectively, the "Permitted Transferees"); provided, that (i) such Transfer is effected in compliance with all applicable Laws, (ii) respecting any transfer pursuant to clause (b) above, the Transferor has provided the Majority Preferred Holders reasonable evidence of the bona fide estate planning purposes for such transfer, and (iii) each such Permitted Transferee, prior to the completion of the Transfer, shall execute and deliver to the Company a deed of adherence or joinder becoming a party to the Shareholders Agreement as an "Investor" subject to the terms and conditions hereof (if not already so bound) assuming the obligations of such Transferor under this Schedule as a Transferor, with respect to the transferred Equity Securities; provided further, that the Transferor shall remain liable for any breach by such Permitted Transferee of any provision under this Schedule.

**THE COMPANIES ACT (AS REVISED)**  
**OF THE CAYMAN ISLANDS**  
**COMPANY LIMITED BY SHARES**  
**THIRD AMENDED AND RESTATED**  
**MEMORANDUM OF ASSOCIATION**  
**OF**  
**BELITE BIO, INC**

(Adopted by a Special Resolution passed on April 5, 2022 and effective immediately prior to the completion of the initial public offering of the Company's American Depositary Shares representing its Ordinary Shares)

1. The name of the Company is **Belite Bio, Inc.**
  2. The Registered Office of the Company will be at the offices of Maples Corporate Services Limited, PO Box 309, Uglund House, Grand Cayman, KY1-1104, Grand Cayman KY1-1104, Cayman Islands, or at such other location within the Cayman Islands as the Directors may from time to time determine.
  3. The objects for which the Company is established are unrestricted and the Company shall have full power and authority to carry out any object not prohibited by the Companies Act or any other law of the Cayman Islands.
  4. The Company shall have and be capable of exercising all the functions of a natural person of full capacity irrespective of any question of corporate benefit as provided by the Companies Act.
  5. The Company will not trade in the Cayman Islands with any person, firm or corporation except in furtherance of the business of the Company carried on outside the Cayman Islands; provided that nothing in this section shall be construed as to prevent the Company effecting and concluding contracts in the Cayman Islands, and exercising in the Cayman Islands all of its powers necessary for the carrying on of its business outside the Cayman Islands.
  6. The liability of each Shareholder is limited to the amount, if any, unpaid on the Shares held by such Shareholder.
  7. The authorised share capital of the Company is US\$50,000 divided into 500,000,000 shares comprising (i) 400,000,000 Ordinary Shares of a par value of US\$0.0001 each, and (ii) 100,000,000 undesignated shares of a par value of US\$0.0001 each, of such class or classes (however designated) as the board of directors may determine in accordance with Articles 8 and 9 of the Articles of Association of the Company. Subject to the Companies Act and the Articles, the Company shall have power to redeem or purchase any of its Shares and to increase or reduce its authorised share capital and to sub-divide or consolidate the said Shares or any of them and to issue all or any part of its capital whether original, redeemed, increased or reduced with or without any preference, priority, special privilege or other rights or subject to any postponement of rights or to any conditions or restrictions whatsoever and so that unless the conditions of issue shall otherwise expressly provide every issue of shares whether stated to be ordinary, preference or otherwise shall be subject to the powers on the part of the Company hereinbefore provided.
-

8. The Company has the power contained in the Companies Act to deregister in the Cayman Islands and be registered by way of continuation in some other jurisdiction.
9. Capitalised terms that are not defined in this Memorandum of Association bear the same meanings as those given in the Articles of Association of the Company.



**THE COMPANIES ACT (AS REVISED)**  
**OF THE CAYMAN ISLANDS**  
**COMPANY LIMITED BY SHARES**  
**THIRD AMENDED AND RESTATED**  
**ARTICLES OF ASSOCIATION**  
**OF**  
**BELITE BIO, INC**

(Adopted by a Special Resolution passed on April 5, 2022 and effective immediately prior to the completion of the initial public offering of the Company's American Depositary Shares representing its Ordinary Shares)

**TABLE A**

The regulations contained or incorporated in Table 'A' in the First Schedule of the Companies Act shall not apply to the Company and the following Articles shall comprise the Articles of Association of the Company.

**INTERPRETATION**

1. In these Articles the following defined terms will have the meanings ascribed to them, if not inconsistent with the subject or context:

<b>"ADS"</b>	means an American Depositary Share representing Ordinary Shares;
<b>"Articles"</b>	means these articles of association of the Company, as from time to time altered or added to in accordance with the Companies Act and these Articles;
<b>"Board" and "Board of Directors" and "Directors"</b>	means the directors of the Company for the time being, or as the case may be, the directors assembled as a board or as a committee thereof;
<b>"Chairman"</b>	means the chairman of the Board of Directors;
<b>"Class" or "Classes"</b>	means any class or classes of Shares as may from time to time be issued by the Company;

<b>“Commission”</b>	means the Securities and Exchange Commission of the United States of America or any other federal agency for the time being administering the Securities Act;
<b>“Communications Facilities”</b>	means technology (including without limitation video, video-conferencing, internet or online conferencing applications, telephone or teleconferencing and/or other video-communications, internet or online conferencing application or telecommunications facilities) by which natural persons are capable of hearing and being heard by each other;
<b>“Company”</b>	means <b>Belite Bio, Inc</b> , a Cayman Islands exempted company;
<b>“Companies Act”</b>	means the Companies Act (As Revised) of the Cayman Islands and any statutory amendment or re-enactment thereof;
<b>“Company’s Website”</b>	means the main corporate/investor relations website of the Company, the address or domain name of which has been disclosed in any registration statement filed by the Company with the Commission in connection with its initial public offering of ADSs, or which has otherwise been notified to Shareholders;
<b>“Designated Stock Exchange”</b>	means the stock exchange in the United States on which any Shares and ADSs are listed for trading;
<b>“Designated Stock Exchange Rules”</b>	means the relevant code, rules and regulations, as amended, from time to time, applicable as a result of the original and continued listing of any Shares or ADSs on the Designated Stock Exchange;
<b>“electronic”</b>	has the meaning given to it in the Electronic Transactions Act and any amendment thereto or re-enactments thereof for the time being in force and includes every other law incorporated therewith or substituted therefor;
<b>“electronic communication”</b>	means electronic posting to the Company’s Website, transmission to any number, address or internet website or other electronic delivery methods as otherwise decided and approved by not less than a majority of the vote of the Board;
<b>“Electronic Transactions Act”</b>	means the Electronic Transactions Act (As Revised) of the Cayman Islands and any statutory amendment or re-enactment thereof;
<b>“electronic record”</b>	has the meaning given to it in the Electronic Transactions Act and any amendment thereto or re-enactments thereof for the time being in force and includes every other law incorporated therewith or substituted therefor;

<b>“Memorandum of Association”</b>	means the memorandum of association of the Company, as amended or substituted from time to time;
<b>“Ordinary Resolution”</b>	means a resolution: <ul style="list-style-type: none"> <li>(a) passed by a simple majority of the votes cast by such Shareholders as, being entitled to do so, vote in person or, where proxies are allowed, by proxy or, in the case of corporations, by their duly authorised representatives, at a general meeting of the Company held in accordance with these Articles; or</li> <li>(b) approved in writing by all of the Shareholders entitled to vote at a general meeting of the Company in one or more instruments each signed by one or more of the Shareholders and the effective date of the resolution so adopted shall be the date on which the instrument, or the last of such instruments, if more than one, is executed;</li> </ul>
<b>“Ordinary Shares”</b>	means the ordinary shares in the capital of the Company with a par value of US\$0.0001 each;
<b>“paid up”</b>	means paid up as to the par value in respect of the issue of any Shares and includes credited as paid up;
<b>“Person”</b>	means any natural person, firm, company, joint venture, partnership, corporation, association or other entity (whether or not having a separate legal personality) or any of them as the context so requires;
<b>“Present”</b>	means, in respect of any Person, such Person's presence at a general meeting of Shareholders, which may be satisfied by means of such Person or, if a corporation or other non-natural Person, its duly authorized representative (or, in the case of any Shareholder, a proxy which has been validly appointed by such Shareholder in accordance with these Articles), being: (a) physically present at the venue specified in the notice convening the meeting; or (b) in the case of any meeting at which Communications Facilities are permitted in accordance with these Articles, including any Virtual Meeting, connected by Communication Facilities in accordance with procedures specified in the notice convening such general meeting; and <b>“Presence”</b> shall be construed accordingly;
<b>“Register”</b>	means the register of Members of the Company maintained in accordance with the Companies Act;
<b>“Registered Office”</b>	means the registered office of the Company as required by the Companies Act;

<b>“Seal”</b>	means the common seal of the Company (if adopted) including any facsimile thereof;
<b>“Secretary”</b>	means any Person appointed by the Directors to perform any of the duties of the secretary of the Company;
<b>“Securities Act”</b>	means the Securities Act of 1933 of the United States of America, as amended, or any similar federal statute and the rules and regulations of the Commission thereunder, all as the same shall be in effect at the time;
<b>“Share”</b>	means a share in the capital of the Company. All references to “Shares” herein shall be deemed to be Shares of any or all Classes as the context may require. For the avoidance of doubt in these Articles the expression “Share” shall include a fraction of a Share;
<b>“Shareholder” or “Member”</b>	means a Person who is registered as the holder of one or more Shares in the Register;
<b>“Share Premium Account”</b>	means the share premium account established in accordance with these Articles and the Companies Act;
<b>“signed”</b>	means bearing a signature or representation of a signature affixed by mechanical means or an electronic symbol or process attached to or logically associated with an electronic communication and executed or adopted by a Person with the intent to sign the electronic communication;
<b>“Special Resolution”</b>	means a special resolution of the Company passed in accordance with the Companies Act, being a resolution: <ul style="list-style-type: none"> <li>(a) passed by not less than two-thirds of the votes cast by such Shareholders as, being entitled to do so, vote in person or, where proxies are allowed, by proxy or, in the case of corporations, by their duly authorised representatives, at a general meeting of the Company of which notice specifying the intention to propose the resolution as a special resolution has been duly given; or</li> <li>(b) approved in writing by all of the Shareholders entitled to vote at a general meeting of the Company in one or more instruments each signed by one or more of the Shareholders and the effective date of the special resolution so adopted shall be the date on which the instrument or the last of such instruments, if more than one, is executed;</li> </ul>
<b>“Treasury Share”</b>	means a Share held in the name of the Company as a treasury share in accordance with the Companies Act;

**“United States”**

means the United States of America, its territories, its possessions and all areas subject to its jurisdiction; and

**“Virtual Meeting”**

means any general meeting of the Shareholders at which the Shareholders (and any other permitted participants of such meeting, including without limitation the chairman of the meeting and any Directors) are permitted to be Present solely by means of Communications Facilities.

2. In these Articles, save where the context requires otherwise:

- (a) words importing the singular number shall include the plural number and vice versa;
- (b) words importing the masculine gender only shall include the feminine gender and any Person as the context may require;
- (c) the word "may" shall be construed as permissive and the word "shall" shall be construed as imperative;
- (d) reference to a dollar or dollars (or US\$) and to a cent or cents is reference to dollars and cents of the United States of America;
- (e) reference to a statutory enactment shall include reference to any amendment or re-enactment thereof for the time being in force;
- (f) reference to any determination by the Directors shall be construed as a determination by the Directors in their sole and absolute discretion and shall be applicable either generally or in any particular case;
- (g) reference to "in writing" shall be construed as written or represented by any means reproducible in writing, including any form of print, lithograph, email, facsimile, photograph or telex or represented by any other substitute or format for storage or transmission for writing including in the form of an electronic record or partly one and partly another;
- (h) any requirements as to delivery under the Articles include delivery in the form of an electronic record or an electronic communication;
- (i) any requirements as to execution or signature under the Articles, including the execution of the Articles themselves, can be satisfied in the form of an electronic signature as defined in the Electronic Transaction Act; and
- (j) Sections 8 and 19(3) of the Electronic Transactions Act shall not apply.

3. Subject to the last two preceding Articles, any words defined in the Companies Act shall, if not inconsistent with the subject or context, bear the same meaning in these Articles.

**PRELIMINARY**

4. The business of the Company may be conducted as the Directors see fit.
5. The Registered Office shall be at such address in the Cayman Islands as the Directors may from time to time determine. The Company may in addition establish and maintain such other offices and places of business and agencies in such places as the Directors may from time to time determine.
6. The expenses incurred in the formation of the Company and in connection with the offer for subscription and issue of Shares shall be paid by the Company. Such expenses may be amortised over such period as the Directors may determine and the amount so paid shall be charged against income and/or capital in the accounts of the Company as the Directors shall determine.
7. The Directors shall keep, or cause to be kept, the Register at such place or (subject to compliance with the Companies Act and these Articles) places as the Directors may from time to time determine and, in the absence of any such determination, the Register shall be kept at the Registered Office.

**SHARES**

8. Subject to these Articles, all Shares for the time being unissued shall be under the control of the Directors who may, in their absolute discretion and without the approval of the Members, cause the Company to:
  - (a) issue, allot and dispose of Shares (including, without limitation, preferred shares) (whether in certificated form or non-certificated form) to such Persons, in such manner, on such terms and having such rights and being subject to such restrictions as they may from time to time determine;
  - (b) grant rights over Shares or other securities to be issued in one or more classes or series as they deem necessary or appropriate and determine the designations, powers, preferences, privileges and other rights attaching to such Shares or securities, including dividend rights, voting rights, conversion rights, terms of redemption and liquidation preferences, any or all of which may be greater than the powers, preferences, privileges and rights associated with the then issued and outstanding Shares, at such times and on such other terms as they think proper; and
  - (c) grant options with respect to Shares and issue warrants, convertible securities or similar instruments with respect thereto.

and, for such purposes, the Directors may reserve an appropriate number of Shares for the time being unissued.

9. The Directors, or the Shareholders by Ordinary Resolution, may authorise the division of Shares into any number of Classes and the different Classes shall be authorised, established and designated (or re-designated as the case may be) and the variations in the relative rights (including, without limitation, voting, dividend and redemption rights), restrictions, preferences, privileges and payment obligations as between the different Classes (if any) may be fixed and determined by the Directors or by the Shareholders by Ordinary Resolution. The Directors may issue Shares with such preferred or other rights, all or any of which may be greater than the rights of Ordinary Shares, at such time and on such terms as they may think appropriate. Notwithstanding Article 12, the Directors may issue from time to time, out of the authorised share capital of the Company (other than the authorised but unissued Ordinary Shares), series of preferred shares in their absolute discretion and without approval of the Members; provided, however, before any preferred shares of any such series are issued, the Directors shall by resolution of Directors determine, with respect to any series of preferred shares, the terms and rights of that series, including:
- (a) the designation of such series, the number of preferred shares to constitute such series and the subscription price thereof if different from the par value thereof;
  - (b) whether the preferred shares of such series shall have voting rights, in addition to any voting rights provided by law, and, if so, the terms of such voting rights, which may be general or limited;
  - (c) the dividends, if any, payable on such series, whether any such dividends shall be cumulative, and, if so, from what dates, the conditions and dates upon which such dividends shall be payable, and the preference or relation which such dividends shall bear to the dividends payable on any shares of any other class or any other series of shares;
  - (d) whether the preferred shares of such series shall be subject to redemption by the Company, and, if so, the times, prices and other conditions of such redemption;
  - (e) whether the preferred shares of such series shall have any rights to receive any part of the assets available for distribution amongst the Members upon the liquidation of the Company, and, if so, the terms of such liquidation preference, and the relation which such liquidation preference shall bear to the entitlements of the holders of shares of any other class or any other series of shares;
  - (f) whether the preferred shares of such series shall be subject to the operation of a retirement or sinking fund and, if so, the extent to and manner in which any such retirement or sinking fund shall be applied to the purchase or redemption of the preferred shares of such series for retirement or other corporate purposes and the terms and provisions relative to the operation thereof;
  - (g) whether the preferred shares of such series shall be convertible into, or exchangeable for, shares of any other class or any other series of preferred shares or any other securities and, if so, the price or prices or the rate or rates of conversion or exchange and the method, if any, of adjusting the same, and any other terms and conditions of conversion or exchange;
  - (h) the limitations and restrictions, if any, to be effective while any preferred shares of such series are outstanding upon the payment of dividends or the making of other distributions on, and upon the purchase, redemption or other acquisition by the Company of, the existing shares or shares of any other class of shares or any other series of preferred shares;

(i) the conditions or restrictions, if any, upon the creation of indebtedness of the Company or upon the issue of any additional shares, including additional shares of such series or of any other class of shares or any other series of preferred shares; and

(j) any other powers, preferences and relative, participating, optional and other special rights, and any qualifications, limitations and restrictions thereof;

and, for such purposes, the Directors may reserve an appropriate number of Shares for the time being unissued. The Company is not obliged to issue, allot or dispose of Shares if it is, in the opinion of the Directors, unlawful or impracticable. The Company shall not issue Shares to bearer.

10. The Company may insofar as may be permitted by law, pay a commission to any Person in consideration of his subscribing or agreeing to subscribe whether absolutely or conditionally for any Shares. Such commissions may be satisfied by the payment of cash or the lodgement of fully or partly paid-up Shares or partly in one way and partly in the other. The Company may also pay such brokerage as may be lawful on any issue of Shares.

11. The Directors may refuse to accept any application for Shares, and may accept any application in whole or in part, for any reason or for no reason.

#### MODIFICATION OF RIGHTS

12. Whenever the capital of the Company is divided into different Classes (and as otherwise determined by the Directors), the rights attached to any such Class may, subject to any rights or restrictions for the time being attached to any Class, only be materially adversely varied or abrogated with the consent in writing of the holders of not less than a majority of the issued Shares of that Class or with the sanction of an Ordinary Resolution passed at a separate meeting of the holders of the Shares of that Class. To every such separate meeting all the provisions of these Articles relating to general meetings of the Company or to the proceedings thereat shall, *mutatis mutandis*, apply, except that the necessary quorum shall be one or more Persons holding or representing by proxy at least one-third in nominal or par value amount of the issued Shares of the relevant Class (but so that if at any adjourned meeting of such holders a quorum as above defined is not present, those Shareholders who are present shall form a quorum) and that, subject to any rights or restrictions for the time being attached to the Shares of that Class, every Shareholder of the Class shall on a poll have one vote for each Share of the Class held by him. For the purposes of this Article the Directors may treat all the Classes or any two or more Classes as forming one Class if they consider that all such Classes would be affected in the same way by the proposals under consideration, but in any other case shall treat them as separate Classes.

13. The rights conferred upon the holders of the Shares of any Class issued with preferred or other rights shall not, subject to any rights or restrictions for the time being attached to the Shares of that Class, be deemed to be materially adversely varied or abrogated by, inter alia, the creation, allotment or issue of further Shares ranking *pari passu* with or subsequent to them or the redemption or purchase of any Shares of any Class by the Company. The rights of the holders of Shares shall not be deemed to be materially adversely varied or abrogated by the creation or issue of Shares with preferred or other rights including, without limitation, the creation of Shares with enhanced or weighted voting rights.



#### **CERTIFICATES**

14. Every Person whose name is entered as a Member in the Register may, without payment and upon its written request, request a certificate within one calendar month after allotment or lodgement of transfer (or within such other period as the conditions of issue shall provide) in the form determined by the Directors. All certificates shall specify the Share or Shares held by that Person, provided that in respect of a Share or Shares held jointly by several Persons the Company shall not be bound to issue more than one certificate, and delivery of a certificate for a Share to one of several joint holders shall be sufficient delivery to all. All certificates for Shares shall be delivered personally or sent through the post addressed to the Member entitled thereto at such Member's address notified by such Member to the Company prior to such delivery, or if absent of such notification, at the Member's registered address as appearing in the Register.
15. Every share certificate of the Company shall bear legends required under the applicable laws, including the Securities Act.
16. Any two or more certificates representing Shares of any one Class held by any Member may at the Member's request be cancelled and a single new certificate for such Shares issued in lieu on payment (if the Directors shall so require) of one U.S. dollar (US\$1.00) or such smaller sum as the Directors shall determine.
17. If a share certificate shall be damaged or defaced or alleged to have been lost, stolen or destroyed, a new certificate representing the same Shares may be issued to the relevant Member upon request, subject to delivery up of the old certificate or (if alleged to have been lost, stolen or destroyed) compliance with such conditions as to evidence and indemnity and the payment of out-of-pocket expenses of the Company in connection with the request as the Directors may think fit.
18. In the event that Shares are held jointly by several Persons, any request may be made by any one of the joint holders and if so made shall be binding on all of the joint holders.

#### **FRACTIONAL SHARES**

19. The Directors may issue fractions of a Share and, if so issued, a fraction of a Share shall be subject to and carry the corresponding fraction of liabilities (whether with respect to nominal or par value, premium, contributions, calls or otherwise), limitations, preferences, privileges, qualifications, restrictions, rights (including, without prejudice to the generality of the foregoing, voting and participation rights) and other attributes of a whole Share. If more than one fraction of a Share of the same Class is issued to or acquired by the same Shareholder such fractions shall be accumulated.

#### LIEN

20. The Company has a first and paramount lien on every Share (whether or not fully paid) for all amounts (whether presently payable or not) payable at a fixed time or called in respect of that Share. The Company also has a first and paramount lien on every Share registered in the name of a Person indebted or under liability to the Company (whether he is the sole registered holder of a Share or one of two or more joint holders) for all amounts owing by him or his estate to the Company (whether or not presently payable). The Directors may at any time declare a Share to be wholly or in part exempt from the provisions of this Article. The Company's lien on a Share extends to any amount payable in respect of it, including but not limited to dividends.
21. The Company may sell, in such manner as the Directors in their absolute discretion think fit, any Share on which the Company has a lien, but no sale shall be made unless an amount in respect of which the lien exists is presently payable nor until the expiration of fourteen calendar days after a notice in writing, demanding payment of such part of the amount in respect of which the lien exists as is presently payable, has been given to the registered holder for the time being of the Share, or the Persons entitled thereto by reason of his death or bankruptcy.
22. For giving effect to any such sale the Directors may authorise a Person to transfer the Shares sold to the purchaser thereof. The purchaser shall be registered as the holder of the Shares comprised in any such transfer and he shall not be bound to see to the application of the purchase money, nor shall his title to the Shares be affected by any irregularity or invalidity in the proceedings in reference to the sale.
23. The proceeds of the sale after deduction of expenses, fees and commissions incurred by the Company shall be received by the Company and applied in payment of such part of the amount in respect of which the lien exists as is presently payable, and the residue shall (subject to a like lien for sums not presently payable as existed upon the Shares prior to the sale) be paid to the Person entitled to the Shares immediately prior to the sale.

#### CALLS ON SHARES

24. Subject to the terms of the allotment, the Directors may from time to time make calls upon the Shareholders in respect of any moneys unpaid on their Shares, and each Shareholder shall (subject to receiving at least fourteen calendar days' notice specifying the time or times of payment) pay to the Company at the time or times so specified the amount called on such Shares. A call shall be deemed to have been made at the time when the resolution of the Directors authorising such call was passed.
25. The joint holders of a Share shall be jointly and severally liable to pay calls in respect thereof.
26. If a sum called in respect of a Share is not paid before or on the day appointed for payment thereof, the Person from whom the sum is due shall pay interest upon the sum at the rate of eight percent per annum from the day appointed for the payment thereof to the time of the actual payment, but the Directors shall be at liberty to waive payment of that interest wholly or in part.

27. The provisions of these Articles as to the liability of joint holders and as to payment of interest shall apply in the case of non-payment of any sum which, by the terms of issue of a Share, becomes payable at a fixed time, whether on account of the amount of the Share, or by way of premium, as if the same had become payable by virtue of a call duly made and notified.
28. The Directors may make arrangements with respect to the issue of partly paid Shares for a difference between the Shareholders, or the particular Shares, in the amount of calls to be paid and in the times of payment.
29. The Directors may, if they think fit, receive from any Shareholder willing to advance the same all or any part of the moneys uncalled and unpaid upon any partly paid Shares held by him, and upon all or any of the moneys so advanced may (until the same would, but for such advance, become presently payable) pay interest at such rate (not exceeding without the sanction of an Ordinary Resolution, eight percent per annum) as may be agreed upon between the Shareholder paying the sum in advance and the Directors. No such sum paid in advance of calls shall entitle the Member paying such sum to any portion of a dividend declared in respect of any period prior to the date upon which such sum would, but for such payment, become presently payable.

#### **FORFEITURE OF SHARES**

30. If a Shareholder fails to pay any call or instalment of a call in respect of partly paid Shares on the day appointed for payment, the Directors may, at any time thereafter during such time as any part of such call or instalment remains unpaid, serve a notice on him requiring payment of so much of the call or instalment as is unpaid, together with any interest which may have accrued.
31. The notice shall name a further day (not earlier than the expiration of fourteen calendar days from the date of the notice) on or before which the payment required by the notice is to be made, and shall state that in the event of non-payment at or before the time appointed, the Shares in respect of which the call was made will be liable to be forfeited.
32. If the requirements of any such notice as aforesaid are not complied with, any Share in respect of which the notice has been given may at any time thereafter, before the payment required by notice has been made, be forfeited by a resolution of the Directors to that effect.
33. A forfeited Share may be sold or otherwise disposed of on such terms and in such manner as the Directors think fit, and at any time before a sale or disposition the forfeiture may be cancelled on such terms as the Directors think fit.
34. A Person whose Shares have been forfeited shall cease to be a Shareholder in respect of the forfeited Shares, but shall, notwithstanding, remain liable to pay to the Company all moneys which at the date of forfeiture were payable by him to the Company in respect of the Shares forfeited, but his liability shall cease if and when the Company receives payment in full of the amount unpaid on the Shares forfeited.

35. A certificate in writing under the hand of a Director that a Share has been duly forfeited on a date stated in the certificate shall be conclusive evidence of the facts in the declaration as against all Persons claiming to be entitled to the Share.
36. The Company may receive the consideration, if any, given for a Share on any sale or disposition thereof pursuant to the provisions of these Articles as to forfeiture and may execute a transfer of the Share in favour of the Person to whom the Share is sold or disposed of and that Person shall be registered as the holder of the Share and shall not be bound to see to the application of the purchase money, if any, nor shall his title to the Shares be affected by any irregularity or invalidity in the proceedings in reference to the disposition or sale.
37. The provisions of these Articles as to forfeiture shall apply in the case of non-payment of any sum which by the terms of issue of a Share becomes due and payable, whether on account of the amount of the Share, or by way of premium, as if the same had been payable by virtue of a call duly made and notified.

#### TRANSFER OF SHARES

38. The instrument of transfer of any Share shall be in writing and in any usual or common form or such other form as the Directors may, in their absolute discretion, approve and be executed by or on behalf of the transferor and if in respect of a nil or partly paid up Share, or if so required by the Directors, shall also be executed on behalf of the transferee and shall be accompanied by the certificate (if any) of the Shares to which it relates and such other evidence as the Directors may reasonably require to show the right of the transferor to make the transfer. The transferor shall be deemed to remain a Shareholder until the name of the transferee is entered in the Register in respect of the relevant Shares.
39. The Directors may in their absolute discretion decline to register any transfer of Shares which is not fully paid up or on which the Company has a lien.
- (a) The Directors may also decline to register any transfer of any Share unless:
- (i) the instrument of transfer is lodged with the Company, accompanied by the certificate for the Shares to which it relates and such other evidence as the Board may reasonably require to show the right of the transferor to make the transfer;
  - (ii) the instrument of transfer is in respect of only one Class of Shares;
  - (iii) the instrument of transfer is properly stamped, if required;
  - (iv) in the case of a transfer to joint holders, the number of joint holders to whom the Share is to be transferred does not exceed four; and
  - (v) a fee of such maximum sum as the Designated Stock Exchange may determine to be payable, or such lesser sum as the Board of Directors may from time to time require, is paid to the Company in respect thereof.

40. The registration of transfers may, on ten calendar days' notice being given by advertisement in such one or more newspapers, by electronic means or by any other means in accordance with the Designated Stock Exchange Rules, be suspended and the Register closed at such times and for such periods as the Directors may, in their absolute discretion, from time to time determine, provided always that such registration of transfer shall not be suspended nor the Register closed for more than thirty calendar days in any calendar year.
41. All instruments of transfer that are registered shall be retained by the Company. If the Directors refuse to register a transfer of any Shares, they shall within three calendar months after the date on which the transfer was lodged with the Company send notice of the refusal to each of the transferor and the transferee.

#### **TRANSMISSION OF SHARES**

42. The legal personal representative of a deceased sole holder of a Share shall be the only Person recognised by the Company as having any title to the Share. In the case of a Share registered in the name of two or more holders, the survivors or survivor, or the legal personal representatives of the deceased survivor, shall be the only Person recognised by the Company as having any title to the Share.
43. Any Person becoming entitled to a Share in consequence of the death or bankruptcy of a Shareholder shall, upon such evidence being produced as may from time to time be required by the Directors, have the right either to be registered as a Shareholder in respect of the Share or, instead of being registered himself, to make such transfer of the Share as the deceased or bankrupt Person could have made; but the Directors shall, in either case, have the same right to decline or suspend registration as they would have had in the case of a transfer of the Share by the deceased or bankrupt Person before the death or bankruptcy.
44. A Person becoming entitled to a Share by reason of the death or bankruptcy of a Shareholder shall be entitled to the same dividends and other advantages to which he would be entitled if he were the registered Shareholder, except that he shall not, before being registered as a Shareholder in respect of the Share, be entitled in respect of it to exercise any right conferred by membership in relation to meetings of the Company, provided however, that the Directors may at any time give notice requiring any such Person to elect either to be registered himself or to transfer the Share, and if the notice is not complied with within ninety calendar days, the Directors may thereafter withhold payment of all dividends, bonuses or other monies payable in respect of the Share until the requirements of the notice have been complied with.

#### **REGISTRATION OF EMPOWERING INSTRUMENTS**

45. The Company shall be entitled to charge a fee not exceeding one U.S. dollar (US\$1.00) on the registration of every probate, letters of administration, certificate of death or marriage, power of attorney, notice in lieu of distringas, or other instrument.

#### ALTERATION OF SHARE CAPITAL

46. The Company may from time to time by Ordinary Resolution increase the share capital by such sum, to be divided into Shares of such Classes and amount, as the resolution shall prescribe and with such rights, priorities and privileges annexed thereto, as the resolution shall prescribe.
47. The Company may by Ordinary Resolution:
- (a) increase its share capital by new Shares of such amount as it thinks expedient;
  - (b) consolidate and divide all or any of its share capital into Shares of a larger amount than its existing Shares;
  - (c) subdivide its Shares, or any of them, into Shares of an amount smaller than that fixed by the Memorandum, provided that in the subdivision the proportion between the amount paid and the amount, if any, unpaid on each reduced Share shall be the same as it was in case of the Share from which the reduced Share is derived; and
  - (d) cancel any Shares that, at the date of the passing of the resolution, have not been taken or agreed to be taken by any Person and diminish the amount of its share capital by the amount of the Shares so cancelled.

The Board may settle as they consider expedient any difficulty which arises in relation to any consolidation and division under the preceding Article and in particular but without prejudice to the generality of the foregoing may issue certificates in respect of fractions of shares or arrange for the sale of the shares representing fractions and the distribution of the net proceeds of sale (after deduction of the expenses of such sale) in due proportion amongst the Members who would have been entitled to the fractions, and for this purpose the Board may authorize some person to transfer the shares representing fractions to their purchaser or resolve that such net proceeds be paid to the Company for the Company's benefit. Such purchaser will not be bound to see to the application of the purchase money nor will his title to the shares be affected by any irregularity or invalidity in the proceedings relating to the sale.

48. The Company may by Special Resolution reduce its share capital and any capital redemption reserve in any manner authorised by law.

#### REDEMPTION, PURCHASE AND SURRENDER OF SHARES

49. Subject to the provisions of the Companies Act and these Articles, the Company may:
- (a) issue Shares that are to be redeemed or are liable to be redeemed at the option of the Shareholder or the Company. The redemption of Shares shall be effected in such manner and upon such terms as may be determined, before the issue of such Shares, by either the Board or by the Shareholders by Ordinary Resolution;
  - (b) redeem or purchase its own Shares (including any redeemable Shares) on such terms and in such manner and terms as have been approved by the Board or by the Members by Ordinary Resolution, or are otherwise authorised by these Articles; and

(c) make a payment in respect of the redemption or purchase of its own Shares in any manner permitted by the Companies Act, including out of capital.

50. The purchase of any Share shall not oblige the Company to purchase any other Share other than as may be required pursuant to applicable law and any other contractual obligations of the Company.
51. The holder of the Shares being purchased shall be bound to deliver up to the Company the certificate(s) (if any) thereof for cancellation and thereupon the Company shall pay to him the purchase or redemption monies or consideration in respect thereof. Any Share in respect of which notice of redemption has been given shall not be entitled to participate in the profits of the Company in respect of the period after the date specified as the date of redemption in the notice of redemption.
52. The Directors may accept the surrender for no consideration of any fully paid Share.

#### **TREASURY SHARES**

53. The Directors may, prior to the purchase, redemption or surrender of any Share, determine that such Share shall be held as a Treasury Share.
54. The Directors may determine to cancel a Treasury Share or transfer a Treasury Share on such terms as they think proper (including, without limitation, for nil consideration). In the event that the Directors do not specify that the relevant Shares are to be held as Treasury Shares, such Shares shall be cancelled.
55. No dividend may be declared or paid, and no other distribution (whether in cash or otherwise) of the Company's assets (including any distribution of assets to Shareholders on a winding up) may be declared or paid in respect of a Treasury Share.
56. The Company shall be entered in the Register as the holder of the Treasury Shares provided that:
- (a) the Company shall not be treated as a Shareholder for any purpose and shall not exercise any right in respect of the Treasury Shares, and any purported exercise of such a right shall be void;
  - (b) a Treasury Share shall not be voted, directly or indirectly, at any meeting of the Company and shall not be counted in determining the total number of issued shares at any given time, whether for the purposes of these Articles or the Companies Act, save that an allotment of Shares as fully paid bonus shares in respect of a Treasury Share is permitted and Shares allotted as fully paid bonus shares in respect of a treasury share shall be treated as Treasury Shares.
57. Treasury Shares may be disposed of by the Company on such terms and conditions as determined by the Directors.

## GENERAL MEETINGS

58. All general meetings other than annual general meetings shall be called extraordinary general meetings.
59. The Company may (but shall not be obliged to, unless as required by applicable law or Designated Stock Exchange Rules) in each calendar year hold a general meeting as its annual general meeting and shall specify the meeting as such in the notices calling it. The annual general meeting shall be held at such time and place as may be determined by the Directors.
- (a) At these meetings the report of the Directors (if any) shall be presented.
60. The Chairman or a majority of the Directors may call general meetings, and they shall on a Shareholders' requisition forthwith proceed to convene an extraordinary general meeting of the Company.
- (a) A Shareholders' requisition is a requisition of Members holding at the date of deposit of the requisition Shares which carry in aggregate not less than one-third (1/3) of all votes attaching to all issued and outstanding Shares of the Company that as at the date of the deposit carry the right to vote at general meetings of the Company.
- (b) The requisition must state the objects of the meeting and must be signed by the requisitionists and deposited at the Registered Office, and may consist of several documents in like form each signed by one or more requisitionists.
- (c) If there are no Directors as at the date of the deposit of the Shareholders' requisition, or if the Directors do not within twenty-one calendar days from the date of the deposit of the requisition duly proceed to convene a general meeting to be held within a further twenty-one calendar days, the requisitionists, or any of them representing more than one-half of the total voting rights of all of them, may themselves convene a general meeting, but any meeting so convened shall not be held after the expiration of three calendar months after the expiration of the said twenty-one calendar days.
- (d) A general meeting convened as aforesaid by requisitionists shall be convened in the same manner as nearly as possible as that in which general meetings are to be convened by Directors.

## NOTICE OF GENERAL MEETINGS

61. At least seven (7) calendar days' notice shall be given for any general meeting. Every notice shall be exclusive of the day on which it is given or deemed to be given and of the day for which it is given and shall specify the place (except in the case of a Virtual Meeting), the day and the hour of the meeting and the general nature of the business and shall be given in the manner hereinafter mentioned or in such other manner if any as may be prescribed by the Company, provided that a general meeting of the Company shall, whether or not the notice specified in this Article has been given and whether or not the provisions of these Articles regarding general meetings have been complied with, be deemed to have been duly convened if it is so agreed:
- (a) in the case of an annual general meeting, by all the Shareholders (or their proxies) entitled to attend and vote thereat; and



(b) in the case of an extraordinary general meeting, by two-thirds (2/3rd) of the Shareholders having a right to attend and vote at the meeting, Present at the meeting.

62. The accidental omission to give notice of a meeting to or the non-receipt of a notice of a meeting by any Shareholder shall not invalidate the proceedings at any meeting.

#### PROCEEDINGS AT GENERAL MEETINGS

63. No business except for the appointment of a chairman for the meeting shall be transacted at any general meeting unless a quorum of Shareholders is Present at the time when the meeting proceeds to business. One or more Shareholders holding Shares which carry in aggregate (or representing by proxy) not less than one-third of all votes attaching to all Shares in issue and entitled to vote at such general meeting, Present at the meeting, shall be a quorum for all purposes.

64. If within half an hour from the time appointed for the meeting a quorum is not Present, the meeting shall be dissolved.

65. If the Directors so determine in respect of a specific general meeting or all general meetings of the Company, Presence at the relevant general meeting may be by means of Communications Facilities. The Directors may determine that any general meeting may be held as a Virtual Meeting. The notice of any general meeting at which Communications Facilities may be utilized (including any Virtual Meeting) must disclose the Communications Facilities that will be used, including the procedures to be followed by any Shareholder or other participant of the general meeting utilizing such Communications Facilities.

66. The Chairman, if any, shall preside as chairman at every general meeting of the Company.

67. If there is no such Chairman, or if at any general meeting he is not Present within fifteen minutes after the time appointed for holding the meeting or is unwilling to act as chairman of the meeting, any Director or Person nominated by the Directors shall preside as chairman of that meeting, failing which the Shareholders Present shall choose any Person Present to be chairman of that meeting.

68. The chairman of any general meeting shall be entitled to participate at any such general meeting by Communication Facilities, and to act as the chairman of such general meeting, in which event the following provisions shall apply:

(a) he shall be deemed to be Present at the general meeting; and

(b) if the Communication Facilities fail to enable the chairman of the general meeting to hear and be heard by other Persons participating in the meeting, then the other Directors Present at the general meeting shall choose another Director Present to act as chairman of the general meeting for (or for the remainder of) the general meeting; provided that if no other Director is Present at the general meeting, or if all the Directors Present decline to take the chair, then the general meeting shall be automatically adjourned to the same day in the next week and at such time and place as shall be decided by the Directors.

69. The chairman of any general meeting at which a quorum is Present may with the consent of the meeting (and shall if so directed by the meeting) adjourn the meeting from time to time and from place to place, but no business shall be transacted at any adjourned meeting other than the business left unfinished at the meeting from which the adjournment took place. When a meeting, or adjourned meeting, is adjourned for fourteen calendar days or more, notice of the adjourned meeting shall be given as in the case of an original meeting. Save as aforesaid it shall not be necessary to give any notice of an adjournment or of the business to be transacted at an adjourned meeting.
70. The Directors may cancel or postpone any duly convened general meeting at any time prior to such meeting, except for general meetings requisitioned by the Shareholders in accordance with these Articles, for any reason or for no reason, upon notice in writing to Shareholders. A postponement may be for a stated period of any length or indefinitely as the Directors may determine. Notice of the business to be transacted at such postponed general meeting shall not be required.
71. At any general meeting a resolution put to the vote of the meeting shall be decided by way of a poll save that the chairman of the meeting may, in good faith, allow a resolution which relates purely to a procedural or administrative matter to be voted on by a show of hands, and where a show of hands is allowed pursuant to these Articles, before or on the declaration of the result of the show of hands, a poll may be demanded by the chairman of the meeting or any Shareholder present in person or by proxy. Where a resolution is voted on by a show of hands, a declaration by the chairman of the meeting that a resolution has, on a show of hands, been carried, or carried unanimously, or by a particular majority, or lost, and an entry to that effect in the book of the proceedings of the Company, shall be conclusive evidence of the fact, without proof of the number or proportion of the votes recorded in favour of, or against, that resolution. For the purposes of these Articles, procedural and administrative matters are (i) the proposal of new resolutions which are not already set out in the notice convening the general meeting or any proposed amendments to the resolutions; and (ii) those that relate to the chairman's duties to maintain the orderly conduct of the meeting and/or allow the business of the meeting to be properly and effectively dealt with, whilst allowing all Shareholders a reasonable opportunity to express their views.
72. If a poll is duly demanded it shall be taken in such manner as the chairman of the meeting directs, and the result of the poll shall be deemed to be the resolution of the meeting at which the poll was demanded.
73. All questions submitted to a meeting shall be decided by an Ordinary Resolution except where a greater majority is required by these Articles or by the Companies Act. In the case of an equality of votes, whether on a show of hands or on a poll, the chairman of the meeting at which the show of hands takes place or at which the poll is demanded, shall be entitled to a second or casting vote.

74. A poll demanded on the election of a chairman of the meeting or on a question of adjournment shall be taken forthwith. A poll demanded on any other question shall be taken at such time as the chairman of the meeting directs.

#### VOTES OF SHAREHOLDERS

75. Subject to any rights and restrictions for the time being attached to any Share, at a general meeting of the Company, (i) on a show of hands, every Shareholder Present at the meeting shall have one vote, and (ii) on a poll, every Shareholder Present at the meeting shall have one (1) vote for each Ordinary Share of which such Shareholder is the holder.
76. In the case of joint holders the vote of the senior who tenders a vote whether in person or by proxy (or, if a corporation or other non-natural person, by its duly authorised representative or proxy) shall be accepted to the exclusion of the votes of the other joint holders and for this purpose seniority shall be determined by the order in which the names stand in the Register.
77. Shares carrying the right to vote that are held by a Shareholder of unsound mind, or in respect of whom an order has been made by any court having jurisdiction in lunacy, may be voted, whether on a show of hands or on a poll, by his committee, or other Person in the nature of a committee appointed by that court, and any such committee or other Person may vote in respect of such Shares by proxy.
78. No Shareholder shall be entitled to vote at any general meeting of the Company unless all calls, if any, or other sums presently payable by him in respect of Shares carrying the right to vote held by him have been paid.
79. On a poll votes may be given either personally or by proxy.
80. Each Shareholder, other than a recognised clearing house (or its nominee(s)) or depository (or its nominee(s)), may only appoint one proxy on a show of hand. The instrument appointing a proxy shall be in writing under the hand of the appointor or of his attorney duly authorised in writing or, if the appointor is a corporation, either under Seal or under the hand of an officer or attorney duly authorised. A proxy need not be a Shareholder.
81. An instrument appointing a proxy may be in any usual or common form or such other form as the Directors may approve.
82. The instrument appointing a proxy shall be deposited at the Registered Office or at such other place as is specified for that purpose in the notice convening the meeting, or in any instrument of proxy sent out by the Company:
- (a) not less than 48 hours before the time for holding the meeting or adjourned meeting at which the person named in the instrument proposes to vote; or
  - (b) in the case of a poll taken more than 48 hours after it is demanded, be deposited as aforesaid after the poll has been demanded and not less than 24 hours before the time appointed for the taking of the poll; or

- (c) where the poll is not taken forthwith but is taken not more than 48 hours after it was demanded be delivered at the meeting at which the poll was demanded to the chairman of the meeting or to the secretary or to any Director;

provided that the Directors may in the notice convening the meeting, or in an instrument of proxy sent out by the Company, direct that the instrument appointing a proxy may be deposited at such other time (no later than the time for holding the meeting or adjourned meeting) at the Registered Office or at such other place as is specified for that purpose in the notice convening the meeting, or in any instrument of proxy sent out by the Company. The chairman of the meeting may in any event at his discretion direct that an instrument of proxy shall be deemed to have been duly deposited. An instrument of proxy that is not deposited in the manner permitted shall be invalid.

83. The instrument appointing a proxy shall be deemed to confer authority to demand or join in demanding a poll.
84. A resolution in writing signed by all the Shareholders for the time being entitled to receive notice of and to attend and vote at general meetings of the Company (or being corporations by their duly authorised representatives) shall be as valid and effective as if the same had been passed at a general meeting of the Company duly convened and held.

#### **CORPORATIONS ACTING BY REPRESENTATIVES AT MEETINGS**

85. Any corporation which is a Shareholder or a Director may by resolution of its directors or other governing body authorise such Person as it thinks fit to act as its representative at any meeting of the Company or of any meeting of holders of a Class or of the Directors or of a committee of Directors, and the Person so authorised shall be entitled to exercise the same powers on behalf of the corporation which he represents as that corporation could exercise if it were an individual Shareholder or Director.

#### **DEPOSITARY AND CLEARING HOUSES**

86. If a recognised clearing house (or its nominee(s)) or depositary (or its nominee(s)) is a Member of the Company it may, by resolution of its directors or other governing body or by power of attorney, authorise such Person(s) as it thinks fit to act as its representative(s) at any general meeting of the Company or of any Class of Shareholders provided that, if more than one Person is so authorised, the authorisation shall specify the number and Class of Shares in respect of which each such Person is so authorised. A Person so authorised pursuant to this Article shall be entitled to exercise the same powers on behalf of the recognised clearing house (or its nominee(s)) or depositary (or its nominee(s)) which he represents as that recognised clearing house (or its nominee(s)) or depositary (or its nominee(s)) could exercise if it were an individual Member holding the number and Class of Shares specified in such authorisation, including the right to vote individually on a show of hands.

## DIRECTORS

87. Unless otherwise determined by the Company in general meeting, the number of Directors shall not be more than seven (7) Directors. The Board of Directors shall have the right to change the size of the Board of Directors and determine the exact number of Directors.
88. All Directors shall hold office until the expiration of their respective terms of office and until their successors shall have been appointed and qualified. A Director appointed to fill a vacancy resulting from the death, resignation or removal of a Director shall serve for the remainder of the full term of the Director whose death, resignation or removal shall have created such vacancy and until his successor shall have been appointed and qualified.
89. The Company may by Ordinary Resolution appoint any person to be a Director.
90. The Board may, by the affirmative vote of a simple majority of the remaining Directors present and voting at a Board meeting, appoint any person as a Director, to fill a casual vacancy on the Board or as an addition to the existing Board.
91. A Director may be removed from office by Ordinary Resolution, notwithstanding anything in these Articles or in any agreement between the Company and such Director (but without prejudice to any claim for damages under such agreement). A vacancy on the Board created by the removal of a Director under the previous sentence may be filled by Ordinary Resolution or by the affirmative vote of a simple majority of the remaining Directors present and voting at a Board meeting. The notice of any meeting at which a resolution to remove a Director shall be proposed or voted upon must contain a statement of the intention to remove that Director and such notice must be served on that Director not less than ten (10) calendar days before the meeting. Such Director is entitled to attend the meeting and be heard on the motion for his removal.
92. The Board of Directors shall elect and appoint a Chairman by a majority of the Directors then in office. The period for which the Chairman will hold office will also be determined by a majority of all of the Directors then in office. The Chairman shall preside as chairman at every meeting of the Board of Directors. To the extent the Chairman is not present at a meeting of the Board of Directors within fifteen minutes after the time appointed for holding the same, the attending Directors may choose one of their number to be the chairman of the meeting.
93. The Board may, from time to time, and except as required by applicable law or Designated Stock Exchange Rules, adopt, institute, amend, modify or revoke the corporate governance policies or initiatives of the Company and determine on various corporate governance related matters of the Company as the Board shall determine by resolution of Directors from time to time.
94. A Director shall not be required to hold any Shares in the Company by way of qualification. A Director who is not a Member of the Company shall nevertheless be entitled to attend and speak at general meetings.
95. The remuneration of the Directors may be determined by the Directors or by Ordinary Resolution.

96. The Directors shall be entitled to be paid their travelling, hotel and other expenses properly incurred by them in going to, attending and returning from meetings of the Directors, or any committee of the Directors, or general meetings of the Company, or otherwise in connection with the business of the Company, or to receive such fixed allowance in respect thereof as may be determined by the Directors from time to time, or a combination partly of one such method and partly the other.

#### **ALTERNATE DIRECTOR OR PROXY**

97. Any Director may in writing appoint another Person to be his alternate and, save to the extent provided otherwise in the form of appointment, such alternate shall have authority to sign written resolutions on behalf of the appointing Director, but shall not be required to sign such written resolutions where they have been signed by the appointing director, and to act in such Director's place at any meeting of the Directors at which the appointing Director is unable to be present. Every such alternate shall be entitled to attend and vote at meetings of the Directors as a Director when the Director appointing him is not personally present and where he is a Director to have a separate vote on behalf of the Director he is representing in addition to his own vote. A Director may at any time in writing revoke the appointment of an alternate appointed by him. Such alternate shall be deemed for all purposes to be a Director and shall not be deemed to be the agent of the Director appointing him. The remuneration of such alternate shall be payable out of the remuneration of the Director appointing him and the proportion thereof shall be agreed between them.
98. Any Director may appoint any Person, whether or not a Director, to be the proxy of that Director to attend and vote on his behalf, in accordance with instructions given by that Director, or in the absence of such instructions at the discretion of the proxy, at a meeting or meetings of the Directors which that Director is unable to attend personally. The instrument appointing the proxy shall be in writing under the hand of the appointing Director and shall be in any usual or common form or such other form as the Directors may approve, and must be lodged with the chairman of the meeting of the Directors at which such proxy is to be used, or first used, prior to the commencement of the meeting.

#### **POWERS AND DUTIES OF DIRECTORS**

99. Subject to the Companies Act, these Articles and to any resolutions passed in a general meeting, the business of the Company shall be managed by the Directors, who may pay all expenses incurred in setting up and registering the Company and may exercise all powers of the Company. No resolution passed by the Company in general meeting shall invalidate any prior act of the Directors that would have been valid if that resolution had not been passed.
100. Subject to these Articles, the Directors may from time to time appoint any natural person or corporation, whether or not a Director to hold such office in the Company as the Directors may think necessary for the administration of the Company, including but not limited to, chief executive officer, one or more other executive officers, president, one or more vice presidents, treasurer, assistant treasurer, manager or controller, and for such term and at such remuneration (whether by way of salary or commission or participation in profits or partly in one way and partly in another), and with such powers and duties as the Directors may think fit. Any natural person or corporation so appointed by the Directors may be removed by the Directors. The Directors may also appoint one or more of their number to the office of managing director upon like terms, but any such appointment shall ipso facto terminate if any managing director ceases for any cause to be a Director, or if the Company by Ordinary Resolution resolves that his tenure of office be terminated.

101. The Directors may appoint any natural person or corporation to be a Secretary (and if need be an assistant Secretary or assistant Secretaries) who shall hold office for such term, at such remuneration and upon such conditions and with such powers as they think fit. Any Secretary or assistant Secretary so appointed by the Directors may be removed by the Directors or by the Company by Ordinary Resolution.
102. The Directors may delegate any of their powers to committees consisting of such member or members of their body as they think fit; any committee so formed shall in the exercise of the powers so delegated conform to any regulations that may be imposed on it by the Directors.
103. The Directors may from time to time and at any time by power of attorney (whether under Seal or under hand) or otherwise appoint any company, firm or Person or body of Persons, whether nominated directly or indirectly by the Directors, to be the attorney or attorneys or authorised signatory (any such person being an "Attorney" or "Authorised Signatory", respectively) of the Company for such purposes and with such powers, authorities and discretion (not exceeding those vested in or exercisable by the Directors under these Articles) and for such period and subject to such conditions as they may think fit, and any such power of attorney or other appointment may contain such provisions for the protection and convenience of Persons dealing with any such Attorney or Authorised Signatory as the Directors may think fit, and may also authorise any such Attorney or Authorised Signatory to delegate all or any of the powers, authorities and discretion vested in him.
104. The Directors may from time to time provide for the management of the affairs of the Company in such manner as they shall think fit and the provisions contained in the three next following Articles shall not limit the general powers conferred by this Article.
105. The Directors from time to time and at any time may establish any committees, local boards or agencies for managing any of the affairs of the Company and may appoint any natural person or corporation to be a member of such committees or local boards and may appoint any managers or agents of the Company and may fix the remuneration of any such natural person or corporation.
106. The Directors from time to time and at any time may delegate to any such committee, local board, manager or agent any of the powers, authorities and discretions for the time being vested in the Directors and may authorise the members for the time being of any such local board, or any of them to fill any vacancies therein and to act notwithstanding vacancies and any such appointment or delegation may be made on such terms and subject to such conditions as the Directors may think fit and the Directors may at any time remove any natural person or corporation so appointed and may annul or vary any such delegation, but no Person dealing in good faith and without notice of any such annulment or variation shall be affected thereby.
107. Any such delegates as aforesaid may be authorised by the Directors to sub-delegate all or any of the powers, authorities, and discretion for the time being vested in them.

### **BORROWING POWERS OF DIRECTORS**

108. The Directors may from time to time at their discretion exercise all the powers of the Company to raise or borrow money and to mortgage or charge its undertaking, property and assets (present and future) and uncalled capital or any part thereof, to issue debentures, debenture stock, bonds and other securities, whether outright or as collateral security for any debt, liability or obligation of the Company or of any third party.

### **THE SEAL**

109. The Seal shall not be affixed to any instrument except by the authority of a resolution of the Directors provided always that such authority may be given prior to or after the affixing of the Seal and if given after may be in general form confirming a number of affixing of the Seal. The Seal shall be affixed in the presence of a Director or a Secretary (or an assistant Secretary) or in the presence of any one or more Persons as the Directors may appoint for the purpose and every Person as aforesaid shall sign every instrument to which the Seal is so affixed in their presence.
110. The Company may maintain a facsimile of the Seal in such countries or places as the Directors may appoint and such facsimile Seal shall not be affixed to any instrument except by the authority of a resolution of the Directors provided always that such authority may be given prior to or after the affixing of such facsimile Seal and if given after may be in general form confirming a number of affixing of such facsimile Seal. The facsimile Seal shall be affixed in the presence of such Person or Persons as the Directors shall for this purpose appoint and such Person or Persons as aforesaid shall sign every instrument to which the facsimile Seal is so affixed in their presence and such affixing of the facsimile Seal and signing as aforesaid shall have the same meaning and effect as if the Seal had been affixed in the presence of and the instrument signed by a Director or a Secretary (or an assistant Secretary) or in the presence of any one or more Persons as the Directors may appoint for the purpose.
111. Notwithstanding the foregoing, a Secretary or any assistant Secretary shall have the authority to affix the Seal, or the facsimile Seal, to any instrument for the purposes of attesting authenticity of the matter contained therein but which does not create any obligation binding on the Company.

### **DISQUALIFICATION OF DIRECTORS**

112. The office of Director shall be vacated, if the Director:
- (a) becomes bankrupt or makes any arrangement or composition with his creditors;
  - (b) dies or is found to be or becomes of unsound mind;
  - (c) resigns his office by notice in writing to the Company;
  - (d) is prohibited by any applicable Law or Designated Stock Exchange Rules from being a Director;



- (e) without special leave of absence from the Board, is absent from meetings of the Board for three consecutive meetings and the Board resolves that his office be vacated; or
- (f) is removed from office pursuant to any other provision of these Articles.

#### **PROCEEDINGS OF DIRECTORS**

- 113. The Directors may meet together (either within or outside of the Cayman Islands) for the despatch of business, adjourn, and otherwise regulate their meetings and proceedings as they think fit. Questions arising at any meeting shall be decided by a majority of votes. At any meeting of the Directors, each Director present in person or represented by his proxy or alternate shall be entitled to one vote. In case of an equality of votes the Chairman shall have a second or casting vote. A Director may, and a Secretary or assistant Secretary on the requisition of a Director shall, at any time summon a meeting of the Directors.
- 114. A Director may participate in any meeting of the Directors, or of any committee appointed by the Directors of which such Director is a member, by means of telephone or similar communication equipment by way of which all Persons participating in such meeting can communicate with each other and such participation shall be deemed to constitute presence in person at the meeting.
- 115. The quorum necessary for the transaction of the business of the Board may be fixed by the Directors, and unless so fixed, the quorum shall be a majority of Directors then in office. A Director represented by proxy or by an alternate Director at any meeting shall be deemed to be present for the purposes of determining whether or not a quorum is present.
- 116. A Director who is in any way, whether directly or indirectly, interested in a contract or transaction or proposed contract or transaction with the Company shall declare the nature of his interest at a meeting of the Directors. A general notice given to the Directors by any Director to the effect that he is a member of any specified company or firm and is to be regarded as interested in any contract or transaction which may thereafter be made with that company or firm shall be deemed a sufficient declaration of interest in regard to any contract so made or transaction so consummated. Subject to the Designated Stock Exchange Rules and disqualification by the chairman of the relevant Board meeting, a Director may vote in respect of any contract or transaction or proposed contract or transaction notwithstanding that he may be interested therein and if he does so his vote shall be counted and he may be counted in the quorum at any meeting of the Directors at which any such contract or transaction or proposed contract or transaction shall come before the meeting for consideration, provided that:
  - (a) such Director, if his interest (whether direct or indirect) in such contract or arrangement is material, has declared the nature of his interest at the earliest meeting of the Board at which it is practicable for him to do so, either specifically or by way of a general notice; and
  - (b) if such contract or arrangement is a transaction with a related party, such transaction has been approved by the audit committee of the Company.

117. A Director may hold any other office or place of profit under the Company (other than the office of auditor) in conjunction with his office of Director for such period and on such terms (as to remuneration and otherwise) as the Directors may determine and no Director or intending Director shall be disqualified by his office from contracting with the Company either with regard to his tenure of any such other office or place of profit or as vendor, purchaser or otherwise, nor shall any such contract or arrangement entered into by or on behalf of the Company in which any Director is in any way interested be liable to be avoided, nor shall any Director so contracting or being so interested be liable to account to the Company for any profit realised by any such contract or arrangement by reason of such Director holding that office or of the fiduciary relation thereby established. A Director, notwithstanding his interest, may be counted in the quorum present at any meeting of the Directors whereat he or any other Director is appointed to hold any such office or place of profit under the Company or whereat the terms of any such appointment are arranged and he may vote on any such appointment or arrangement.
118. Any Director may act by himself or through his firm in a professional capacity for the Company, and he or his firm shall be entitled to remuneration for professional services as if he were not a Director; provided that nothing herein contained shall authorise a Director or his firm to act as auditor to the Company.
119. The Directors shall cause minutes to be made for the purpose of recording:
- (a) all appointments of officers made by the Directors;
  - (b) the names of the Directors present at each meeting of the Directors and of any committee of the Directors; and
  - (c) all resolutions and proceedings at all meetings of the Company, and of the Directors and of committees of Directors.
120. When the chairman of a meeting of the Directors signs the minutes of such meeting the same shall be deemed to have been duly held notwithstanding that all the Directors have not actually come together or that there may have been a technical defect in the proceedings.
121. A resolution in writing signed by all the Directors or all the members of a committee of Directors entitled to receive notice of a meeting of Directors or committee of Directors, as the case may be (an alternate Director, subject as provided otherwise in the terms of appointment of the alternate Director, being entitled to sign such a resolution on behalf of his appointer), shall be as valid and effectual as if it had been passed at a duly called and constituted meeting of Directors or committee of Directors, as the case may be. When signed a resolution may consist of several documents each signed by one or more of the Directors or his duly appointed alternate.
122. Meetings of the Directors may be called by any Director on not less than 48 hours' notice to each Director in accordance with Articles 149 through 154; provided that a meeting of the Directors shall, whether or not the notice specified in this Article has been given and whether or not the provisions of these Articles regarding meetings of the Directors have been complied with, be deemed to have been duly convened if it is so agreed by a majority of the Directors then in office.

123. The continuing Directors may act notwithstanding any vacancy in their body but if and for so long as their number is reduced below the number fixed by or pursuant to these Articles as the necessary quorum of Directors, the continuing Directors may act for the purpose of increasing the number, or of summoning a general meeting of the Company, but for no other purpose.
124. Subject to any regulations imposed on it by the Directors, a committee appointed by the Directors may elect a chairman of its meetings. If no such chairman is elected, or if at any meeting the chairman is not present within fifteen minutes after the time appointed for holding the meeting, the committee members present may choose one of their number to be chairman of the meeting.
125. A committee appointed by the Directors may meet and adjourn as it thinks proper. Subject to any regulations imposed on it by the Directors, questions arising at any meeting shall be determined by a majority of votes of the committee members present and in case of an equality of votes the chairman shall have a second or casting vote.
126. All acts done by any meeting of the Directors or of a committee of Directors, or by any Person acting as a Director, shall notwithstanding that it be afterwards discovered that there was some defect in the appointment of any such Director or Person acting as aforesaid, or that they or any of them were disqualified, be as valid as if every such Person had been duly appointed and was qualified to be a Director.

#### **PRESUMPTION OF ASSENT**

127. A Director who is present at a meeting of the Board of Directors at which an action on any Company matter is taken shall be presumed to have assented to the action taken unless his dissent shall be entered in the minutes of the meeting or unless he shall file his written dissent from such action with the person acting as the chairman or secretary of the meeting before the adjournment thereof or shall forward such dissent by registered post to such person immediately after the adjournment of the meeting. Such right to dissent shall not apply to a Director who voted in favour of such action.

#### **DIVIDENDS**

128. Subject to any rights and restrictions for the time being attached to any Shares, the Directors may from time to time declare dividends (including interim dividends) and other distributions on Shares in issue and authorise payment of the same out of the funds of the Company lawfully available therefor.
129. Subject to any rights and restrictions for the time being attached to any Shares, the Company by Ordinary Resolution may declare dividends, but no dividend shall exceed the amount recommended by the Directors.
130. The Directors may, before recommending or declaring any dividend, set aside out of the funds legally available for distribution such sums as they think proper as a reserve or reserves which shall, in the absolute discretion of the Directors, be applicable for meeting contingencies or for equalising dividends or for any other purpose to which those funds may be properly applied, and pending such application may in the absolute discretion of the Directors, either be employed in the business of the Company or be invested in such investments (other than Shares of the Company) as the Directors may from time to time think fit.

131. Any dividend payable in cash to the holder of Shares may be paid in any manner determined by the Directors. If paid by cheque it will be sent by mail addressed to the holder at his address in the Register, or addressed to such person and at such addresses as the holder may direct. Every such cheque or warrant shall, unless the holder or joint holders otherwise direct, be made payable to the order of the holder or, in the case of joint holders, to the order of the holder whose name stands first on the Register in respect of such Shares, and shall be sent at his or their risk and payment of the cheque or warrant by the bank on which it is drawn shall constitute a good discharge to the Company.
132. The Directors may determine that a dividend shall be paid wholly or partly by the distribution of specific assets (which may consist of the shares or securities of any other company) and may settle all questions concerning such distribution. Without limiting the generality of the foregoing, the Directors may fix the value of such specific assets, may determine that cash payment shall be made to some Shareholders in lieu of specific assets and may vest any such specific assets in trustees on such terms as the Directors think fit.
133. Subject to any rights and restrictions for the time being attached to any Shares, all dividends shall be declared and paid according to the amounts paid up on the Shares, but if and for so long as nothing is paid up on any of the Shares dividends may be declared and paid according to the par value of the Shares. No amount paid on a Share in advance of calls shall, while carrying interest, be treated for the purposes of this Article as paid on the Share.
134. If several Persons are registered as joint holders of any Share, any of them may give effective receipts for any dividend or other moneys payable on or in respect of the Share.
135. No dividend shall bear interest against the Company.
136. Any dividend unclaimed after a period of six calendar years from the date of declaration of such dividend may be forfeited by the Board of Directors and, if so forfeited, shall revert to the Company.

#### **ACCOUNTS, AUDIT AND ANNUAL RETURN AND DECLARATION**

137. The books of account relating to the Company's affairs shall be kept in such manner as may be determined from time to time by the Directors.
138. The books of account shall be kept at the Registered Office, or at such other place or places as the Directors think fit, and shall always be open to the inspection of the Directors.
139. The Directors may from time to time determine whether and to what extent and at what times and places and under what conditions or regulations the accounts and books of the Company or any of them shall be open to the inspection of Shareholders not being Directors, and no Shareholder (not being a Director) shall have any right to inspect any account or book or document of the Company except as conferred by law or authorised by the Directors or by Ordinary Resolution.

140. The accounts relating to the Company's affairs shall be audited in such manner and with such financial year end as may be determined from time to time by the Directors or failing any determination as aforesaid shall not be audited.
141. The Directors may appoint an auditor of the Company who shall hold office until removed from office by a resolution of the Directors and may fix his or their remuneration.
142. Every auditor of the Company shall have a right of access at all times to the books and accounts and vouchers of the Company and shall be entitled to require from the Directors and officers of the Company such information and explanation as may be necessary for the performance of the duties of the auditors.
143. The auditors shall, if so required by the Directors, make a report on the accounts of the Company during their tenure of office at the next annual general meeting following their appointment, and at any time during their term of office, upon request of the Directors or any general meeting of the Members.
144. The Directors in each calendar year shall prepare, or cause to be prepared, an annual return and declaration setting forth the particulars required by the Companies Act and deliver a copy thereof to the Registrar of Companies in the Cayman Islands.

#### **CAPITALISATION OF RESERVES**

145. Subject to the Companies Act and these Articles, the Directors may:
- (a) resolve to capitalise an amount standing to the credit of reserves (including a Share Premium Account, capital redemption reserve and profit and loss account), which is available for distribution;
  - (b) appropriate the sum resolved to be capitalised to the Shareholders in proportion to the nominal amount of Shares (whether or not fully paid) held by them respectively and apply that sum on their behalf in or towards:
    - (i) paying up the amounts (if any) for the time being unpaid on Shares held by them respectively, or
    - (ii) paying up in full unissued Shares or debentures of a nominal amount equal to that sum,
- and allot the Shares or debentures, credited as fully paid, to the Shareholders (or as they may direct) in those proportions, or partly in one way and partly in the other, but the Share Premium Account, the capital redemption reserve and profits which are not available for distribution may, for the purposes of this Article, only be applied in paying up unissued Shares to be allotted to Shareholders credited as fully paid;
- (c) make any arrangements they think fit to resolve a difficulty arising in the distribution of a capitalised reserve and in particular, without limitation, where Shares or debentures become distributable in fractions the Directors may deal with the fractions as they think fit;

- (d) authorise a Person to enter (on behalf of all the Shareholders concerned) into an agreement with the Company providing for either:
  - (i) the allotment to the Shareholders respectively, credited as fully paid, of Shares or debentures to which they may be entitled on the capitalisation, or
  - (ii) the payment by the Company on behalf of the Shareholders (by the application of their respective proportions of the reserves resolved to be capitalised) of the amounts or part of the amounts remaining unpaid on their existing Shares,

and any such agreement made under this authority being effective and binding on all those Shareholders; and

- (e) generally do all acts and things required to give effect to the resolution.

146. Notwithstanding any provisions in these Articles, the Directors may resolve to capitalise an amount standing to the credit of reserves (including the share premium account, capital redemption reserve and profit and loss account) or otherwise available for distribution by applying such sum in paying up in full unissued Shares to be allotted and issued to:

- (a) employees (including Directors) or service providers of the Company or its subsidiaries or group companies upon exercise or vesting of any options or awards granted under any share incentive scheme or employee benefit scheme or other arrangement which relates to such persons that has been adopted or approved by the Directors or the Members;
- (b) any trustee of any trust or administrator of any share incentive scheme or employee benefit scheme to whom shares are to be allotted and issued by the Company in connection with the operation of any share incentive scheme or employee benefit scheme or other arrangement which relates to such persons that has been adopted or approved by the Directors or Members; or
- (c) any depository of the Company for the purposes of the issue, allotment and delivery by the depository of ADSs to employees (including Directors) or service providers of the Company or its subsidiaries or group companies upon exercise or vesting of any options or awards granted under any share incentive scheme or employee benefit scheme or other arrangement which relates to such persons that has been adopted or approved by the Directors or the Members.

#### **SHARE PREMIUM ACCOUNT**

147. The Directors shall in accordance with the Companies Act establish a Share Premium Account and shall carry to the credit of such account from time to time a sum equal to the amount or value of the premium paid on the issue of any Share.

148. There shall be debited to any Share Premium Account on the redemption or purchase of a Share the difference between the nominal value of such Share and the redemption or purchase price provided always that at the discretion of the Directors such sum may be paid out of the profits of the Company or, if permitted by the Companies Act, out of capital.

#### NOTICES

149. Except as otherwise provided in these Articles, any notice or document may be served by the Company or by the Person entitled to give notice to any Shareholder either personally, or by posting it by airmail or a recognised courier service in a prepaid letter addressed to such Shareholder at his address as appearing in the Register, or by electronic mail to any electronic mail address such Shareholder may have specified in writing for the purpose of such service of notices, or by facsimile to any facsimile number such Shareholder may have specified in writing for the purpose of such service of notices, or by placing it on the Company's Website should the Directors deem it appropriate. In the case of joint holders of a Share, all notices shall be given to that one of the joint holders whose name stands first in the Register in respect of the joint holding, and notice so given shall be sufficient notice to all the joint holders.
150. Notices sent from one country to another shall be sent or forwarded by prepaid airmail or a recognised courier service.
151. Any Shareholder Present at any meeting of the Company shall for all purposes be deemed to have received due notice of such meeting and, where requisite, of the purposes for which such meeting was convened.
152. Any notice or other document, if served by:
- (a) post, shall be deemed to have been served five calendar days after the time when the letter containing the same is posted;
  - (b) facsimile, shall be deemed to have been served upon production by the transmitting facsimile machine of a report confirming transmission of the facsimile in full to the facsimile number of the recipient;
  - (c) recognised courier service, shall be deemed to have been served 48 hours after the time when the letter containing the same is delivered to the courier service; or
  - (d) electronic means, shall be deemed to have been served immediately (i) upon the time of the transmission to the electronic mail address supplied by the Shareholder to the Company or (ii) upon the time of its placement on the Company's Website.
- In proving service by post or courier service it shall be sufficient to prove that the letter containing the notice or documents was properly addressed and duly posted or delivered to the courier service.
153. Any notice or document delivered or sent by post to or left at the registered address of any Shareholder in accordance with the terms of these Articles shall notwithstanding that such Shareholder be then dead or bankrupt, and whether or not the Company has notice of his death or bankruptcy, be deemed to have been duly served in respect of any Share registered in the name of such Shareholder as sole or joint holder, unless his name shall at the time of the service of the notice or document have been removed from the Register as the holder of the Share, and such service shall for all purposes be deemed a sufficient service of such notice or document on all Persons interested (whether jointly with or as claiming through or under him) in the Share.

154. Notice of every general meeting of the Company shall be given to:
- (a) all Shareholders holding Shares with the right to receive notice and who have supplied to the Company an address for the giving of notices to them; and
  - (b) every Person entitled to a Share in consequence of the death or bankruptcy of a Shareholder, who but for his death or bankruptcy would be entitled to receive notice of the meeting.

No other Person shall be entitled to receive notices of general meetings.

#### **INFORMATION**

155. Subject to the relevant laws, rules and regulations applicable to the Company, no Member shall be entitled to require discovery of any information in respect of any detail of the Company's trading or any information which is or may be in the nature of a trade secret or secret process which may relate to the conduct of the business of the Company and which in the opinion of the Board would not be in the interests of the Members of the Company to communicate to the public.
156. Subject to due compliance with the relevant laws, rules and regulations applicable to the Company, the Board shall be entitled to release or disclose any information in its possession, custody or control regarding the Company or its affairs to any of its Members including, without limitation, information contained in the Register and transfer books of the Company.

#### **INDEMNITY**

157. Every Director (including for the purposes of this Article any alternate Director appointed pursuant to the provisions of these Articles), Secretary, assistant Secretary, or other officer for the time being and from time to time of the Company (but not including the Company's auditors) and the personal representatives of the same (each an "Indemnified Person") shall be indemnified and secured harmless against all actions, proceedings, costs, charges, expenses, losses, damages or liabilities incurred or sustained by such Indemnified Person, other than by reason of such Indemnified Person's own dishonesty, wilful default or fraud, in or about the conduct of the Company's business or affairs (including as a result of any mistake of judgment) or in the execution or discharge of his duties, powers, authorities or discretions, including without prejudice to the generality of the foregoing, any costs, expenses, losses or liabilities incurred by such Indemnified Person in defending (whether successfully or otherwise) any civil proceedings concerning the Company or its affairs in any court whether in the Cayman Islands or elsewhere.



158. No Indemnified Person shall be liable:
- (a) for the acts, receipts, neglects, defaults or omissions of any other Director or officer or agent of the Company; or
  - (b) for any loss on account of defect of title to any property of the Company; or
  - (c) on account of the insufficiency of any security in or upon which any money of the Company shall be invested; or
  - (d) for any loss incurred through any bank, broker or other similar Person; or
  - (e) for any loss occasioned by any negligence, default, breach of duty, breach of trust, error of judgement or oversight on such Indemnified Person's part; or
  - (f) for any loss, damage or misfortune whatsoever which may happen in or arise from the execution or discharge of the duties, powers, authorities, or discretions of such Indemnified Person's office or in relation thereto;
- unless the same shall happen through such Indemnified Person's own dishonesty, willful default or fraud.

#### **FINANCIAL YEAR**

159. Unless the Directors otherwise prescribe, the financial year of the Company shall end on December 31<sup>st</sup> in each calendar year and shall begin on January 1st in each calendar year.

#### **NON-RECOGNITION OF TRUSTS**

160. No Person shall be recognised by the Company as holding any Share upon any trust and the Company shall not, unless required by law, be bound by or be compelled in any way to recognise (even when having notice thereof) any equitable, contingent, future or partial interest in any Share or (except only as otherwise provided by these Articles or as the Companies Act requires) any other right in respect of any Share except an absolute right to the entirety thereof in each Shareholder registered in the Register.

#### **WINDING UP**

161. If the Company shall be wound up the liquidator may, with the sanction of a Special Resolution of the Company and any other sanction required by the Companies Act, divide amongst the Members in specie or in kind the whole or any part of the assets of the Company (whether they shall consist of property of the same kind or not) and may for that purpose value any assets and determine how the division shall be carried out as between the Members or different classes of Members. The liquidator may, with the like sanction, vest the whole or any part of such assets in trustees upon such trusts for the benefit of the Members as the liquidator, with the like sanction, shall think fit, but so that no Member shall be compelled to accept any asset upon which there is a liability.

162. If the Company shall be wound up, and the assets available for distribution amongst the Members shall be insufficient to repay the whole of the share capital, such assets shall be distributed so that, as nearly as may be, the losses shall be borne by the Members in proportion to the par value of the Shares held by them. If in a winding up the assets available for distribution amongst the Members shall be more than sufficient to repay the whole of the share capital at the commencement of the winding up, the surplus shall be distributed amongst the Members in proportion to the par value of the Shares held by them at the commencement of the winding up subject to a deduction from those Shares in respect of which there are monies due, of all monies payable to the Company for unpaid calls or otherwise. This Article is without prejudice to the rights of the holders of Shares issued upon special terms and conditions.

#### **AMENDMENT OF ARTICLES OF ASSOCIATION**

163. Subject to the Companies Act, the Company may at any time and from time to time by Special Resolution alter or amend these Articles in whole or in part.

#### **CLOSING OF REGISTER OR FIXING RECORD DATE**

164. For the purpose of determining those Shareholders that are entitled to receive notice of, attend or vote at any meeting of Shareholders or any adjournment thereof, or those Shareholders that are entitled to receive payment of any dividend, or in order to make a determination as to who is a Shareholder for any other purpose, the Directors may provide that the Register shall be closed for transfers for a stated period which shall not exceed in any case thirty calendar days in any calendar year.
165. In lieu of or apart from closing the Register, the Directors may fix in advance a date as the record date for any such determination of those Shareholders that are entitled to receive notice of, attend or vote at a meeting of the Shareholders and for the purpose of determining those Shareholders that are entitled to receive payment of any dividend the Directors may, at or within ninety calendar days prior to the date of declaration of such dividend, fix a subsequent date as the record date for such determination.
166. If the Register is not so closed and no record date is fixed for the determination of those Shareholders entitled to receive notice of, attend or vote at a meeting of Shareholders or those Shareholders that are entitled to receive payment of a dividend, the date on which notice of the meeting is posted or the date on which the resolution of the Directors declaring such dividend is adopted, as the case may be, shall be the record date for such determination of Shareholders. When a determination of those Shareholders that are entitled to receive notice of, attend or vote at a meeting of Shareholders has been made as provided in this Article, such determination shall apply to any adjournment thereof.

#### **REGISTRATION BY WAY OF CONTINUATION**

167. The Company may by Special Resolution resolve to be registered by way of continuation in a jurisdiction outside the Cayman Islands or such other jurisdiction in which it is for the time being incorporated, registered or existing. In furtherance of a resolution adopted pursuant to this Article, the Directors may cause an application to be made to the Registrar of Companies to deregister the Company in the Cayman Islands or such other jurisdiction in which it is for the time being incorporated, registered or existing and may cause all such further steps as they consider appropriate to be taken to effect the transfer by way of continuation of the Company.

**DISCLOSURE**

168. The Directors, or any service providers (including the officers, the Secretary and the registered office provider of the Company) specifically authorised by the Directors, shall be entitled to disclose to any regulatory or judicial authority any information regarding the affairs of the Company including without limitation information contained in the Register and books of the Company.

BELITE BIO, INC

Number

Ordinary Shares

Incorporated under the laws of the Cayman Islands

Share capital is US\$50,000 divided into 500,000,000 shares of a par value of US\$0.0001 each, comprising of (i) [ ] Ordinary Shares of a par value of US\$0.0001 each, and

(ii) [ ] shares of a par value of US\$0.0001 each, of such class or classes (however designated) as the board of directors may determine in accordance with Articles 8 and 9 of the Articles of Association of the Company

THIS IS TO CERTIFY THAT \_\_\_\_\_ is the registered holder of \_\_\_\_\_ Ordinary Shares in the above-named Company subject to the Memorandum and Articles of Association thereof.

EXECUTED on behalf of the said Company on the \_\_\_\_\_ day of \_\_\_\_\_ by:

DIRECTOR \_\_\_\_\_

\_\_\_\_\_

---

**DEPOSIT AGREEMENT**

---

by and among

**BELITE BIO, INC**

as Issuer,

**DEUTSCHE BANK TRUST COMPANY AMERICAS**

as Depositary,

AND

**THE HOLDERS AND BENEFICIAL OWNERS  
OF AMERICAN DEPOSITARY SHARES EVIDENCED BY  
AMERICAN DEPOSITARY RECEIPTS ISSUED HEREUNDER**

---

**Dated as of [●], 2022**

---

---

## DEPOSIT AGREEMENT

**DEPOSIT AGREEMENT**, dated as of [●], 2022, by and among (i) Belite Bio, Inc, a company incorporated in the Cayman Islands, with its principal executive office at 5820 Oberlin Drive, Suite 101, San Diego, CA 92121, United States of America and its registered office at Maples Corporate Services Limited, PO Box 309, Ugland House, Grand Cayman, KY1-1104, Cayman Islands (together with its successors, the “**Company**”), (ii) Deutsche Bank Trust Company Americas, an indirect wholly owned subsidiary of Deutsche Bank A.G., acting in its capacity as depositary, with its principal office at 1 Columbus Circle, New York, NY 10019, United States of America (the “**Depositary**”, which term shall include any successor depositary hereunder) and (iii) all Holders and Beneficial Owners of American Depositary Shares evidenced by American Depositary Receipts issued hereunder (all such capitalized terms as hereinafter defined).

### WITNESSETH THAT:

**WHEREAS**, the Company desires to establish an ADR facility with the Depositary to provide for the deposit of the Shares and the creation of American Depositary Shares representing the Shares so deposited;

**WHEREAS**, the Depositary is willing to act as the depositary for such ADR facility upon the terms set forth in this Deposit Agreement;

**WHEREAS**, the American Depositary Receipts evidencing the American Depositary Shares issued pursuant to the terms of this Deposit Agreement are to be substantially in the form of Exhibit A and Exhibit B annexed hereto, with appropriate insertions, modifications and omissions, as hereinafter provided in this Deposit Agreement;

**WHEREAS**, the American Depositary Shares to be issued pursuant to the terms of this Deposit Agreement are accepted for trading on the New York Stock Exchange; and

**WHEREAS**, the Board of Directors of the Company (or an authorized committee thereof) has duly approved the establishment of an ADR facility upon the terms set forth in this Deposit Agreement, the execution and delivery of this Deposit Agreement on behalf of the Company, and the actions of the Company and the transactions contemplated herein.

**NOW, THEREFORE**, for good and valuable consideration, the receipt and sufficiency of which are hereby acknowledged, the parties hereto agree as follows:

### ARTICLE I.ARTICLEI.

#### DEFINITIONS

All capitalized terms used, but not otherwise defined, herein shall have the meanings set forth below, unless otherwise clearly indicated:

SECTION 1.1 “Affiliate” shall have the meaning assigned to such term by the Commission under Regulation C promulgated under the Securities Act.

SECTION 1.2 “Agent” shall mean such entity or entities as the Depositary may appoint under Section 7.8 hereof, including the Custodian or any successor or addition thereto.

SECTION 1.3 “American Depositary Share(s)” and “ADS(s)” shall mean the securities represented by the rights and interests in the Deposited Securities granted to the Holders and Beneficial Owners pursuant to this Deposit Agreement and evidenced by the American Depositary Receipts issued hereunder. Each American Depositary Share shall represent the right to receive [●] Share[s], until there shall occur a distribution upon Deposited Securities referred to in Section 4.2 hereof or a change in Deposited Securities referred to in Section 4.9 hereof with respect to which additional American Depositary Receipts are not executed and delivered and thereafter each American Depositary Share shall represent the Shares or Deposited Securities specified in such Sections.

SECTION 1.4 “Article” shall refer to an article of the American Depositary Receipts as set forth in the Form of Face of Receipt and Form of Reverse of Receipt in Exhibit A and Exhibit B annexed hereto.

SECTION 1.5 “Articles of Association” shall mean the articles of association of the Company, as amended from time to time.

SECTION 1.6 “ADS Record Date” shall have the meaning given to such term in Section 4.7 hereof.

SECTION 1.7 “Beneficial Owner” shall mean as to any ADS, any person or entity having a beneficial interest in such ADS. A Beneficial Owner need not be the Holder of the ADR evidencing such ADSs. A Beneficial Owner may exercise any rights or receive any benefits hereunder solely through the Holder of the ADR(s) evidencing the ADSs in which such Beneficial Owner has an interest.

SECTION 1.8 “Business Day” shall mean each Monday, Tuesday, Wednesday, Thursday and Friday which is not (a) a day on which banking institutions in the Borough of Manhattan, The City of New York are authorized or obligated by law or executive order to close and (b) a day on which the market(s) in which ADSs are traded are closed.

SECTION 1.9 “Commission” shall mean the Securities and Exchange Commission of the United States or any successor governmental agency in the United States.

SECTION 1.10 “Company” shall mean Belite Bio, Inc, a company incorporated and existing under the laws of the Cayman Islands, and its successors.

SECTION 1.11 “Corporate Trust Office” when used with respect to the Depository, shall mean the corporate trust office of the Depository at which at any particular time its depository receipts business shall be administered, which, at the date of this Deposit Agreement, is located at 1 Columbus Circle, New York, New York 10019, U.S.A.

SECTION 1.12 “Custodian” shall mean, as of the date hereof, Deutsche Bank AG, Hong Kong Branch, having its principal office at 57/F International Commerce Centre, 1 Austin Road West, Kowloon, Hong Kong S.A.R., People’s Republic of China, as the custodian for the purposes of this Deposit Agreement, and any other firm or corporation which may hereinafter be appointed by the Depository pursuant to the terms of Section 5.5 hereof as a successor or an additional custodian or custodians hereunder, as the context shall require. The term “Custodian” shall mean all custodians, collectively.

SECTION 1.13 “Deliver”, “Deliverable” and “Delivery” shall mean, when used in respect of American Depositary Shares, Receipts, Deposited Securities and Shares, the physical delivery of the certificate representing such security, or the electronic delivery of such security by means of book-entry transfer, as appropriate, including, without limitation, through DRS/Profile. With respect to DRS/Profile ADRs, the terms “execute”, “issue”, “register”, “surrender”, “transfer” or “cancel” refer to applicable entries or movements to or within DRS/Profile.

SECTION 1.14 “Deposit Agreement” shall mean this Deposit Agreement and all exhibits annexed hereto, as the same may from time to time be amended and supplemented in accordance with the terms hereof.

SECTION 1.15 “Depository” shall mean Deutsche Bank Trust Company Americas, an indirect wholly owned subsidiary of Deutsche Bank AG, in its capacity as depository under the terms of this Deposit Agreement, and any successor depository hereunder.

SECTION 1.16 “Deposited Securities” as of any time shall mean Shares at such time deposited or deemed to be deposited under this Deposit Agreement and any and all other securities, property and cash received or deemed to be received by the Depository or the Custodian in respect thereof and held hereunder, subject, in the case of cash, to the provisions of Section 4.6.

SECTION 1.17 “Dollars” and “\$” shall mean the lawful currency of the United States.

SECTION 1.18 “DRS/Profile” shall mean the system for the uncertificated registration of ownership of securities pursuant to which ownership of ADSs is maintained on the books of the Depository without the issuance of a physical certificate and transfer instructions may be given to allow for the automated transfer of ownership between the books of DTC and the Depository. Ownership of ADSs held in DRS/Profile is evidenced by periodic statements issued by the Depository to the Holders entitled thereto.

SECTION 1.19 “DTC” shall mean The Depository Trust Company, the central book-entry clearinghouse and settlement system for securities traded in the United States, and any successor thereto.

SECTION 1.20 “DTC Participants” shall mean participants within DTC.

SECTION 1.21 “Exchange Act” shall mean the U.S. Securities Exchange Act of 1934, as from time to time amended.

SECTION 1.22 “Foreign Currency” shall mean any currency other than Dollars.

SECTION 1.23 “Foreign Registrar” shall mean the entity, if any, that carries out the duties of registrar for the Shares or any successor as registrar for the Shares and any other appointed agent of the Company for the transfer and registration of Shares or, if no such agent is so appointed and acting, the Company.

SECTION 1.24 “Holder” shall mean the person in whose name a Receipt is registered on the books of the Depository (or the Registrar, if any) maintained for such purpose. A Holder may or may not be a Beneficial Owner. A Holder shall be deemed to have all requisite authority to act on behalf of those Beneficial Owners of the ADRs registered in such Holder’s name.



SECTION 1.25 “Indemnified Person” and “Indemnifying Person” shall have the respective meanings set forth in Section 5.8 hereof.

SECTION 1.26 “Losses” shall have the meaning set forth in Section 5.8 hereof.

SECTION 1.27 “Memorandum” shall mean the memorandum of association of the Company.

SECTION 1.28 “Opinion of Counsel” shall mean a written opinion from legal counsel to the Company who is acceptable to the Depository.

SECTION 1.29 “Receipt(s); “American Depository Receipt(s)”; and “ADR(s)” shall mean the certificate(s) or statement(s) issued by the Depository evidencing the American Depository Shares issued under the terms of this Deposit Agreement, as such Receipts may be amended from time to time in accordance with the provisions of this Deposit Agreement. References to Receipts shall include physical certificated Receipts as well as ADSs issued through any book-entry system, including, without limitation, DRS/Profile, unless the context otherwise requires.

SECTION 1.30 “Registrar” shall mean the Depository or any bank or trust company having an office in the Borough of Manhattan, The City of New York, which shall be appointed by the Depository to register ownership of Receipts and transfer of Receipts as herein provided, and shall include any co-registrar appointed by the Depository for such purposes. Registrars (other than the Depository) may be removed and substitutes appointed by the Depository.

SECTION 1.31 “Restricted ADRs” shall have the meaning set forth in Section 2.11 hereof.

SECTION 1.32 “Restricted ADSs” shall have the meaning set forth in Section 2.11 hereof.

SECTION 1.33 “Restricted Securities” shall mean Shares which (i) have been acquired directly or indirectly from the Company or any of its Affiliates in a transaction or chain of transactions not involving any public offering and subject to resale limitations under the Securities Act or the rules issued thereunder, or (ii) are held by an officer or director (or persons performing similar functions) or other Affiliate of the Company or (iii) are subject to other restrictions on sale or deposit under the laws of the United States or the Cayman Islands, under a shareholders’ agreement, shareholders’ lock-up agreement or the Articles of Association or under the regulations of an applicable securities exchange unless, in each case, such Shares are being sold to persons other than an Affiliate of the Company in a transaction (x) covered by an effective resale registration statement or (y) exempt from the registration requirements of the Securities Act (as hereafter defined) and the Shares are not, when held by such person, Restricted Securities.

SECTION 1.34 “Restricted Shares” shall have the meaning set forth in Section 2.11 hereof.

SECTION 1.35 “Securities Act” shall mean the United States Securities Act of 1933, as from time to time amended.

SECTION 1.36 “Shares” shall mean ordinary shares in registered form of the Company, par value \$0.0001 each, heretofore or hereafter validly issued and outstanding and fully paid. References to Shares shall include evidence of rights to receive Shares, whether or not stated in the particular instance; provided, however, that in no event shall Shares include evidence of rights to receive Shares with respect to which the full purchase price has not been paid or Shares as to which pre-emptive rights have theretofore not been validly waived or exercised; provided further, however, that, if there shall occur any change in par value, split-up, consolidation, reclassification, exchange, conversion or any other event described in Section 4.9 hereof in respect of the Shares, the term “Shares” shall thereafter, to the extent permitted by law, represent the successor securities resulting from such change in par value, split-up, consolidation, reclassification, exchange, conversion or event.

SECTION 1.37 “United States” or “U.S.” shall mean the United States of America.

## ARTICLE II.

### APPOINTMENT OF DEPOSITARY; FORM OF RECEIPT; DEPOSIT OF SHARES; EXECUTION AND DELIVERY, TRANSFER AND SURRENDER OF RECEIPTS

SECTION 2.1 Appointment of Depositary. The Company hereby appoints the Depositary as exclusive depositary for the Deposited Securities and hereby authorizes and directs the Depositary to act in accordance with the terms set forth in this Deposit Agreement. Each Holder and each Beneficial Owner, upon acceptance of any ADSs (or any interest therein) issued in accordance with the terms of this Deposit Agreement, shall be deemed for all purposes to (a) be a party to and bound by the terms of this Deposit Agreement and the applicable ADR(s) and (b) appoint the Depositary its attorney-in-fact, with full power to delegate, to act on its behalf and to take any and all actions contemplated in this Deposit Agreement and the applicable ADR(s), to adopt any and all procedures necessary to comply with applicable law and to take such action as the Depositary in its sole discretion may deem necessary or appropriate to carry out the purposes of this Deposit Agreement and the applicable ADR(s) (the taking of such actions to be the conclusive determinant of the necessity and appropriateness thereof).

#### SECTION 2.2 Form and Transferability of Receipts.

(a) Form. Receipts in certificated form shall be substantially in the form set forth in Exhibit A and Exhibit B annexed to this Deposit Agreement, with appropriate insertions, modifications and omissions, as hereinafter provided. Receipts may be issued in denominations of any number of American Depositary Shares. No Receipt in certificated form shall be entitled to any benefits under this Deposit Agreement or be valid or obligatory for any purpose, unless such Receipt shall have been dated and signed by the manual or facsimile signature of a duly authorized signatory of the Depositary. The Depositary shall maintain books on which each Receipt so executed and Delivered, in the case of Receipts in certificated form, and each Receipt issued through any book-entry system, including, without limitation, DRS/Profile, in either case as hereinafter provided, and the transfer of each such Receipt shall be registered. Receipts in certificated form bearing the manual or facsimile signature of a duly authorized signatory of the Depositary who was at any time a proper signatory of the Depositary shall bind the Depositary, notwithstanding the fact that such signatory has ceased to hold such office prior to the execution and Delivery of such Receipts by the Registrar or did not hold such office on the date of issuance of such Receipts.

Notwithstanding anything in this Deposit Agreement or in the form of Receipt to the contrary, to the extent available by the Depository, ADSs shall be evidenced by Receipts issued through any book-entry system, including, without limitation, DRS/Profile, unless certificated Receipts are specifically requested by the Holder. Holders and Beneficial Owners shall be bound by the terms and conditions of this Deposit Agreement and of the form of Receipt, regardless of whether their Receipts are in certificated form or are issued through any book-entry system, including, without limitation, DRS/Profile.

(b) Legends. In addition to the foregoing, the Receipts may, and upon the written request of the Company shall, be endorsed with, or have incorporated in the text thereof, such legends or recitals or modifications not inconsistent with the provisions of this Deposit Agreement as may be (i) necessary to enable the Depository and the Company to perform their respective obligations hereunder, (ii) required to comply with any applicable laws or regulations, or with the rules and regulations of any securities exchange or market upon which ADSs may be traded, listed or quoted, or to conform with any usage with respect thereto, (iii) necessary to indicate any special limitations or restrictions to which any particular ADRs or ADSs are subject by reason of the date of issuance of the Deposited Securities or otherwise or (iv) required by any book-entry system in which the ADSs are held. Holders and Beneficial Owners shall be deemed, for all purposes, to have notice of, and to be bound by, the terms and conditions of the legends set forth, in the case of Holders, on the ADR registered in the name of the applicable Holders or, in the case of Beneficial Owners, on the ADR representing the ADSs owned by such Beneficial Owners.

(c) Title. Subject to the limitations contained herein and in the form of Receipt, title to a Receipt (and to the ADSs evidenced thereby), when properly endorsed (in the case of certificated Receipts) or upon delivery to the Depository of proper instruments of transfer, shall be transferable by delivery with the same effect as in the case of a negotiable instrument under the laws of the State of New York; provided, however, that the Depository, notwithstanding any notice to the contrary, may treat the Holder thereof as the absolute owner thereof for the purpose of determining the person entitled to distribution of dividends or other distributions or to any notice provided for in this Deposit Agreement and for all other purposes and neither the Depository nor the Company will have any obligation or be subject to any liability under this Deposit Agreement to any holder of a Receipt, unless such holder is the Holder thereof.

### SECTION 2.3 Deposits.

(a) Subject to the terms and conditions of this Deposit Agreement and applicable law, Shares or evidence of rights to receive Shares may be deposited by any person (including the Depository in its individual capacity but subject, however, in the case of the Company or any Affiliate of the Company, to Section 5.7 hereof) at any time beginning on the 181<sup>st</sup> day after the date of the prospectus contained in the registration statement on Form F-1 under which the ADSs are first sold or on such earlier date as the Company (with the approval of the underwriters referred to in the said prospectus) may specify in writing to the Depository, whether or not the transfer books of the Company or the Foreign Registrar, if any, are closed, by Delivery of the Shares to the Custodian. Except for Shares deposited by the Company in connection with the initial sale of ADSs under the registration statement on Form F-1, no deposit of Shares shall be accepted under this Deposit Agreement prior to such date. Every deposit of Shares shall be accompanied by the following: (A)(i) in the case of Shares represented by certificates issued in registered form, appropriate instruments of transfer or endorsement, in a form satisfactory to the Custodian, (ii) in the case of Shares represented by certificates issued in bearer form, such Shares or the certificates representing such Shares and (iii) in the case of Shares Delivered by book-entry transfer, confirmation of such book-entry transfer to the Custodian or that irrevocable instructions have been given to cause such Shares to be so transferred, (B) such certifications and payments (including, without limitation, the Depository's fees and related charges) and evidence of such payments (including, without limitation, stamping or otherwise marking such Shares by way of receipt) as may be required by the Depository or the Custodian in accordance with the provisions of this Deposit Agreement or as may be deemed by them to be appropriate in the circumstances, (C) if the Depository so requires, a written order directing the Depository to execute and Deliver to, or upon the written order of, the person or persons stated in such order a Receipt or Receipts for the number of American Depositary Shares representing the Shares so deposited, (D) evidence satisfactory to the Depository (which may include an opinion of counsel reasonably satisfactory to the Depository provided at the cost of the person seeking to deposit Shares) that all conditions to such deposit have been met and all necessary approvals have been granted by, and there has been compliance with the rules and regulations of, any applicable governmental agency and (E) if the Depository so requires, (i) an agreement, assignment or instrument satisfactory to the Depository or the Custodian which provides for the prompt transfer by any person in whose name the Shares are or have been recorded to the Custodian of any distribution, or right to subscribe for additional Shares or to receive other property in respect of any such deposited Shares or, in lieu thereof, such indemnity or other agreement as shall be satisfactory to the Depository or the Custodian and (ii) if the Shares are registered in the name of the person on whose behalf they are presented for deposit, a proxy or proxies entitling the Custodian to exercise voting rights in respect of the Shares for any and all purposes until the Shares so deposited are registered in the name of the Depository, the Custodian or any nominee. No Share shall be accepted for deposit unless accompanied by confirmation or such additional evidence, if any is required by the Depository, that is reasonably satisfactory to the Depository or the Custodian that all conditions to such deposit have been satisfied by the person depositing such Shares under the laws and regulations of the Cayman Islands and any necessary approval has been granted by any governmental body in the Cayman Islands, if any, which is then performing the function of the regulator of currency exchange. The Depository may issue Receipts against evidence of rights to receive Shares from the Company, any agent of the Company or any custodian, registrar, transfer agent, clearing agency or other entity involved in ownership or transaction records in respect of the Shares. Without limitation of the foregoing, the Depository shall not knowingly accept for deposit under this Deposit Agreement any Shares or other Deposited Securities required to be registered under the provisions of the Securities Act, unless a registration statement is in effect as to such Shares or other Deposited Securities, or any Shares or other Deposited Securities the deposit of which would violate any provisions of the Memorandum and Articles of Association. The Depository shall use commercially reasonable efforts to comply with reasonable written instructions of the Company that the Depository shall not accept for deposit hereunder any Shares specifically identified in such instructions at such times and under such circumstances as may reasonably be specified in such instructions in order to facilitate the Company's compliance with the securities laws in the United States and other jurisdictions, provided that the Company shall indemnify the Depository and the Custodian for any claims and losses arising from not accepting the deposit of any Shares identified in the Company's instructions.

(b) As soon as practicable after receipt of any permitted deposit hereunder and compliance with the provisions of this Deposit Agreement, the Custodian shall present the Shares so deposited, together with the appropriate instrument or instruments of transfer or endorsement, duly stamped, to the Foreign Registrar for transfer and registration of the Shares (as soon as transfer and registration can be accomplished and at the expense of the person for whom the deposit is made) in the name of the Depository, the Custodian or a nominee of either. Deposited Securities shall be held by the Depository or by a Custodian for the account and to the order of the Depository or a nominee, in each case for the account of the Holders and Beneficial Owners, at such place or places as the Depository or the Custodian shall determine.

(c) In the event any Shares are deposited which entitle the holders thereof to receive a per-share distribution or other entitlement in an amount different from the Shares then on deposit, the Depository is authorized to take any and all actions as may be necessary (including, without limitation, making the necessary notations on Receipts) to give effect to the issuance of such ADSs and to ensure that such ADSs are not fungible with other ADSs issued hereunder until such time as the entitlement of the Shares represented by such non-fungible ADSs equals that of the Shares represented by ADSs prior to such deposit. The Company agrees to give timely written notice to the Depository if any Shares issued or to be issued contain rights different from those of any other Shares theretofore issued and shall assist the Depository with the establishment of procedures enabling the identification of such non-fungible Shares upon Delivery to the Custodian.

**SECTION 2.4 Execution and Delivery of Receipts** . After the deposit of any Shares pursuant to Section 2.3 hereof, the Custodian shall notify the Depository of such deposit and the person or persons to whom or upon whose written order a Receipt or Receipts are Deliverable in respect thereof and the number of American Depository Shares to be evidenced thereby. Such notification shall be made by letter, first class airmail postage prepaid, or, at the request, risk and expense of the person making the deposit, by cable, telex, SWIFT, facsimile or electronic transmission. After receiving such notice from the Custodian, the Depository, subject to this Deposit Agreement (including, without limitation, the payment of the fees, expenses, taxes and/or other charges owing hereunder), shall issue the ADSs representing the Shares so deposited to or upon the order of the person or persons named in the notice delivered to the Depository and shall execute and Deliver a Receipt registered in the name or names requested by such person or persons evidencing in the aggregate the number of American Depository Shares to which such person or persons are entitled.

**SECTION 2.5 Transfer of Receipts; Combination and Split-up of Receipts** .

(a) **Transfer.** The Depository, or, if a Registrar (other than the Depository) for the Receipts shall have been appointed, the Registrar, subject to the terms and conditions of this Deposit Agreement, shall register transfers of Receipts on its books, upon surrender at the Corporate Trust Office of the Depository of a Receipt by the Holder thereof in person or by duly authorized attorney, properly endorsed in the case of a certificated Receipt or accompanied by, or in the case of Receipts issued through any book-entry system, including, without limitation, DRS/Profile, receipt by the Depository of, proper instruments of transfer (including signature guarantees in accordance with standard industry practice) and duly stamped as may be required by the laws of the State of New York, of the United States, of the Cayman Islands and of any other applicable jurisdiction. Subject to the terms and conditions of this Deposit Agreement, including payment of the applicable fees and charges of the Depository set forth in Section 5.9 hereof and Article (9) of the Receipt, the Depository shall execute a new Receipt or Receipts and Deliver the same to or upon the order of the person entitled thereto evidencing the same aggregate number of American Depository Shares as those evidenced by the Receipts surrendered.

(b) Combination and Split Up. The Depository, subject to the terms and conditions of this Deposit Agreement shall, upon surrender of a Receipt or Receipts for the purpose of effecting a split-up or combination of such Receipt or Receipts and upon payment to the Depository of the applicable fees and charges set forth in Section 5.9 hereof and Article (9) of the Receipt, execute and Deliver a new Receipt or Receipts for any authorized number of American Depositary Shares requested, evidencing the same aggregate number of American Depositary Shares as the Receipt or Receipts surrendered.

(c) Co-Transfer Agents. The Depository may appoint one or more co-transfer agents for the purpose of effecting transfers, combinations and split-ups of Receipts at designated transfer offices on behalf of the Depository. In carrying out its functions, a co-transfer agent may require evidence of authority and compliance with applicable laws and other requirements by Holders or persons entitled to such Receipts and will be entitled to protection and indemnity, in each case to the same extent as the Depository. Such co-transfer agents may be removed and substitutes appointed by the Depository. Each co-transfer agent appointed under this Section 2.5 (other than the Depository) shall give notice in writing to the Depository accepting such appointment and agreeing to be bound by the applicable terms of this Deposit Agreement.

(d) Substitution of Receipts. At the request of a Holder, the Depository shall, for the purpose of substituting a certificated Receipt with a Receipt issued through any book-entry system, including, without limitation, DRS/Profile, or vice versa, execute and Deliver a certificated Receipt or deliver a statement, as the case may be, for any authorized number of ADSs requested, evidencing the same aggregate number of ADSs as those evidenced by the relevant Receipt.

SECTION 2.6 Surrender of Receipts and Withdrawal of Deposited Securities . Upon surrender, at the Corporate Trust Office of the Depository, of American Depositary Shares for the purpose of withdrawal of the Deposited Securities represented thereby, and upon payment of (i) the fees and charges of the Depository for the making of withdrawals of Deposited Securities and cancellation of Receipts (as set forth in Section 5.9 hereof and Article (9) of the Receipt) and (ii) all fees, taxes and/or governmental charges payable in connection with such surrender and withdrawal, and subject to the terms and conditions of this Deposit Agreement, the Memorandum and Articles of Association, Section 7.11 hereof and any other provisions of or governing the Deposited Securities and other applicable laws, the Holder of such American Depositary Shares shall be entitled to Delivery, to him or upon his order, of the Deposited Securities at the time represented by the American Depositary Shares so surrendered. American Depositary Shares may be surrendered for the purpose of withdrawing Deposited Securities by Delivery of a Receipt evidencing such American Depositary Shares (if held in certificated form) or by book-entry Delivery of such American Depositary Shares to the Depository.

A Receipt surrendered for such purposes shall, if so required by the Depository, be properly endorsed in blank or accompanied by proper instruments of transfer in blank, and if the Depository so requires, the Holder thereof shall execute and deliver to the Depository a written order directing the Depository to cause the Deposited Securities being withdrawn to be Delivered to or upon the written order of a person or persons designated in such order. Thereupon, the Depository shall direct the Custodian to Deliver (without unreasonable delay) at the designated office of the Custodian or through a book-entry delivery of the Shares (in either case, subject to Sections 2.7, 3.1, 3.2, 5.9, hereof and to the other terms and conditions of this Deposit Agreement, to the Memorandum and Articles of Association, and to the provisions of or governing the Deposited Securities and applicable laws, now or hereafter in effect) to or upon the written order of the person or persons designated in the order delivered to the Depository as provided above, the Deposited Securities represented by such American Depositary Shares, together with any certificate or other proper documents of or relating to title of the Deposited Securities as may be legally required, as the case may be, to or for the account of such person.

The Depositary may refuse to accept for surrender American Depositary Shares only in the circumstances described in Article (4) of the Receipt. Subject thereto, in the case of surrender of a Receipt evidencing a number of American Depositary Shares representing other than a whole number of Shares, the Depositary shall cause ownership of the appropriate whole number of Shares to be Delivered in accordance with the terms hereof, and shall, at the discretion of the Depositary, either (i) issue and Deliver to the person surrendering such Receipt a new Receipt evidencing American Depositary Shares representing any remaining fractional Share, or (ii) sell or cause to be sold the fractional Shares represented by the Receipt surrendered and remit the proceeds of such sale (net of (a) applicable fees and charges of, and expenses incurred by, the Depositary and/or a division or Affiliate(s) of the Depositary and (b) taxes and/or governmental charges) to the person surrendering the Receipt.

At the request, risk and expense of any Holder so surrendering a Receipt, and for the account of such Holder, the Depositary shall direct the Custodian to forward (to the extent permitted by law) any cash or other property (other than securities) held in respect of, and any certificate or certificates and other proper documents of or relating to title to, the Deposited Securities represented by such Receipt to the Depositary for delivery at the Corporate Trust Office of the Depositary, and for further Delivery to such Holder. Such direction shall be given by letter or, at the request, risk and expense of such Holder, by cable, telex or facsimile transmission. Upon receipt by the Depositary of such direction, the Depositary may make delivery to such person or persons entitled thereto at the Corporate Trust Office of the Depositary of any dividends or cash distributions with respect to the Deposited Securities represented by such American Depositary Shares, or of any proceeds of sale of any dividends, distributions or rights, which may at the time be held by the Depositary.

SECTION 2.7 Limitations on Execution and Delivery, Transfer, etc. of Receipts; Suspension of Delivery, Transfer, etc.

(a) Additional Requirements. As a condition precedent to the execution and Delivery, registration, registration of transfer, split-up, subdivision, combination or surrender of any Receipt, the Delivery of any distribution thereon (whether in cash or shares) or withdrawal of any Deposited Securities, the Depositary or the Custodian may require (i) payment from the depositor of Shares or presenter of the Receipt of a sum sufficient to reimburse it for any tax or other governmental charge and any stock transfer or registration fee with respect thereto (including any such tax or charge and fee with respect to Shares being deposited or withdrawn) and payment of any applicable fees and charges of the Depositary as provided in Section 5.9 hereof and Article (9) of the Receipt hereto, (ii) the production of proof satisfactory to it as to the identity and genuineness of any signature or any other matter contemplated by Section 3.1 hereof and (iii) compliance with (A) any laws or governmental regulations relating to the execution and Delivery of Receipts or American Depositary Shares or to the withdrawal or Delivery of Deposited Securities and (B) such reasonable regulations and procedures as the Depositary may establish consistent with the provisions of this Deposit Agreement and applicable law.

(b) Additional Limitations. The issuance of ADSs against deposits of Shares generally or against deposits of particular Shares may be suspended, or the issuance of ADSs against the deposit of particular Shares may be withheld, or the registration of transfer of Receipts in particular instances may be refused, or the registration of transfers of Receipts generally may be suspended, during any period when the transfer books of the Depositary are closed or if any such action is deemed necessary or advisable by the Depositary or the Company, in good faith, at any time or from time to time because of any requirement of law, any government or governmental body or commission or any securities exchange on which the Receipts or Shares are listed, or under any provision of this Deposit Agreement or provisions of, or governing, the Deposited Securities, or any meeting of shareholders of the Company or for any other reason, subject, in all cases, to Section 7.11 hereof.

(c) The Depositary shall not issue ADSs prior to the receipt of Shares or deliver Shares prior to the receipt and cancellation of ADSs.

SECTION 2.8 Lost Receipts, etc. To the extent the Depositary has issued Receipts in physical certificated form, in case any Receipt shall be mutilated, destroyed, lost or stolen, unless the Depositary has notice that such ADR has been acquired by a bona fide purchaser, subject to Section 5.9 hereof, the Depositary shall execute and Deliver a new Receipt (which, in the discretion of the Depositary may be issued through any book-entry system, including, without limitation, DRS/Profile, unless specifically requested otherwise) in exchange and substitution for such mutilated Receipt upon cancellation thereof, or in lieu of and in substitution for such destroyed, lost or stolen Receipt. Before the Depositary shall execute and Deliver a new Receipt in substitution for a destroyed, lost or stolen Receipt, the Holder thereof shall have (a) filed with the Depositary (i) a request for such execution and Delivery before the Depositary has notice that the Receipt has been acquired by a bona fide purchaser and (ii) a sufficient indemnity bond in form and amount acceptable to the Depositary and (b) satisfied any other reasonable requirements imposed by the Depositary.

SECTION 2.9 Cancellation and Destruction of Surrendered Receipts . All Receipts surrendered to the Depositary shall be cancelled by the Depositary. The Depositary is authorized to destroy Receipts so cancelled in accordance with its customary practices. Cancelled Receipts shall not be entitled to any benefits under this Deposit Agreement or be valid or obligatory for any purpose.

SECTION 2.10 Maintenance of Records . The Depositary agrees to maintain records of all Receipts surrendered and Deposited Securities withdrawn under Section 2.6, substitute Receipts Delivered under Section 2.8 and cancelled or destroyed Receipts under Section 2.9, in keeping with the procedures ordinarily followed by stock transfer agents located in the United States.

SECTION 2.11 Restricted ADSs. At the request and expense of the Company, or at the request and expense of a holder of Shares and with the written consent of the Company, and notwithstanding anything to the contrary in this Deposit Agreement, the Depositary may establish procedures permitting a deposit of Shares that are or may be Restricted Securities (“**Restricted Shares**”) and the Delivery of restricted American Depositary Shares (“**Restricted ADSs**”, the ADRs evidencing such Restricted ADSs being the “**Restricted ADRs**”) representing those Restricted Shares as provided in this Section 2.11. Such procedures shall also govern the removal of the Restrictive Legend (as defined below) from Restricted ADRs, the transfer of Restricted ADRs and the Restricted ADSs evidenced thereby, and the cancellation of Restricted ADRs and withdrawal of Deposited Securities (including Restricted Shares).



- (a) The Company shall assist the Depositary in the establishment of such procedures and agrees that it shall take all steps necessary and reasonably satisfactory to the Depositary to ensure that deposits of Restricted Shares, issuances and transfers of Restricted ADRs and the Restricted ADSs evidenced thereby, and cancellations of Restricted ADRs and withdrawals of Deposited Securities (including Restricted Shares) pursuant to such procedures do not violate the provisions of the Securities Act or any other applicable laws. Depositors of Restricted Shares, holders and transferees of Restricted ADRs and the Restricted ADSs evidenced thereby, and the Company may be required to provide such written certifications and instructions as the Depositary or the Company deem necessary, as well as an appropriate Opinion of Counsel in the Cayman Islands and the United States.
- (b) The Restricted ADSs shall not be eligible for inclusion in any book-entry settlement system, including, without limitation, DTC, and shall be segregated on the Depositary's register as a class of securities separate from, and not fungible with, outstanding American Depositary Shares that are not Restricted ADSs so that Restricted ADSs shall represent interests only in the corresponding Restricted Shares.
- (c) Prior to the deposit of Restricted Shares, the depositor shall deliver to the Depositary a delivery order that (i) discloses or acknowledges all restrictions on transferability of the Restricted Shares (and to that extent need not represent and warrant that the deposited Shares are not Restricted Securities), and (ii) provides that the depositor agrees that the Restricted ADSs will be subject to a specified legend in a form provided by the Company and satisfactory to the Depositary (the "**Restrictive Legend**") that describes those restrictions and agrees to comply with those restrictions.
- (d) Except as otherwise provided in this Section 2.11 and except as required by applicable law, the Restricted ADRs and the Restricted ADSs evidenced thereby shall be treated as ADRs and ADSs issued outstanding under the terms of this Deposit Agreement, all provisions of this Deposit Agreement shall apply to Restricted ADSs. In the event that, in determining the rights and obligations of parties hereto with respect to any Restricted ADSs, any conflict arises between (i) the terms of this Deposit Agreement (other than this Section 2.11) and (ii) the terms of this Section 2.11 or of the applicable Restricted ADR, the terms and conditions set forth in this Section 2.11 and of the Restricted ADR shall be controlling and shall govern the rights and obligations of the parties to this Deposit Agreement pertaining to the deposited Restricted Shares, the Restricted ADSs and Restricted ADRs.

## ARTICLE III.

### CERTAIN OBLIGATIONS OF HOLDERS AND BENEFICIAL OWNERS OF RECEIPTS

SECTION 3.1 Proofs, Certificates and Other Information . Any person presenting Shares for deposit shall provide, any Holder and any Beneficial Owner may be required to provide, and every Holder and Beneficial Owner agrees, from time to time to provide to the Depository or the Custodian such proof of citizenship or residence, taxpayer status, payment of all applicable taxes or other governmental charges, exchange control approval, legal or beneficial ownership of ADSs and Deposited Securities, compliance with applicable laws and the terms of this Deposit Agreement and the provisions of, or governing, the Deposited Securities or other information, to execute such certifications and to make such representations and warranties and to provide such other information and documentation as the Depository may deem necessary or proper or as the Company may reasonably require by written request to the Depository consistent with its obligations hereunder. The Depository and the Registrar, as applicable, may withhold the execution or Delivery or registration of transfer of any Receipt or the distribution or sale of any dividend or other distribution of rights or of the proceeds thereof, or to the extent not limited by the terms of Section 7.11 hereof, the Delivery of any Deposited Securities, until such proof or other information is filed or such certifications are executed, or such representations and warranties are made, or such other documentation or information provided, in each case to the Depository's and the Company's satisfaction. The Depository shall from time to time on the written request of the Company advise the Company of the availability of any such proofs, certificates or other information and shall, at the Company's sole expense, provide or otherwise make available copies thereof to the Company upon written request therefor by the Company, unless such disclosure is prohibited by law. Each Holder and Beneficial Owner agrees to provide, any information requested by the Company or the Depository pursuant to this Section 3.1. Nothing herein shall obligate the Depository to (i) obtain any information for the Company if not provided by the Holders or Beneficial Owners or (ii) verify or vouch for the accuracy of the information so provided by the Holders or Beneficial Owners.

Every Holder and Beneficial Owner agrees to indemnify the Depository, the Company, the Custodian, the Agents and each of their respective directors, officers, employees, agents and Affiliates against, and to hold each of them harmless from, any Losses which any of them may incur or which may be made against any of them as a result of or in connection with any inaccuracy in or omission from any such proof, certificate, representation, warranty, information or document furnished by or on behalf of such Holder and/or Beneficial Owner or as a result of any such failure to furnish any of the foregoing.

The obligations of Holders and Beneficial Owners under Section 3.1 shall survive any transfer of Receipts, any surrender of Receipts or withdrawal of Deposited Securities or the termination of this Deposit Agreement.

SECTION 3.2 Liability for Taxes and Other Charges . If any present or future tax or other governmental charge shall become payable by the Depository or the Custodian with respect to any ADR or any Deposited Securities or American Depositary Shares, such tax or other governmental charge shall be payable by the Holders and Beneficial Owners to the Depository and such Holders and Beneficial Owners shall be deemed liable therefor. The Company, the Custodian and/or the Depository may withhold or deduct from any distributions made in respect of Deposited Securities and may sell for the account of a Holder and/or Beneficial Owner any or all of the Deposited Securities and apply such distributions and sale proceeds in payment of such taxes (including applicable interest and penalties) and charges, with the Holder and the Beneficial Owner remaining fully liable for any deficiency. In addition to any other remedies available to it, the Depository and the Custodian may refuse the deposit of Shares, and the Depository may refuse to issue ADSs, to Deliver ADRs, to register the transfer, split-up or combination of ADRs and (subject to Section 7.11 hereof) the withdrawal of Deposited Securities, until payment in full of such tax, charge, penalty or interest is received. The liability of Holders and Beneficial Owners under this Section 3.2 shall survive any transfer of Receipts, any surrender of Receipts and withdrawal of Deposited Securities or the termination of this Deposit Agreement.

SECTION 3.3 Representations and Warranties on Deposit of Shares . Each person depositing Shares under this Deposit Agreement shall be deemed thereby to represent and warrant that (i) such Shares and the certificates therefor are duly authorized, validly issued, fully paid, non-assessable and were legally obtained by such person, (ii) all preemptive (and similar) rights, if any, with respect to such Shares have been validly waived or exercised, (iii) the person making such deposit is duly authorized so to do, (iv) the Shares presented for deposit are free and clear of any lien, encumbrance, security interest, charge, mortgage or adverse claim and are not, and the American Depositary Shares issuable upon such deposit will not be, Restricted Securities (except as contemplated by Section 2.11), (v) the Shares presented for deposit have not been stripped of any rights or entitlements and (vi) the Shares are not subject to any lock-up agreement with the Company or other party, or the Shares are subject to a lock-up agreement but such lock-up agreement has terminated or the lock-up restrictions imposed thereunder have expired. Such representations and warranties shall survive the deposit and withdrawal of Shares, the issuance and cancellation of American Depositary Shares in respect thereof and the transfer of such American Depositary Shares. If any such representations or warranties are false in any way, the Company and the Depositary shall be authorized, at the cost and expense of the person depositing Shares, to take any and all actions necessary to correct the consequences thereof.

SECTION 3.4 Compliance with Information Requests . Notwithstanding any other provision of this Deposit Agreement, the Articles of Association and applicable law, each Holder and Beneficial Owner agrees to (a) provide such information as the Company or the Depositary may request pursuant to law (including, without limitation, relevant Cayman Islands law, any applicable law of the United States, the Memorandum and Articles of Association, any resolutions of the Company's Board of Directors adopted pursuant to the Memorandum and Articles of Association, the requirements of any markets or exchanges upon which the Shares, ADSs or Receipts are listed or traded, or to any requirements of any electronic book-entry system by which the ADSs or Receipts may be transferred), (b) be bound by and subject to applicable provisions of the laws of the Cayman Islands, the Memorandum and Articles of Association and the requirements of any markets or exchanges upon which the ADSs, Receipts or Shares are listed or traded, or pursuant to any requirements of any electronic book-entry system by which the ADSs, Receipts or Shares may be transferred, to the same extent as if such Holder and Beneficial Owner held Shares directly, in each case irrespective of whether or not they are Holders or Beneficial Owners at the time such request is made and, without limiting the generality of the foregoing, (c) comply with all applicable provisions of Cayman Islands law, the rules and requirements of any stock exchange on which the Shares are, or will be registered, traded or listed and the Articles of Association regarding any such Holder or Beneficial Owner's interest in Shares (including the aggregate of ADSs and Shares held by each such Holder or Beneficial Owner) and/or the disclosure of interests therein, whether or not the same may be enforceable against such Holder or Beneficial Owner. The Depositary agrees to use its reasonable efforts to forward upon the request of the Company, and at the Company's expense, any such request from the Company to the Holders and to forward to the Company any such responses to such requests received by the Depositary.

## ARTICLE IV.

### THE DEPOSITED SECURITIES

SECTION 4.1 Cash Distributions. Whenever the Depositary receives confirmation from the Custodian of receipt of any cash dividend or other cash distribution on any Deposited Securities, or receives proceeds from the sale of any Shares, rights, securities or other entitlements under the terms hereof, the Depositary will, if at the time of receipt thereof any amounts received in a Foreign Currency can in the judgment of the Depositary (pursuant to Section 4.6 hereof) be converted on a practicable basis into Dollars transferable to the United States, promptly convert or cause to be converted such cash dividend, distribution or proceeds into Dollars (on the terms described in Section 4.6 hereof) and will distribute promptly the amount thus received (net of (a) the applicable fees and charges of, and expenses incurred by, the Depositary and/or a division or Affiliate(s) of the Depositary and (b) taxes and/or governmental charges) to the Holders of record as of the ADS Record Date in proportion to the number of American Depositary Shares held by such Holders respectively as of the ADS Record Date. The Depositary shall distribute only such amount, however, as can be distributed without attributing to any Holder a fraction of one cent. Any such fractional amounts shall be rounded down to the nearest whole cent and so distributed to Holders entitled thereto. Holders and Beneficial Owners understand that in converting Foreign Currency, amounts received on conversion are calculated at a rate which exceeds the number of decimal places used by the Depositary to report distribution rates. The excess amount may be retained by the Depositary as an additional cost of conversion, irrespective of any other fees and expenses payable or owing hereunder and shall not be subject to escheatment. If the Company, the Custodian or the Depositary is required to withhold and does withhold from any cash dividend or other cash distribution in respect of any Deposited Securities an amount on account of taxes, duties or other governmental charges, the amount distributed to Holders of the ADSs representing such Deposited Securities shall be reduced accordingly. Such withheld amounts shall be forwarded by the Company, the Custodian or the Depositary to the relevant governmental authority. Evidence of payment thereof by the Company shall be forwarded by the Company to the Depositary upon request. The Depositary shall forward to the Company or its agent such information from its records as the Company may reasonably request to enable the Company or its agent to file with governmental agencies such reports as are necessary to obtain benefits under the applicable tax treaties for the Holders and Beneficial Owners of Receipts.

SECTION 4.2 Distribution in Shares. If any distribution upon any Deposited Securities consists of a dividend in, or free distribution of, Shares, the Company shall cause such Shares to be deposited with the Custodian and registered, as the case may be, in the name of the Depositary, the Custodian or any of their nominees. Upon receipt of confirmation of such deposit from the Custodian, the Depositary shall establish the ADS Record Date upon the terms described in Section 4.7 hereof and shall, subject to Section 5.9 hereof, either (i) distribute to the Holders as of the ADS Record Date in proportion to the number of ADSs held as of the ADS Record Date, additional ADSs, which represent in the aggregate the number of Shares received as such dividend, or free distribution, subject to the other terms of this Deposit Agreement (including, without limitation, (a) the applicable fees and charges of, and expenses incurred by, the Depositary and (b) taxes and/or governmental charges), or (ii) if additional ADSs are not so distributed, each ADS issued and outstanding after the ADS Record Date shall, to the extent permissible by law, thenceforth also represent rights and interests in the additional Shares distributed upon the Deposited Securities represented thereby (net of (a) the applicable fees and charges of, and expenses incurred by, the Depositary and (b) taxes and/or governmental charges). In lieu of Delivering fractional ADSs, the Depositary shall sell the number of Shares represented by the aggregate of such fractions and distribute the proceeds upon the terms described in Section 4.1 hereof. The Depositary may withhold any such distribution of Receipts if it has not received satisfactory assurances from the Company (including an Opinion of Counsel furnished at the expense of the Company) that such distribution does not require registration under the Securities Act or is exempt from registration under the provisions of the Securities Act. To the extent such distribution may be withheld, the Depositary may dispose of all or a portion of such distribution in such amounts and in such manner, including by public or private sale, as the Depositary deems necessary and practicable, and the Depositary shall distribute the net proceeds of any such sale (after deduction of applicable taxes and/or governmental charges and fees and charges of, and expenses incurred by, the Depositary and/or a division or Affiliate(s) of the Depositary) to Holders entitled thereto upon the terms described in Section 4.1 hereof.

SECTION 4.3 Elective Distributions in Cash or Shares . Whenever the Company intends to distribute a dividend payable at the election of the holders of Shares in cash or in additional Shares, the Company shall give notice thereof to the Depository at least 30 days prior to the proposed distribution stating whether or not it wishes such elective distribution to be made available to Holders of ADSs. Upon receipt of notice indicating that the Company wishes such elective distribution to be made available to Holders of ADSs, the Depository shall consult with the Company to determine, and the Company shall assist the Depository in its determination, whether it is lawful and reasonably practicable to make such elective distribution available to the Holders of ADSs. The Depository shall make such elective distribution available to Holders only if (i) the Company shall have timely requested that the elective distribution is available to Holders of ADRs, (ii) the Depository shall have received satisfactory documentation within the terms of Section 5.7 hereof (including, without limitation, any legal opinions of counsel in any applicable jurisdiction that the Depository in its reasonable discretion may request, at the expense of the Company) and (iii) the Depository shall have determined that such distribution is lawful and reasonably practicable. If the above conditions are not satisfied, the Depository shall, to the extent permitted by law, distribute to the Holders, on the basis of the same determination as is made in the local market in respect of the Shares for which no election is made, either cash upon the terms described in Section 4.1 hereof or additional ADSs representing such additional Shares upon the terms described in Section 4.2 hereof. If the above conditions are satisfied, the Depository shall establish an ADS Record Date (on the terms described in Section 4.7 hereof) and establish procedures to enable Holders to elect the receipt of the proposed dividend in cash or in additional ADSs. The Company shall assist the Depository in establishing such procedures to the extent necessary. Subject to Section 5.9 hereof, if a Holder elects to receive the proposed dividend in cash, the dividend shall be distributed upon the terms described in Section 4.1 hereof or in ADSs, the dividend shall be distributed upon the terms described in Section 4.2 hereof. Nothing herein shall obligate the Depository to make available to Holders a method to receive the elective dividend in Shares (rather than ADSs). There can be no assurance that Holders generally, or any Holder in particular, will be given the opportunity to receive elective distributions on the same terms and conditions as the holders of Shares.

SECTION 4.4 Distribution of Rights to Purchase Shares .

(a) Distribution to ADS Holders. Whenever the Company intends to distribute to the holders of the Deposited Securities rights to subscribe for additional Shares, the Company shall give notice thereof to the Depository at least 45 days prior to the proposed distribution stating whether or not it wishes such rights to be made available to Holders of ADSs. Upon timely receipt of a notice indicating that the Company wishes such rights to be made available to Holders of ADSs, the Depository shall consult with the Company to determine, and the Company shall determine, whether it is lawful and reasonably practicable to make such rights available to the Holders. The Depository shall make such rights available to Holders only if (i) the Company shall have timely requested that such rights be made available to Holders, (ii) the Depository shall have received satisfactory documentation within the terms of Section 5.7 hereof and (iii) the Depository shall have determined that such distribution of rights is lawful and reasonably practicable. In the event any of the conditions set forth above are not satisfied, the Depository shall proceed with the sale of the rights as contemplated in Section 4.4(b) below or, if timing or market conditions may not permit, do nothing thereby allowing such rights to lapse. In the event all conditions set forth above are satisfied, the Depository shall establish an ADS Record Date (upon the terms described in Section 4.7 hereof) and establish procedures to distribute such rights (by means of warrants or otherwise) and to enable the Holders to exercise the rights (upon payment of applicable fees and charges of, and expenses incurred by, the Depository and taxes and/or other governmental charges). Nothing herein shall obligate the Depository to make available to the Holders a method to exercise such rights to subscribe for Shares (rather than ADSs).

(b) Sale of Rights. If (i) the Company does not timely request the Depositary to make the rights available to Holders or requests that the rights not be made available to Holders, (ii) the Depositary fails to receive satisfactory documentation within the terms of Section 5.7 hereof or determines it is not lawful or reasonably practicable to make the rights available to Holders or (iii) any rights made available are not exercised and appear to be about to lapse, the Depositary shall determine whether it is lawful and reasonably practicable to sell such rights, and if it so determines that it is lawful and reasonably practicable, endeavour to sell such rights in a riskless principal capacity or otherwise, at such place and upon such terms (including public or private sale) as it may deem proper. The Company shall assist the Depositary to the extent necessary to determine such legality and practicability. The Depositary shall, upon such sale, convert and distribute proceeds of such sale (net of applicable fees and charges of, and expenses incurred by, the Depositary and/or a division or Affiliate(s) of the Depositary and taxes and/or governmental charges) upon the terms set forth in Section 4.1 hereof.

(c) Lapse of Rights. If the Depositary is unable to make any rights available to Holders upon the terms described in Section 4.4(a) hereof or to arrange for the sale of the rights upon the terms described in Section 4.4(b) hereof, the Depositary shall allow such rights to lapse.

The Depositary shall not be responsible for (i) any failure to determine that it may be lawful or practicable to make such rights available to Holders in general or any Holders in particular, (ii) any foreign exchange exposure or loss incurred in connection with such sale or exercise or (iii) the content of any materials forwarded to the Holders on behalf of the Company in connection with the rights distribution.

Notwithstanding anything to the contrary in this Section 4.4, if registration (under the Securities Act or any other applicable law) of the rights or the securities to which any rights relate may be required in order for the Company to offer such rights or such securities to Holders and to sell the securities represented by such rights, the Depositary will not distribute such rights to the Holders (i) unless and until a registration statement under the Securities Act covering such offering is in effect or (ii) unless the Company furnishes at its expense the Depositary with opinion(s) of counsel for the Company in the United States and counsel to the Company in any other applicable country in which rights would be distributed, in each case satisfactory to the Depositary, to the effect that the offering and sale of such securities to Holders and Beneficial Owners are exempt from, or do not require registration under, the provisions of the Securities Act or any other applicable laws. In the event that the Company, the Depositary or the Custodian shall be required to withhold and does withhold from any distribution of property (including rights) an amount on account of taxes and/or other governmental charges, the amount distributed to the Holders shall be reduced accordingly. In the event that the Depositary determines that any distribution in property (including Shares and rights to subscribe therefor) is subject to any tax or other governmental charges which the Depositary is obligated to withhold, the Depositary may dispose of all or a portion of such property (including Shares and rights to subscribe therefor) in such amounts and in such manner, including by public or private sale, as the Depositary deems necessary and practicable to pay any such taxes and/or charges.

There can be no assurance that Holders generally, or any Holder in particular, will be given the opportunity to exercise rights on the same terms and conditions as the holders of Shares or be able to exercise such rights. Nothing herein shall obligate the Company to file any registration statement in respect of any rights or Shares or other securities to be acquired upon the exercise of such rights or otherwise to register or qualify the offer or sale of such rights or securities under the applicable law of any other jurisdiction for any purpose.

SECTION 4.5 Distributions Other Than Cash, Shares or Rights to Purchase Shares

(a) Whenever the Company intends to distribute to the holders of Deposited Securities property other than cash, Shares or rights to purchase additional Shares, the Company shall give notice thereof to the Depositary at least 30 days prior to the proposed distribution and shall indicate whether or not it wishes such distribution to be made to Holders of ADSs. Upon receipt of a notice indicating that the Company wishes such distribution be made to Holders of ADSs, the Depositary shall determine whether such distribution to Holders is lawful and practicable. The Depositary shall not make such distribution unless (i) the Company shall have timely requested the Depositary to make such distribution to Holders, (ii) the Depositary shall have received satisfactory documentation within the terms of Section 5.7 hereof and (iii) the Depositary shall have determined that such distribution is lawful and reasonably practicable.

(b) Upon receipt of satisfactory documentation and the request of the Company to distribute property to Holders of ADSs and after making the requisite determinations set forth in (a) above, the Depositary may distribute the property so received to the Holders of record as of the ADS Record Date, in proportion to the number of ADSs held by such Holders respectively and in such manner as the Depositary may deem practicable for accomplishing such distribution (i) upon receipt of payment or net of the applicable fees and charges of, and expenses incurred by, the Depositary and (ii) net of any taxes and/or other governmental charges. The Depositary may dispose of all or a portion of the property so distributed and deposited, in such amounts and in such manner (including public or private sale) as the Depositary may deem practicable or necessary to satisfy any taxes (including applicable interest and penalties) and other governmental charges applicable to the distribution.

(c) If (i) the Company does not request the Depositary to make such distribution to Holders or requests the Depositary not to make such distribution to Holders, (ii) the Depositary does not receive satisfactory documentation within the terms of Section 5.7 hereof or (iii) the Depositary determines that all or a portion of such distribution is not reasonably practicable or feasible, the Depositary shall endeavor to sell or cause such property to be sold in a public or private sale, at such place or places and upon such terms as it may deem proper and shall distribute the net proceeds, if any, of such sale received by the Depositary (net of applicable fees and charges of, and expenses incurred by, the Depositary and/or a division or Affiliate(s) of the Depositary and taxes and/or governmental charges) to the Holders as of the ADS Record Date upon the terms of Section 4.1 hereof. If the Depositary is unable to sell such property, the Depositary may dispose of such property in any way it deems reasonably practicable under the circumstances for nominal or no consideration and Holders and Beneficial Owners shall have no rights thereto or arising therefrom.

SECTION 4.6 Conversion of Foreign Currency. Whenever the Depositary or the Custodian shall receive Foreign Currency, by way of dividends or other distributions or the net proceeds from the sale of securities, property or rights, and in the judgment of the Depositary such Foreign Currency can at such time be converted on a practicable basis (by sale or in any other manner that it may determine in accordance with applicable law) into Dollars transferable to the United States and distributable to the Holders entitled thereto, the Depositary shall convert or cause to be converted, by sale or in any other manner that it may determine, such Foreign Currency into Dollars, and shall distribute such Dollars (net of any fees, expenses, taxes and/or other governmental charges incurred in the process of such conversion) in accordance with the terms of the applicable sections of this Deposit Agreement. If the Depositary shall have distributed warrants or other instruments that entitle the holders thereof to such Dollars, the Depositary shall distribute such Dollars to the holders of such warrants and/or instruments upon surrender thereof for cancellation, in either case without liability for interest thereon. Such distribution may be made upon an averaged or other practicable basis without regard to any distinctions among Holders on account of exchange restrictions, the date of delivery of any Receipt or otherwise.

In converting Foreign Currency, amounts received on conversion may be calculated at a rate which exceeds the number of decimal places used by the Depositary to report distribution rates (which in any case will not be less than two decimal places). Any excess amount may be retained by the Depositary as an additional cost of conversion, irrespective of any other fees and expenses payable or owing hereunder and shall not be subject to escheatment.

If such conversion or distribution can be effected only with the approval or license of any government or agency thereof, the Depositary may file such application for approval or license, if any, as it may deem necessary, practicable and at nominal cost and expense. Nothing herein shall obligate the Depositary to file or cause to be filed, or to seek effectiveness of any such application or license.

If at any time the Depositary shall determine that in its judgment the conversion of any Foreign Currency and the transfer and distribution of proceeds of such conversion received by the Depositary is not practical or lawful, or if any approval or license of any governmental authority or agency thereof that is required for such conversion, transfer and distribution is denied, or not obtainable at a reasonable cost, within a reasonable period or otherwise sought, the Depositary shall, in its sole discretion but subject to applicable laws and regulations, either (i) distribute the Foreign Currency (or an appropriate document evidencing the right to receive such Foreign Currency) received by the Depositary to the Holders entitled to receive such Foreign Currency or (ii) hold such Foreign Currency uninvested and without liability for interest thereon for the respective accounts of the Holders entitled to receive the same.

Holders and Beneficial Owners are directed to refer to Section 7.9 hereof for certain disclosure related to conversion of Foreign Currency.

SECTION 4.7 Fixing of Record Date. Whenever necessary in connection with any distribution (whether in cash, Shares, rights, or other distribution), or whenever for any reason the Depositary causes a change in the number of Shares that are represented by each American Depositary Share, or whenever the Depositary shall receive notice of any meeting of or solicitation of holders of Shares or other Deposited Securities, or whenever the Depositary shall find it necessary or convenient, the Depositary shall fix a record date (the "ADS Record Date"), as close as practicable to the record date fixed by the Company with respect to the Shares (if applicable), for the determination of the Holders who shall be entitled to receive such distribution, to give instructions for the exercise of voting rights at any such meeting, to give or withhold such consent, to receive such notice or solicitation or to otherwise take action or to exercise the rights of Holders with respect to such changed number of Shares represented by each American Depositary Share or for any other reason. Subject to applicable law and the provisions of Sections 4.1 through 4.6 hereof and to the other terms and conditions of this Deposit Agreement, only the Holders of record at the close of business in New York on such ADS Record Date shall be entitled to receive such distribution, to give such voting instructions, to receive such notice or solicitation, or otherwise take action.



SECTION 4.8 Voting of Deposited Securities . Subject to the next sentence, as soon as practicable after receipt of notice of any meeting at which the holders of Deposited Securities are entitled to vote, or of solicitation of consents or proxies from holders of Deposited Securities, the Depositary shall fix the ADS Record Date in respect of such meeting or such solicitation of consents or proxies. The Depositary shall, if requested by the Company in writing in a timely manner (the Depositary having no obligation to take any further action if the request shall not have been received by the Depositary at least 30 Business Days prior to the date of such vote or meeting) and at the Company's expense, and provided no U.S. legal prohibitions exist, mail by regular, ordinary mail delivery (or by electronic mail or as otherwise may be agreed between the Company and the Depositary in writing from time to time) or otherwise distribute as soon as practicable after receipt thereof to Holders as of the ADS Record Date: (a) such notice of meeting or solicitation of consent or proxy; (b) a statement that the Holders at the close of business on the ADS Record Date will be entitled, subject to any applicable law, the provisions of this Deposit Agreement, the Company's Memorandum and Articles of Association and the provisions of or governing the Deposited Securities (which provisions, if any, shall be summarized in pertinent part by the Company), to instruct the Depositary as to the exercise of the voting rights, if any, pertaining to the Deposited Securities represented by such Holder's American Depositary Shares; and (c) a brief statement as to the manner in which such voting instructions may be given to the Depositary, or in which instructions may be deemed to have been given in accordance with this Section 4.8, including an express indication that instructions may be given (or be deemed to have been given in accordance with the immediately following paragraph of this section if no instruction is received) to the Depositary to give a discretionary proxy to a person or persons designated by the Company. Voting instructions may be given only in respect of a number of American Depositary Shares representing an integral number of Deposited Securities. Upon the timely receipt of voting instructions of a Holder on the ADS Record Date in the manner specified by the Depositary, the Depositary shall endeavor, insofar as practicable and permitted under applicable law, the provisions of this Deposit Agreement, the Company's Memorandum and Articles of Association and the provisions of or governing the Deposited Securities, to vote or cause the Custodian to vote the Deposited Securities (in person or by proxy) represented by American Depositary Shares evidenced by such Receipt in accordance with such voting instructions.

In the event that (i) the Depositary timely receives voting instructions from a Holder which fail to specify the manner in which the Depositary is to vote the Deposited Securities represented by such Holder's ADSs or (ii) no timely instructions are received by the Depositary from a Holder with respect to any of the Deposited Securities represented by the ADSs held by such Holder on the ADS Record Date, the Depositary shall (unless otherwise specified in the notice distributed to Holders) deem such Holder to have instructed the Depositary to give a discretionary proxy to a person designated by the Company with respect to such Deposited Securities and the Depositary shall give a discretionary proxy to a person designated by the Company to vote such Deposited Securities, provided, however, that no such instruction shall be deemed to have been given and no such discretionary proxy shall be given with respect to any matter as to which the Company informs the Depositary (and the Company agrees to provide such information as promptly as practicable in writing, if applicable) that (x) the Company does not wish to give such proxy, (y) the Company is aware or should reasonably be aware that substantial opposition exists from Holders against the outcome for which the person designated by the Company would otherwise vote or (z) the outcome for which the person designated by the Company would otherwise vote would materially and adversely affect the rights of holders of Deposited Securities, provided, further, that the Company will have no liability to any Holder or Beneficial Owner resulting from such notification.

In the event that voting on any resolution or matter is conducted on a show of hands basis in accordance with the Memorandum and Articles of Association, the Depositary will refrain from voting and the voting instructions (or the deemed voting instructions, as set out above) received by the Depositary from Holders shall lapse. The Depositary will have no obligation to demand voting on a poll basis with respect to any resolution and shall have no liability to any Holder or Beneficial Owner for not having demanded voting on a poll basis.

Neither the Depositary nor the Custodian shall, under any circumstances exercise any discretion as to voting, and neither the Depositary nor the Custodian shall vote, attempt to exercise the right to vote, or in any way make use of for purposes of establishing a quorum or otherwise, the Deposited Securities represented by ADSs except pursuant to and in accordance with such written instructions from Holders, including the deemed instruction to the Depositary to give a discretionary proxy to a person designated by the Company. Deposited Securities represented by ADSs for which (i) no timely voting instructions are received by the Depositary from the Holder, or (ii) timely voting instructions are received by the Depositary from the Holder but such voting instructions fail to specify the manner in which the Depositary is to vote the Deposited Securities represented by such Holder's ADSs, shall be voted in the manner provided in this Section 4.8. Notwithstanding anything else contained herein, and subject to applicable law, regulation and the Memorandum and Articles of Association, the Depositary shall, if so requested in writing by the Company, represent all Deposited Securities (whether or not voting instructions have been received in respect of such Deposited Securities from Holders as of the ADS Record Date) for the purpose of establishing quorum at a meeting of shareholders.

There can be no assurance that Holders or Beneficial Owners generally or any Holder or Beneficial Owner in particular will receive the notice described above with sufficient time to enable the Holder to return voting instructions to the Depositary in a timely manner.

Notwithstanding the above, save for applicable provisions of the law of the Cayman Islands, and in accordance with the terms of Section 5.3 hereof, the Depositary shall not be liable for any failure to carry out any instructions to vote any of the Deposited Securities or the manner in which such vote is cast or the effect of such vote.

SECTION 4.9 Changes Affecting Deposited Securities. Upon any change in par value, split-up, subdivision, cancellation, consolidation or any other reclassification of Deposited Securities or upon any recapitalization, reorganization, amalgamation, merger or consolidation or sale of assets affecting the Company or to which it is otherwise a party, any securities which shall be received by the Depositary or the Custodian in exchange for, or in conversion of or replacement or otherwise in respect of, such Deposited Securities shall, to the extent permitted by law, be treated as new Deposited Securities under this Deposit Agreement and the Receipts shall, subject to the provisions of this Deposit Agreement and applicable law, evidence American Depositary Shares representing the right to receive such additional securities. Alternatively, the Depositary may, with the Company's approval, and shall, if the Company shall so request, subject to the terms of this Deposit Agreement and receipt of an Opinion of Counsel furnished at the Company's expense satisfactory to the Depositary (stating that such distributions are not in violation of any applicable laws or regulations), execute and deliver additional Receipts, as in the case of a stock dividend on the Shares, or call for the surrender of outstanding Receipts to be exchanged for new Receipts. In either case, as well as in the event of newly deposited Shares, necessary modifications to the form of Receipt contained in Exhibit A and Exhibit B hereto, specifically describing such new Deposited Securities and/or corporate change, shall also be made. The Company agrees that it will, jointly with the Depositary, amend the Registration Statement on Form F-6 as filed with the Commission to permit the issuance of such new form of Receipt. Notwithstanding the foregoing, in the event that any security so received may not be lawfully distributed to some or all Holders, the Depositary may, with the Company's approval, and shall, if the Company requests, subject to receipt of an Opinion of Counsel (furnished at the Company's expense) satisfactory to the Depositary that such action is not in violation of any applicable laws or regulations, sell such securities at public or private sale, at such place or places and upon such terms as it may deem proper and may allocate the net proceeds of such sales (net of fees and charges of, and expenses incurred by, the Depositary and/or a division or Affiliate(s) of the Depositary and taxes and/or governmental charges) for the account of the Holders otherwise entitled to such securities upon an averaged or other practicable basis without regard to any distinctions among such Holders and distribute the net proceeds so allocated to the extent practicable as in the case of a distribution received in cash pursuant to Section 4.1 hereof. The Depositary shall not be responsible for (i) any failure to determine that it may be lawful or feasible to make such securities available to Holders in general or to any Holder in particular, (ii) any foreign exchange exposure or loss incurred in connection with such sale or (iii) any liability to the purchaser of such securities.

SECTION 4.10 Available Information. The Company is subject to the periodic reporting requirements of the Exchange Act applicable to foreign private issuers (as defined in Rule 405 of the Securities Act) and accordingly files certain information with the Commission. These reports and documents can be inspected and copied at the Commission's website at [www.sec.gov](http://www.sec.gov) or at the public reference facilities maintained by the Commission located at 100 F Street, N.E., Washington D.C. 20549, U.S.A.

SECTION 4.11 Reports. The Depositary shall make available during normal business hours on any Business Day for inspection by Holders at its Corporate Trust Office any reports and communications, including any proxy soliciting materials, received from the Company which are both received by the Depositary, the Custodian, or the nominee of either of them as the holder of the Deposited Securities and made generally available to the holders of such Deposited Securities by the Company. The Company agrees to provide to the Depositary, at the Company's expense, all such documents that it provides to the Custodian. Unless otherwise agreed in writing by the Company and the Depositary, the Depositary shall, at the expense of the Company and in accordance with Section 5.6 hereof, also mail to Holders by regular, ordinary mail delivery or by electronic transmission (if agreed by the Company and the Depositary) copies of notices and reports when furnished by the Company pursuant to Section 5.6 hereof.

SECTION 4.12 List of Holders. Promptly upon written request by the Company, the Depository shall, at the expense of the Company, furnish to it a list, as of a recent date, of the names, addresses and holdings of American Depositary Shares by all persons in whose names Receipts are registered on the books of the Depository.

SECTION 4.13 Taxation; Withholding. The Depository will, and will instruct the Custodian to, forward to the Company or its agents such information from its records as the Company may request to enable the Company or its agents to file necessary tax reports with governmental authorities or agencies. The Depository, the Custodian or the Company and its agents may, but shall not be obligated to, file such reports as are necessary to reduce or eliminate applicable taxes on dividends and on other distributions in respect of Deposited Securities under applicable tax treaties or laws for the Holders and Beneficial Owners. Holders and Beneficial Owners of American Depositary Shares may be required from time to time, and in a timely manner to provide and/or file such proof of taxpayer status, residence and beneficial ownership (as applicable), to execute such certificates and to make such representations and warranties, or to provide any other information or documents, as the Depository or the Custodian may deem necessary or proper to fulfill the Depository's or the Custodian's obligations under applicable law. The Holders and Beneficial Owners shall indemnify the Depository, the Company, the Custodian, the Agents and their respective directors, officers, employees, agents and Affiliates against, and hold each of them harmless from, any claims by any governmental authority with respect to taxes, additions to tax, penalties or interest arising out of any refund of taxes, reduced rate of withholding at source or other tax benefit obtained by the Beneficial Owner or Holder or out of or in connection with any inaccuracy in or omission from any such proof, certificate, representation, warranty, information or document furnished by or on behalf of such Holder or Beneficial Owner. The obligations of Holders and Beneficial Owners under this Section 4.13 shall survive any transfer of Receipts, any surrender of Receipts and withdrawal of Deposited Securities or the termination of this Deposit Agreement.

The Company shall remit to the appropriate governmental authority or agency any amounts required to be withheld by the Company and owing to such governmental authority or agency. Upon any such withholding, the Company shall remit to the Depository information, in a form reasonably satisfactory to the Depository, about such taxes and/or governmental charges withheld or paid, and, if so requested, the tax receipt (or other proof of payment to the applicable governmental authority) therefor. The Depository shall, to the extent required by U.S. law, report to Holders (i) any taxes withheld by it; (ii) any taxes withheld by the Custodian, subject to information being provided to the Depository by the Custodian and (iii) any taxes withheld by the Company, subject to information being provided to the Depository by the Company. The Depository and the Custodian shall not be required to provide the Holders with any evidence of the remittance by the Company (or its agents) of any taxes withheld, or of the payment of taxes by the Company, except to the extent the evidence is provided by the Company to the Depository. None of the Depository, the Custodian or the Company shall be liable for the failure by any Holder or Beneficial Owner to obtain the benefits of credits on the basis of non-U.S. tax paid against such Holder's or Beneficial Owner's income tax liability.

In the event that the Depository determines that any distribution in property (including Shares and rights to subscribe therefor) is subject to any tax or other governmental charge which the Depository is obligated to withhold, the Depository shall withhold the amount required to be withheld and may by public or private sale dispose of all or a portion of such property (including Shares and rights to subscribe therefor) in such amounts and in such manner as the Depository deems necessary and practicable to pay such taxes and/or charges and the Depository shall distribute the net proceeds of any such sale after deduction of such taxes and/or charges to the Holders entitled thereto in proportion to the number of American Depositary Shares held by them respectively.

The Depositary is under no obligation to provide the Holders and Beneficial Owners with any information about the tax status of the Company. The Depositary shall not incur any liability for any tax consequences that may be incurred by Holders and Beneficial Owners on account of their ownership of the American Depositary Shares, including without limitation, tax consequences resulting from the Company (or any of its subsidiaries) being treated as a "Passive Foreign Investment Company" (as defined in the U.S. Internal Revenue Code of 1986, as amended and the regulations issued thereunder) or otherwise.

## ARTICLE V.

### THE DEPOSITARY, THE CUSTODIAN AND THE COMPANY

SECTION 5.1 Maintenance of Office and Transfer Books by the Registrar. Until termination of this Deposit Agreement in accordance with its terms, the Depositary or if a Registrar for the Receipts shall have been appointed, the Registrar shall maintain in the Borough of Manhattan, the City of New York, an office and facilities for the execution and delivery, registration, registration of transfers, combination and split-up of Receipts, the surrender of Receipts and the Delivery and withdrawal of Deposited Securities in accordance with the provisions of this Deposit Agreement.

The Depositary or the Registrar as applicable, shall keep books for the registration of Receipts and transfers of Receipts which at all reasonable times shall be open for inspection by the Company and by the Holders of such Receipts, provided that such inspection shall not be, to the Depositary's or the Registrar's knowledge, for the purpose of communicating with Holders of such Receipts in the interest of a business or object other than the business of the Company or other than a matter related to this Deposit Agreement or the Receipts.

The Depositary or the Registrar, as applicable, may close the transfer books with respect to the Receipts, at any time and from time to time, when deemed necessary or advisable by it in connection with the performance of its duties hereunder, or at the reasonable written request of the Company.

If any Receipts or the American Depositary Shares evidenced thereby are listed on one or more stock exchanges or automated quotation systems in the United States, the Depositary shall act as Registrar or appoint a Registrar or one or more co-registrars for registration of Receipts and transfers, combinations and split-ups, and to countersign such Receipts in accordance with any requirements of such exchanges or systems. Such Registrar or co-registrars may be removed and a substitute or substitutes appointed by the Depositary.

If any Receipts or the American Depositary Shares evidenced thereby are listed on one or more securities exchanges, markets or automated quotation systems, (i) the Depositary shall be entitled to, and shall, take or refrain from taking such action(s) as it may deem necessary or appropriate to comply with the requirements of such securities exchange(s), market(s) or automated quotation system(s) applicable to it, notwithstanding any other provision of this Deposit Agreement; and (ii) upon the reasonable request of the Depositary, the Company shall provide the Depositary such information and assistance as may be reasonably necessary for the Depositary to comply with such requirements, to the extent that the Company may lawfully do so.

Each Registrar and co-registrar appointed under this Section 5.1 shall give notice in writing to the Depository accepting such appointment and agreeing to be bound by the applicable terms of this Deposit Agreement.

SECTION 5.2 Exoneration. None of the Depository, the Custodian or the Company shall be obligated to do or perform any act which is inconsistent with the provisions of this Deposit Agreement or shall incur any liability to Holders, Beneficial Owners or any third parties (i) if the Depository, the Custodian or the Company or their respective controlling persons or agents (including without limitation, the Agents) shall be prevented or forbidden from, or delayed in, doing or performing any act or thing required by the terms of this Deposit Agreement, by reason of any provision of any present or future law or regulation of the United States or any state thereof, the Cayman Islands or any other country, or of any other governmental authority or regulatory authority or stock exchange, or on account of the possible criminal or civil penalties or restraint, or by reason of any provision, present or future, of the Memorandum and Articles of Association or any provision of or governing any Deposited Securities, or by reason of any act of God or war or other circumstances beyond its control (including, without limitation, nationalization, expropriation, currency restrictions, work stoppage, strikes, civil unrest, revolutions, rebellions, explosions and computer failure), (ii) by reason of any exercise of, or failure to exercise, any discretion provided for in this Deposit Agreement or in the Memorandum and Articles of Association or provisions of or governing Deposited Securities, (iii) for any action or inaction of the Depository, the Custodian or the Company or their respective controlling persons or agents (including without limitation, the Agents) in reliance upon the advice of or information from legal counsel, accountants, any person presenting Shares for deposit, any Holder, any Beneficial Owner or authorized representative thereof, or any other person believed by it in good faith to be competent to give such advice or information, (iv) for the inability by a Holder or Beneficial Owner to benefit from any distribution, offering, right or other benefit which is made available to holders of Deposited Securities but is not, under the terms of this Deposit Agreement, made available to Holders of American Depositary Shares or (v) for any special, consequential, indirect or punitive damages for any breach of the terms of this Deposit Agreement or otherwise.

The Depository, its controlling persons, its agents (including without limitation, the Agents), the Custodian and the Company, its controlling persons and its agents may rely and shall be protected in acting upon any written notice, request, opinion or other document believed by it to be genuine and to have been signed or presented by the proper party or parties.

No disclaimer of liability under the Securities Act or the Exchange Act is intended by any provision of this Deposit Agreement.

SECTION 5.3 Standard of Care. The Company and the Depository and their respective directors, officers, Affiliates, employees and agents (including without limitation, the Agents) assume no obligation and shall not be subject to any liability under this Deposit Agreement or any Receipts to any Holder(s) or Beneficial Owner(s) or other persons, except in accordance with Section 5.8 hereof, provided, that the Company and the Depository and their respective directors, officers, Affiliates, employees and agents (including without limitation, the Agents) agree to perform their respective obligations specifically set forth in this Deposit Agreement or the applicable ADRs without gross negligence or willful misconduct.

Without limitation of the foregoing, neither the Depositary, nor the Company, nor any of their respective controlling persons, directors, officers, affiliates, employees or agents (including without limitation, the Agents), shall be under any obligation to appear in, prosecute or defend any action, suit or other proceeding in respect of any Deposited Securities or in respect of the Receipts, which in its opinion may involve it in expense or liability, unless indemnity satisfactory to it against all expenses (including fees and disbursements of counsel) and liabilities be furnished as often as may be required (and no Custodian shall be under any obligation whatsoever with respect to such proceedings, the responsibility of the Custodian being solely to the Depositary).

The Depositary and its directors, officers, affiliates, employees and agents (including without limitation, the Agents) shall not be liable for any failure to carry out any instructions to vote any of the Deposited Securities, or for the manner in which any vote is cast or the effects of any vote. The Depositary shall not incur any liability for any failure to determine that any distribution or action may be lawful or reasonably practicable, for the content of any information submitted to it by the Company for distribution to the Holders or for any inaccuracy of any translation thereof, for any investment risk associated with acquiring an interest in the Deposited Securities, for the validity or worth of the Deposited Securities or for any tax consequences that may result from the ownership of ADSs, Shares or Deposited Securities, for the credit-worthiness of any third party, for allowing any rights to lapse upon the terms of this Deposit Agreement or for the failure or timeliness of any notice from the Company, or for any action or non action by it in reliance upon the opinion, advice of or information from legal counsel, accountants, any person presenting Shares for deposit, any Holder or any other person believed by it in good faith to be competent to give such advice or information. The Depositary and its agents (including without limitation, the Agents) shall not be liable for any acts or omissions made by a successor depositary whether in connection with a previous act or omission of the Depositary or in connection with any matter arising wholly after the removal or resignation of the Depositary, provided that in connection with the issue out of which such potential liability arises the Depositary performed its obligations without gross negligence or willful misconduct while it acted as Depositary.

SECTION 5.4 Resignation and Removal of the Depositary; Appointment of Successor Depositary. The Depositary may at any time resign as Depositary hereunder by written notice of resignation delivered to the Company, such resignation to be effective on the earlier of (i) the 90th day after delivery thereof to the Company (whereupon the Depositary shall, in the event no successor depositary has been appointed by the Company, be entitled to take the actions contemplated in Section 6.2 hereof) and (ii) the appointment by the Company of a successor depositary and its acceptance of such appointment as hereinafter provided, save that, any amounts, fees, costs or expenses owed to the Depositary hereunder or in accordance with any other agreements otherwise agreed in writing between the Company and the Depositary from time to time shall be paid to the Depositary prior to such resignation.

The Company shall use reasonable efforts to appoint such successor depositary, and give notice to the Depositary of such appointment, not more than 90 days after delivery by the Depositary of written notice of resignation as provided in this Section 5.4. In the event that notice of the appointment of a successor depositary is not provided by the Company in accordance with the preceding sentence, the Depositary shall be entitled to take the actions contemplated in Section 6.2 hereof.

The Depositary may at any time be removed by the Company by written notice of such removal, which removal shall be effective on the later of (i) the 90th day after delivery thereof to the Depositary (whereupon the Depositary shall be entitled to take the actions contemplated in Section 6.2 hereof if a successor depositary has not been appointed), and (ii) the appointment by the Company of a successor depositary and its acceptance of such appointment as hereinafter provided, save that, any amounts, fees, costs or expenses owed to the Depositary hereunder or in accordance with any other agreements otherwise agreed in writing between the Company and the Depositary from time to time shall be paid to the Depositary prior to such removal.

In case at any time the Depositary acting hereunder shall resign or be removed, the Company shall use its best efforts to appoint a successor depositary, which shall be a bank or trust company having an office in the Borough of Manhattan, the City of New York. Every successor depositary shall be required by the Company to execute and deliver to its predecessor and to the Company an instrument in writing accepting its appointment hereunder, and thereupon such successor depositary, without any further act or deed (except as required by applicable law), shall become fully vested with all the rights, powers, duties and obligations of its predecessor. The predecessor depositary, upon payment of all sums due to it and on the written request of the Company, shall (i) execute and deliver an instrument transferring to such successor all rights and powers of such predecessor hereunder (other than as contemplated in Sections 5.8 and 5.9 hereof), (ii) duly assign, transfer and deliver all right, title and interest to the Deposited Securities to such successor, and (iii) deliver to such successor a list of the Holders of all outstanding Receipts and such other information relating to Receipts and Holders thereof as the successor may reasonably request. Any such successor depositary shall promptly mail notice of its appointment to such Holders.

Any corporation into or with which the Depositary may be merged or consolidated shall be the successor of the Depositary without the execution or filing of any document or any further act and, notwithstanding anything to the contrary in this Deposit Agreement, the Depositary may assign or otherwise transfer all or any of its rights and benefits under this Deposit Agreement (including any cause of action arising in connection with it) to Deutsche Bank AG or any branch thereof or any entity which is a direct or indirect subsidiary or other affiliate of Deutsche Bank AG.

**SECTION 5.5 The Custodian.** The Custodian or its successors in acting hereunder shall be subject at all times and in all respects to the direction of the Depositary for the Deposited Securities for which the Custodian acts as custodian and shall be responsible solely to it. If any Custodian resigns or is discharged from its duties hereunder with respect to any Deposited Securities and no other Custodian has previously been appointed hereunder, the Depositary shall promptly appoint a substitute custodian. The Depositary shall require such resigning or discharged Custodian to deliver the Deposited Securities held by it, together with all such records maintained by it as Custodian with respect to such Deposited Securities as the Depositary may request, to the Custodian designated by the Depositary. Whenever the Depositary determines, in its discretion, that it is appropriate to do so, it may appoint an additional entity to act as Custodian with respect to any Deposited Securities, or discharge the Custodian with respect to any Deposited Securities and appoint a substitute custodian, which shall thereafter be Custodian hereunder with respect to the Deposited Securities. After any such change, the Depositary shall give notice thereof in writing to all Holders.

Upon the appointment of any successor depositary, any Custodian then acting hereunder shall, unless otherwise instructed by the Depositary, continue to be the Custodian of the Deposited Securities without any further act or writing and shall be subject to the direction of the successor depositary. The successor depositary so appointed shall, nevertheless, on the written request of any Custodian, execute and deliver to such Custodian all such instruments as may be proper to give to such Custodian full and complete power and authority to act on the direction of such successor depositary.



SECTION 5.6 Notices and Reports. On or before the first date on which the Company gives notice, by publication or otherwise, of any meeting of holders of Shares or other Deposited Securities, or of any adjourned meeting of such holders, or of the taking of any action by such holders other than at a meeting, or of the taking of any action in respect of any cash or other distributions or the offering of any rights in respect of Deposited Securities, the Company shall transmit to the Depositary and the Custodian a copy of the notice thereof in English but otherwise in the form given or to be given to holders of Shares or other Deposited Securities. The Company shall also furnish to the Custodian and the Depositary a summary, in English, of any applicable provisions or proposed provisions of the Memorandum and Articles of Association that may be relevant or pertain to such notice of meeting or be the subject of a vote thereat.

The Company will also transmit to the Depositary (a) English language versions of the other notices, reports and communications which are made generally available by the Company to holders of its Shares or other Deposited Securities and (b) English language versions of the Company's annual and other reports prepared in accordance with the applicable requirements of the Commission. The Depositary shall arrange, at the request of the Company and at the Company's expense, for the mailing of copies thereof to all Holders, or by any other means as agreed between the Company and the Depositary (at the Company's expense) or make such notices, reports and other communications available for inspection by all Holders, provided, that, the Depositary shall have received evidence sufficiently satisfactory to it, including in the form of an Opinion of Counsel regarding U.S. law or of any other applicable jurisdiction, furnished at the expense of the Company, as the Depositary reasonably requests, that the distribution of such notices, reports and any such other communications to Holders from time to time is valid and does not or will not infringe any local, U.S. or other applicable jurisdiction regulatory restrictions or requirements if so distributed and made available to Holders. The Company will timely provide the Depositary with the quantity of such notices, reports, and communications, as requested by the Depositary from time to time, in order for the Depositary to effect such mailings. The Company has delivered to the Depositary and the Custodian a copy of the Memorandum and Articles of Association along with the provisions of or governing the Shares and any other Deposited Securities issued by the Company or any Affiliate of the Company, in connection with the Shares, in each case, to the extent not in English, along with a certified English translation thereof, and promptly upon any amendment thereto or change therein, the Company shall deliver to the Depositary and the Custodian a copy of such amendment thereto or change therein, to the extent not in English, along with a certified English translation thereof. The Depositary may rely upon such copy for all purposes of this Deposit Agreement.

The Depositary will make available, at the expense of the Company, a copy of any such notices, reports or communications issued by the Company and delivered to the Depositary for inspection by the Holders of the Receipts evidencing the American Depositary Shares representing such Shares governed by such provisions at the Depositary's Corporate Trust Office, at the office of the Custodian and at any other designated transfer office.

SECTION 5.7 Issuance of Additional Shares, ADSs etc. The Company agrees that in the event it or any of its Affiliates proposes (i) an issuance, sale or distribution of additional Shares, (ii) an offering of rights to subscribe for Shares or other Deposited Securities, (iii) an issuance of securities convertible into or exchangeable for Shares, (iv) an issuance of rights to subscribe for securities convertible into or exchangeable for Shares, (v) an elective dividend of cash or Shares, (vi) a redemption of Deposited Securities, (vii) a meeting of holders of Deposited Securities, or solicitation of consents or proxies, relating to any reclassification of securities, merger, subdivision, amalgamation or consolidation or transfer of assets, (viii) any reclassification, recapitalization, reorganization, merger, amalgamation, consolidation or sale of assets which affects the Deposited Securities or (ix) a distribution of property other than cash, Shares or rights to purchase additional Shares it will obtain U.S. legal advice and take all steps necessary to ensure that the application of the proposed transaction to Holders and Beneficial Owners does not violate the registration provisions of the Securities Act, or any other applicable laws (including, without limitation, the Investment Company Act of 1940, as amended, the Exchange Act or the securities laws of the states of the United States). In support of the foregoing, the Company will furnish to the Depositary at its request, at the Company's expense, (a) a written opinion of U.S. counsel (satisfactory to the Depositary) stating whether or not application of such transaction to Holders and Beneficial Owners (1) requires a registration statement under the Securities Act to be in effect or (2) is exempt from the registration requirements of the Securities Act and/or (3) dealing with such other issues requested by the Depositary; (b) a written opinion of Cayman Islands counsel (satisfactory to the Depositary) stating that (1) making the transaction available to Holders and Beneficial Owners does not violate the laws or regulations of the Cayman Islands and (2) all requisite regulatory and corporate consents and approvals have been obtained in the Cayman Islands; and (c) as the Depositary may request, a written Opinion of Counsel in any other jurisdiction in which Holders or Beneficial Owners reside to the effect that making the transaction available to such Holders or Beneficial Owners does not violate the laws or regulations of such jurisdiction as well as certificates of the Company as to such matters as the Depositary may deem necessary or appropriate in the circumstances. If the filing of a registration statement is required, the Depositary shall not have any obligation to proceed with the transaction unless it shall have received evidence reasonably satisfactory to it that such registration statement has been declared effective and that such distribution is in accordance with all applicable laws or regulations. If, being advised by counsel, the Company determines that a transaction is required to be registered under the Securities Act, the Company will either (i) register such transaction to the extent necessary, (ii) alter the terms of the transaction to avoid the registration requirements of the Securities Act or (iii) direct the Depositary to take specific measures, in each case as contemplated in this Deposit Agreement, to prevent such transaction from violating the registration requirements of the Securities Act.

The Company agrees with the Depositary that neither the Company nor any of its Affiliates will at any time (i) deposit any Shares or other Deposited Securities, either upon original issuance or upon a sale of Shares or other Deposited Securities previously issued and reacquired by the Company or by any such Affiliate, or (ii) issue additional Shares, rights to subscribe for such Shares, securities convertible into or exchangeable for Shares or rights to subscribe for such securities, unless such transaction and the securities issuable in such transaction are exempt from registration under the Securities Act or have been registered under the Securities Act (and such registration statement has been declared effective).

Notwithstanding anything else contained in this Deposit Agreement, nothing in this Deposit Agreement shall be deemed to obligate the Company to file any registration statement in respect of any proposed transaction.

SECTION 5.8 Indemnification. The Company agrees to indemnify the Depository, any Custodian and each of their respective directors, officers, employees, agents (including without limitation, the Agents) and Affiliates against, and hold each of them harmless from, any losses, liabilities, taxes, costs, claims, judgments, proceedings, actions, demands and any charges or expenses of any kind whatsoever (including, but not limited to, reasonable fees and expenses of counsel together with, in each case, value added tax and any similar tax charged or otherwise imposed in respect thereof) (collectively referred to as “Losses”) which the Depository or any agent (including without limitation, the Agents) thereof may incur or which may be made against it as a result of or in connection with its appointment or the exercise of its powers and duties under this Agreement or that may arise (a) out of or in connection with any offer, issuance, sale, resale, transfer, deposit or withdrawal of Receipts, American Depositary Shares, the Shares, or other Deposited Securities, as the case may be, (b) out of or in connection with any offering documents in respect thereof or (c) out of or in connection with acts performed or omitted, including, but not limited to, any delivery by the Depository on behalf of the Company of information regarding the Company in connection with this Deposit Agreement, the Receipts, the American Depositary Shares, the Shares, or any Deposited Securities, in any such case (i) by the Depository, the Custodian or any of their respective directors, officers, employees, agents (including without limitation, the Agents) and Affiliates, except to the extent any such Losses arise out of the gross negligence or wilful misconduct of any of them, or (ii) by the Company or any of its directors, officers, employees, agents and Affiliates.

The Depository agrees to indemnify the Company and hold it harmless from any Losses which may arise out of acts performed or omitted to be performed by the Depository arising out of its gross negligence or wilful misconduct. Notwithstanding the above, in no event shall the Depository or any of its directors, officers, employees, agents (including without limitation, the Agents) and/or Affiliates be liable for any special, consequential, indirect or punitive damages to the Company, Holders, Beneficial Owners or any other person.

Any person seeking indemnification hereunder (an “**Indemnified Person**”) shall notify the person from whom it is seeking indemnification (the “**Indemnifying Person**”) of the commencement of any indemnifiable action or claim promptly after such Indemnified Person becomes aware of such commencement (provided that the failure to make such notification shall not affect such Indemnified Person’s rights to indemnification except to the extent the Indemnifying Person is materially prejudiced by such failure) and shall consult in good faith with the Indemnifying Person as to the conduct of the defense of such action or claim that may give rise to an indemnity hereunder, which defense shall be reasonable under the circumstances. No Indemnified Person shall compromise or settle any action or claim that may give rise to an indemnity hereunder without the consent of the Indemnifying Person, which consent shall not be unreasonably withheld.

The obligations set forth in this Section shall survive the termination of this Deposit Agreement and the succession or substitution of any party hereto.

SECTION 5.9 Fees and Charges of Depository. The Company, the Holders, the Beneficial Owners, and persons depositing Shares or surrendering ADSs for cancellation and withdrawal of Deposited Securities shall be required to pay to the Depository the Depository’s fees and related charges identified as payable by them respectively as provided for under Article (9) of the Receipt. All fees and charges so payable may, at any time and from time to time, be changed by agreement between the Depository and the Company, but, in the case of fees and charges payable by Holders and Beneficial Owners, only in the manner contemplated in Section 6.1 hereof. The Depository shall provide, without charge, a copy of its latest fee schedule to anyone upon request.

The Depositary and the Company may reach separate agreement in relation to the payment of any additional remuneration to the Depositary in respect of any exceptional duties which the Depositary finds necessary or desirable and agreed by both parties in the performance of its obligations hereunder and in respect of the actual costs and expenses of the Depositary in respect of any notices required to be given to the Holders in accordance with Article (20) of the Receipt.

In connection with any payment by the Company to the Depositary:

- (i) all fees, taxes, duties, charges, costs and expenses which are payable by the Company shall be paid or be procured to be paid by the Company (and any such amounts which are paid by the Depositary shall be reimbursed to the Depositary by the Company upon demand therefor);
- (ii) such payment shall be subject to all necessary applicable exchange control and other consents and approvals having been obtained. The Company undertakes to use its reasonable endeavours to obtain all necessary approvals that are required to be obtained by it in this connection; and
- (iii) the Depositary may request, in its sole but reasonable discretion after reasonable consultation with the Company, an Opinion of Counsel regarding U.S. law, the laws of the Cayman Islands or of any other relevant jurisdiction, to be furnished at the expense of the Company, if at any time it deems it necessary to seek such an Opinion of Counsel regarding the validity of any action to be taken or instructed to be taken under this Agreement.

The Company agrees to promptly pay to the Depositary such other fees, charges and expenses and to reimburse the Depositary for such out-of-pocket expenses as the Depositary and the Company may agree to in writing from time to time. Responsibility for payment of such charges may at any time and from time to time be changed by agreement between the Company and the Depositary.

All payments by the Company to the Depositary under this Section 5.9 shall be paid without set-off or counterclaim, and free and clear of and without deduction or withholding for or on account of, any present or future taxes, levies, imports, duties, fees, assessments or other charges of whatever nature, imposed by the Cayman Islands or by any department, agency or other political subdivision or taxing authority thereof or therein, and all interest, penalties or similar liabilities with respect thereto.

The right of the Depositary to receive payment of fees, charges and expenses as provided above shall survive the termination of this Deposit Agreement. As to any Depositary, upon the resignation or removal of such Depositary as described in Section 5.4 hereof, such right shall extend for those fees, charges and expenses incurred prior to the effectiveness of such resignation or removal.

SECTION 5.10 Restricted Securities Owners/Ownership Restrictions. From time to time or upon request of the Depositary, the Company shall provide to the Depositary a list setting forth, to the actual knowledge of the Company, those persons or entities who beneficially own Restricted Securities and the Company shall update such list on a regular basis. The Depositary may rely on such list or update but shall not be liable for any action or omission made in reliance thereon. The Company agrees to advise in writing each of the persons or entities who, to the knowledge of the Company, holds Restricted Securities that such Restricted Securities are ineligible for deposit hereunder (except under the circumstances contemplated in Section 2.11) and, to the extent practicable, shall require each of such persons to represent in writing that such person will not deposit Restricted Securities hereunder (except under the circumstances contemplated in Section 2.11). Holders and Beneficial Owners shall comply with any limitations on ownership of Shares under the Memorandum and Articles of Association or applicable Cayman Islands law as if they held the number of Shares their ADSs represent. The Company shall, in accordance with Article (24) of the Receipt, inform Holders and Beneficial Owners and the Depositary of any other limitations on ownership of Shares that the Holders and Beneficial Owners may be subject to by reason of the number of ADSs held under the Articles of Association or applicable Cayman Islands law, as such restrictions may be in force from time to time.

The Company may, in its sole discretion, but subject to applicable law, instruct the Depositary to take action with respect to the ownership interest of any Holder or Beneficial Owner pursuant to the Memorandum and Articles of Association, including but not limited to, the removal or limitation of voting rights or the mandatory sale or disposition on behalf of a Holder or Beneficial Owner of the Shares represented by the ADRs held by such Holder or Beneficial Owner in excess of such limitations, if and to the extent such disposition is permitted by applicable law and the Memorandum and Articles of Association; provided that any such measures are practicable and legal and can be undertaken without undue burden or expense, and provided further the Depositary's agreement to the foregoing is conditional upon it being advised of any applicable changes in the Memorandum and Articles of Association. The Depositary shall have no liability for any actions taken in accordance with such instructions.

## ARTICLE VI.

### AMENDMENT AND TERMINATION

SECTION 6.1 Amendment/Supplement. Subject to the terms and conditions of this Section 6.1 and applicable law, the Receipts outstanding at any time, the provisions of this Deposit Agreement and the form of Receipt attached hereto and to be issued under the terms hereof may at any time and from time to time be amended or supplemented by written agreement between the Company and the Depository in any respect which they may deem necessary or desirable and not materially prejudicial to the Holders without the consent of the Holders or Beneficial Owners. Any amendment or supplement which shall impose or increase any fees or charges (other than charges in connection with foreign exchange control regulations, and taxes and/or other governmental charges, delivery and other such expenses payable by Holders or Beneficial Owners), or which shall otherwise materially prejudice any substantial existing right of Holders or Beneficial Owners, shall not, however, become effective as to outstanding Receipts until 30 days after notice of such amendment or supplement shall have been given to the Holders of outstanding Receipts. Notice of any amendment to this Deposit Agreement or form of Receipts shall not need to describe in detail the specific amendments effectuated thereby, and failure to describe the specific amendments in any such notice shall not render such notice invalid, provided, however, that, in each such case, the notice given to the Holders identifies a means for Holders and Beneficial Owners to retrieve or receive the text of such amendment (e., upon retrieval from the Commission's, the Depository's or the Company's website or upon request from the Depository). The parties hereto agree that any amendments or supplements which (i) are reasonably necessary (as agreed by the Company and the Depository) in order for (a) the American Depository Shares to be registered on Form F-6 under the Securities Act or (b) the American Depository Shares or the Shares to be traded solely in electronic book-entry form and (ii) do not in either such case impose or increase any fees or charges to be borne by Holders, shall be deemed not to materially prejudice any substantial rights of Holders or Beneficial Owners. Every Holder and Beneficial Owner at the time any amendment or supplement so becomes effective shall be deemed, by continuing to hold such American Depository Share or Shares, to consent and agree to such amendment or supplement and to be bound by this Deposit Agreement as amended and supplemented thereby. In no event shall any amendment or supplement impair the right of the Holder to surrender such Receipt and receive therefor the Deposited Securities represented thereby, except in order to comply with mandatory provisions of applicable law. Notwithstanding the foregoing, if any governmental body should adopt new laws, rules or regulations which would require amendment or supplement of this Deposit Agreement to ensure compliance therewith, the Company and the Depository may amend or supplement this Deposit Agreement and the Receipt at any time in accordance with such changed laws, rules or regulations. Such amendment or supplement to this Deposit Agreement in such circumstances may become effective before a notice of such amendment or supplement is given to Holders or within any other period of time as required for compliance with such laws, rules or regulations.

**SECTION 6.2 Termination.** The Depository shall, at any time at the written direction of the Company, terminate this Deposit Agreement by mailing notice of such termination to the Holders of all Receipts then outstanding at least 90 days prior to the date fixed in such notice for such termination, provided that, the Depository shall be reimbursed for any amounts, fees, costs or expenses owed to it in accordance with the terms of this Deposit Agreement and in accordance with any other agreements as otherwise agreed in writing between the Company and the Depository from time to time, prior to such termination shall take effect. If 90 days shall have expired after (i) the Depository shall have delivered to the Company a written notice of its election to resign, or (ii) the Company shall have delivered to the Depository a written notice of the removal of the Depository, and in either case a successor depository shall not have been appointed and accepted its appointment as provided in Section 5.4 hereof, the Depository may terminate this Deposit Agreement by mailing notice of such termination to the Holders of all Receipts then outstanding at least 30 days prior to the date fixed for such termination. On and after the date of termination of this Deposit Agreement, each Holder will, upon surrender of such Receipt at the Corporate Trust Office of the Depository, upon the payment of the charges of the Depository for the surrender of Receipts referred to in Section 2.6 hereof and subject to the conditions and restrictions therein set forth, and upon payment of any applicable taxes and/or governmental charges, be entitled to Delivery, to him or upon his order, of the amount of Deposited Securities represented by such Receipt. If any Receipts shall remain outstanding after the date of termination of this Deposit Agreement, the Registrar thereafter shall discontinue the registration of transfers of Receipts, and the Depository shall suspend the distribution of dividends to the Holders thereof, and shall not give any further notices or perform any further acts under this Deposit Agreement, except that the Depository shall continue to collect dividends and other distributions pertaining to Deposited Securities, shall sell rights or other property as provided in this Deposit Agreement, and shall continue to Deliver Deposited Securities, subject to the conditions and restrictions set forth in Section 2.6 hereof, together with any dividends or other distributions received with respect thereto and the net proceeds of the sale of any rights or other property, in exchange for Receipts surrendered to the Depository (after deducting, or charging, as the case may be, in each case, the charges of the Depository for the surrender of a Receipt, any expenses for the account of the Holder in accordance with the terms and conditions of this Deposit Agreement and any applicable taxes and/or governmental charges or assessments). At any time after the expiration of six months from the date of termination of this Deposit Agreement, the Depository may sell the Deposited Securities then held hereunder and may thereafter hold uninvested the net proceeds of any such sale, together with any other cash then held by it hereunder, in an unsegregated account, without liability for interest for the pro rata benefit of the Holders of Receipts whose Receipts have not theretofore been surrendered. After making such sale, the Depository shall be discharged from all obligations under this Deposit Agreement with respect to the Receipts and the Shares, Deposited Securities and American Depositary Shares, except to account for such net proceeds and other cash (after deducting, or charging, as the case may be, in each case, the charges of the Depository for the surrender of a Receipt, any expenses for the account of the Holder in accordance with the terms and conditions of this Deposit Agreement and any applicable taxes and/or governmental charges or assessments). Upon the termination of this Deposit Agreement, the Company shall be discharged from all obligations under this Deposit Agreement except for its obligations to the Depository hereunder. The obligations under the terms of this Deposit Agreement and Receipts of Holders and Beneficial Owners of ADSs outstanding as of the effective date of any termination shall survive such effective date of termination and shall be discharged only when the applicable ADSs are presented by their Holders to the Depository for cancellation under the terms of this Deposit Agreement and the Holders have each satisfied any and all of their obligations hereunder (including, but not limited to, any payment and/or reimbursement obligations which relate to prior to the effective date of termination but which payment and/or reimbursement is claimed after such effective date of termination).

Notwithstanding anything contained in this Deposit Agreement or any ADR, in connection with the termination of this Deposit Agreement, the Depository may, independently and without the need for any action by the Company, make available to Holders of ADSs a means to withdraw the Deposited Securities represented by their ADSs and to direct the deposit of such Deposited Securities into an unsponsored American depository shares program established by the Depository, upon such terms and conditions as the Depository may deem reasonably appropriate, subject however, in each case, to satisfaction of the applicable registration requirements by the unsponsored American depository shares program under the Securities Act, and to receipt by the Depository of payment of the applicable fees and charges of, and reimbursement of the applicable expenses incurred by, the Depository.

## ARTICLE VII.

### MISCELLANEOUS

SECTION 7.1 Counterparts. This Deposit Agreement may be executed in any number of counterparts, each of which shall be deemed an original, and all of such counterparts together shall constitute one and the same agreement. Copies of this Deposit Agreement shall be maintained with the Depository and shall be open to inspection by any Holder during business hours.

SECTION 7.2 No Third-Party Beneficiaries. This Deposit Agreement is for the exclusive benefit of the parties hereto (and their successors) and shall not be deemed to give any legal or equitable right, remedy or claim whatsoever to any other person, except to the extent specifically set forth in this Deposit Agreement. Nothing in this Deposit Agreement shall be deemed to give rise to a partnership or joint venture among the parties hereto nor establish a fiduciary or similar relationship among the parties. The parties hereto acknowledge and agree that (i) the Depository and its Affiliates may at any time have multiple banking relationships with the Company and its Affiliates, (ii) the Depository and its Affiliates may be engaged at any time in transactions in which parties adverse to the Company or the Holders or Beneficial Owners may have interests and (iii) nothing contained in this Agreement shall (a) preclude the Depository or any of its Affiliates from engaging in such transactions or establishing or maintaining such relationships, or (b) obligate the Depository or any of its Affiliates to disclose such transactions or relationships or to account for any profit made or payment received in such transactions or relationships.

SECTION 7.3 Severability. In case any one or more of the provisions contained in this Deposit Agreement or in the Receipts should be or become invalid, illegal or unenforceable in any respect, the validity, legality and enforceability of the remaining provisions contained herein or therein shall in no way be affected, prejudiced or disturbed thereby.

SECTION 7.4 Holders and Beneficial Owners as Parties; Binding Effect. The Holders and Beneficial Owners from time to time of American Depositary Shares shall be parties to this Deposit Agreement and shall be bound by all of the terms and conditions hereof and of any Receipt by acceptance hereof or any beneficial interest therein.

SECTION 7.5 Notices. Any and all notices to be given to the Company shall be deemed to have been duly given if personally delivered or sent by first-class mail, air courier or cable, telex, facsimile transmission or electronic transmission, confirmed by letter, addressed to 5820 Oberlin Drive, Suite 101, San Diego, CA 92121, USA, Attention: Hao-Yuan Chuang, telephone: +886-910-918-513, email: hyc@belitebio.com, or to any other address which the Company may specify in writing to the Depository or at which it may be effectively given such notice in accordance with applicable law.

Any and all notices to be given to the Depository shall be deemed to have been duly given if personally delivered or sent by first-class mail, air courier or cable, telex, facsimile transmission or by electronic transmission (if agreed by the Company and the Depository), at the Company's expense, unless otherwise agreed in writing between the Company and the Depository, confirmed by letter, addressed to Deutsche Bank Trust Company Americas, 1 Columbus Circle, New York, New York 10019, USA, Attention: ADR Department, telephone: +1 212 250-9100, facsimile: +1 212 797 0327 or to any other address which the Depository may specify in writing to the Company.

Any and all notices to be given to any Holder shall be deemed to have been duly given if personally delivered or sent by first-class mail or cable, telex, facsimile transmission or by electronic transmission (if agreed by the Company and the Depository), at the Company's expense, unless otherwise agreed in writing between the Company and the Depository, addressed to such Holder at the address of such Holder as it appears on the transfer books for Receipts of the Depository, or, if such Holder shall have filed with the Depository a written request that notices intended for such Holder be mailed to some other address, at the address specified in such request. Notice to Holders shall be deemed to be notice to Beneficial Owners for all purposes of this Deposit Agreement.

Delivery of a notice sent by mail, air courier or cable, telex, facsimile or electronic transmission shall be deemed to be effective at the time when a duly addressed letter containing the same (or a confirmation thereof in the case of a cable, telex, facsimile or electronic transmission) is deposited, postage prepaid, in a post-office letter box or delivered to an air courier service. The Depository or the Company may, however, act upon any cable, telex, facsimile or electronic transmission received by it from the other or from any Holder, notwithstanding that such cable, telex, facsimile or electronic transmission shall not subsequently be confirmed by letter as aforesaid, as the case may be.



**SECTION 7.6 Governing Law and Jurisdiction.** This Deposit Agreement and the Receipts shall be interpreted in accordance with, and all rights hereunder and thereunder and provisions hereof and thereof shall be governed by, the laws of the State of New York without reference to the principles of choice of law thereof. Subject to the Depository's rights under the third paragraph of this Section 7.6, the Company and the Depository agree that the federal or state courts in the City of New York shall have exclusive jurisdiction to hear and determine any suit, action or proceeding and to settle any dispute between them that may arise out of or in connection with this Deposit Agreement and, for such purposes, each irrevocably submits to the exclusive jurisdiction of such courts. Notwithstanding the above, the parties hereto agree that any judgment and/or order from any such New York court can be enforced in any court having jurisdiction thereof. The Company hereby irrevocably designates, appoints and empowers Puglisi & Associates, (the "**Process Agent**"), now at 850 Library Avenue, Suite 204, Newark, Delaware 19711, USA, as its authorized agent to receive and accept for and on its behalf, and on behalf of its properties, assets and revenues, service by mail of any and all legal process, summons, notices and documents that may be served in any suit, action or proceeding brought against the Company in any federal or state court as described in the preceding sentence or in the next paragraph of this Section 7.6. If for any reason the Process Agent shall cease to be available to act as such, the Company agrees to designate a new agent in the City of New York on the terms and for the purposes of this Section 7.6 reasonably satisfactory to the Depository. The Company further hereby irrevocably consents and agrees to the service of any and all legal process, summons, notices and documents in any suit, action or proceeding against the Company, by service by mail of a copy thereof upon the Process Agent (whether or not the appointment of such Process Agent shall for any reason prove to be ineffective or such Process Agent shall fail to accept or acknowledge such service), with a copy mailed to the Company by registered or certified air mail, postage prepaid, to its address provided in Section 7.5 hereof. The Company agrees that the failure of the Process Agent to give any notice of such service to it shall not impair or affect in any way the validity of such service or any judgment rendered in any action or proceeding based thereon.

The Company irrevocably and unconditionally waives, to the fullest extent permitted by law, any objection that it may now or hereafter have to the laying of venue of any actions, suits or proceedings brought in any court as provided in this Section 7.6, and hereby further irrevocably and unconditionally waives and agrees not to plead or claim in any such court that any such action, suit or proceeding brought in any such court has been brought in an inconvenient forum.

The Company, the Depository and by holding an American Depositary Share (or interest therein) Holders and Beneficial Owners each agree that, notwithstanding the foregoing, with regard to any claim or dispute or difference of whatever nature between or involving the parties hereto arising directly or indirectly from the relationship created by this Deposit Agreement, the Depository, in its sole discretion, shall be entitled to refer such dispute or difference for final settlement by arbitration (“**Arbitration**”) in accordance with the Commercial Arbitration Rules of the American Arbitration Association (the “**Rules**”) then in force. The arbitration shall be conducted by three arbitrators, one nominated by the Depository, one nominated by the Company, and one nominated by the two party-appointed arbitrators within 30 calendar days of the confirmation of the nomination of the second arbitrator. If any arbitrator has not been nominated within the time limits specified herein and in the Rules, then such arbitrator shall be appointed by the American Arbitration Association in accordance with the Rules. Judgment upon the award rendered by the arbitrators may be enforced in any court having jurisdiction thereof. The seat and place of any reference to arbitration shall be New York City, New York, and the procedural law of such arbitration shall be New York law. The language to be used in the arbitration shall be English. The fees of the arbitrator and other costs incurred by the parties in connection with such Arbitration shall be paid by the party or parties that is (are) unsuccessful in such Arbitration. For the avoidance of doubt this paragraph does not preclude Holders and Beneficial Owners from pursuing claims under the Securities Act or the Exchange Act in federal courts.

Holders and Beneficial Owners understand, and holding an American Depositary Share or an interest therein, such Holders and Beneficial Owners each irrevocably agree that any legal suit, action or proceeding against or involving the Company or the Depository, arising out of or based upon the Deposit Agreement, the American Depositary Shares or Receipts, or the transactions contemplated hereby or thereby or by virtue of ownership thereof, may only be instituted in a state or federal court in New York, New York, and by holding an American Depositary Share or an interest therein each irrevocably waives any objection which it may now or hereafter have to the laying of venue of any such proceeding, and irrevocably submits to the exclusive jurisdiction of such courts in any such suit, action or proceeding. Holders and Beneficial Owners agree that the provisions of this paragraph shall survive such Holders’ and Beneficial Owners’ ownership of American Depositary Shares or interests therein.

EACH PARTY TO THIS DEPOSIT AGREEMENT (INCLUDING, FOR AVOIDANCE OF DOUBT, EACH HOLDER AND BENEFICIAL OWNER AND/OR HOLDER OF INTERESTS IN ANY ADRs) HEREBY IRREVOCABLY WAIVES, TO THE FULLEST EXTENT PERMITTED BY APPLICABLE LAW, ANY RIGHT IT MAY HAVE TO A TRIAL BY JURY IN ANY SUIT, ACTION OR PROCEEDING AGAINST THE DEPOSITARY AND/OR THE COMPANY DIRECTLY OR INDIRECTLY ARISING OUT OF OR RELATING TO THE SHARES OR OTHER DEPOSITED SECURITIES, THE ADSs OR THE ADRs, THIS DEPOSIT AGREEMENT OR ANY TRANSACTION CONTEMPLATED HEREIN OR THEREIN, OR THE BREACH HEREOF OR THEREOF (WHETHER BASED ON CONTRACT, TORT, COMMON LAW OR ANY OTHER THEORY).

The provisions of this Section 7.6 shall survive any termination of this Deposit Agreement, in whole or in part.

SECTION 7.7 Assignment. Subject to the provisions and exceptions set forth in Section 5.4 hereof, this Deposit Agreement may not be assigned by either the Company or the Depository.

SECTION 7.8 Agents. The Depository shall be entitled, in its sole but reasonable discretion, to appoint one or more agents (the “**Agents**”) of which it shall have control for the purpose, *inter alia*, of making distributions to the Holders or otherwise carrying out its obligations under this Agreement.

SECTION 7.9 Affiliates etc. The Depositary reserves the right to utilize and retain a division or Affiliate(s) of the Depositary to direct, manage and/or execute any public and/or private sale of Shares, rights, securities, property or other entitlements hereunder and to engage in the conversion of Foreign Currency hereunder. It is anticipated that such division and/or Affiliate(s) will charge the Depositary a fee and/or commission in connection with each such transaction, and seek reimbursement of its costs and expenses related thereto. Such fees/commissions, costs and expenses, shall be deducted from amounts distributed hereunder and shall not be deemed to be fees of the Depositary under Article (9) of the Receipt or otherwise. Persons are advised that in converting foreign currency into U.S. dollars the Depositary may utilize Deutsche Bank AG or its affiliates (collectively, “DBAG”) to effect such conversion by seeking to enter into a foreign exchange (“FX”) transaction with DBAG. When converting currency, the Depositary is not acting as a fiduciary for the holders or beneficial owners of depositary receipts or any other person. Moreover, in executing FX transactions, DBAG will be acting in a principal capacity, and not as agent, fiduciary or broker, and may hold positions for its own account that are the same, similar, different or opposite to the positions of its customers, including the Depositary. When the Depositary seeks to execute an FX transaction to accomplish such conversion, customers should be aware that DBAG is a global dealer in FX for a full range of FX products and, as a result, the rate obtained in connection with any requested foreign currency conversion may be impacted by DBAG executing FX transactions for its own account or with another customer. In addition, in order to source liquidity for any FX transaction relating to any foreign currency conversion, DBAG may internally share economic terms relating to the relevant FX transaction with persons acting in a sales or trading capacity for DBAG or one of its agents. DBAG may charge fees and/or commissions to the Depositary or add a mark-up in connection with such conversions, which are reflected in the rate at which the foreign currency will be converted into U.S. dollars. The Depositary, its Affiliates and their agents, on their own behalf, may own and deal in any class of securities of the Company and its Affiliates and in ADSs.

SECTION 7.10 Exclusivity. The Company agrees not to appoint any other depositary for the issuance or administration of depositary receipts evidencing any class of stock of the Company so long as Deutsche Bank Trust Company Americas is acting as Depositary hereunder.

SECTION 7.11 Compliance with U.S. Securities Laws. Notwithstanding anything in this Deposit Agreement to the contrary, the withdrawal or Delivery of Deposited Securities will not be suspended by the Company or the Depositary except as would be permitted by Instruction I.A.(1) of the General Instructions to Form F-6 Registration Statement, as amended from time to time, under the Securities Act.

SECTION 7.12 Titles. All references in this Deposit Agreement to exhibits, Articles, sections, subsections, and other subdivisions refer to the exhibits, Articles, sections, subsections and other subdivisions of this Deposit Agreement unless expressly provided otherwise. The words “**this Deposit Agreement**”, “**herein**”, “**hereof**”, “**hereby**”, “**hereunder**”, and words of similar import refer to this Deposit Agreement as a whole as in effect between the Company, the Depositary and the Holders and Beneficial Owners of ADSs and not to any particular subdivision unless expressly so limited. Pronouns in masculine, feminine and neuter gender shall be construed to include any other gender, and words in the singular form shall be construed to include the plural and vice versa unless the context otherwise requires. Titles to sections of this Deposit Agreement are included for convenience only and shall be disregarded in construing the language contained in this Deposit Agreement.

IN WITNESS WHEREOF, BELITE BIO, INC and DEUTSCHE BANK TRUST COMPANY AMERICAS have duly executed this Deposit Agreement as of the day and year first above set forth and all Holders and Beneficial Owners shall become parties hereto upon acceptance by them of American Depositary Shares evidenced by Receipts issued in accordance with the terms hereof.

**BELITE BIO, INC**

By: \_\_\_\_\_  
Name:  
Title:

**DEUTSCHE BANK TRUST COMPANY AMERICAS**

By: \_\_\_\_\_  
Name:  
Title:

By: \_\_\_\_\_  
Name:  
Title:

CUSIP \_\_\_\_\_

ISIN \_\_\_\_\_

American Depositary  
Shares (Each  
American Depositary  
Share  
representing [●]  
Fully Paid Ordinary  
Shares)

**[FORM OF FACE OF RECEIPT]**

## AMERICAN DEPOSITARY RECEIPT

for

AMERICAN DEPOSITARY SHARES

representing

DEPOSITED ORDINARY SHARES

of

BELITE BIO, INC

(Incorporated under the laws of the Cayman Islands)

DEUTSCHE BANK TRUST COMPANY AMERICAS, as depositary (herein called the “**Depositary**”), hereby certifies that \_\_\_\_\_ is the owner of \_\_\_\_\_ American Depositary Shares (hereinafter “**ADS**”), representing deposited ordinary shares, each of Par Value of U.S. \$ 0.0001 including evidence of rights to receive such ordinary shares (the “**Shares**”) of Belite Bio, Inc, a company incorporated under the laws of the Cayman Islands (the “**Company**”). As of the date of the Deposit Agreement (hereinafter referred to), each ADS represents [●] Shares deposited under the Deposit Agreement with the Custodian which at the date of execution of the Deposit Agreement is Deutsche Bank AG, Hong Kong Branch (the “**Custodian**”). The ratio of Depositary Shares to shares of stock is subject to subsequent amendment as provided in Article IV of the Deposit Agreement. The Depositary’s Corporate Trust Office is located at 1 Columbus Circle, New York, New York 10019, U.S.A.

(1) The Deposit Agreement. This American Depositary Receipt is one of an issue of American Depositary Receipts (“**Receipts**”), all issued or to be issued upon the terms and conditions set forth in the Deposit Agreement, dated as of [●], 2022 (as amended from time to time, the “**Deposit Agreement**”), by and among the Company, the Depositary, and all Holders and Beneficial Owners from time to time of Receipts issued thereunder, each of whom by accepting a Receipt agrees to become a party thereto and becomes bound by all the terms and conditions thereof. The Deposit Agreement sets forth the rights and obligations of Holders and Beneficial Owners of Receipts and the rights and duties of the Depositary in respect of the Shares deposited thereunder and any and all other securities, property and cash from time to time, received in respect of such Shares and held thereunder (such Shares, other securities, property and cash are herein called “**Deposited Securities**”). Copies of the Deposit Agreement are on file at the Corporate Trust Office of the Depositary and the Custodian.

Each owner and each Beneficial Owner, upon acceptance of any ADSs (or any interest therein) issued in accordance with the terms and conditions of the Deposit Agreement, shall be deemed for all purposes to (a) be a party to and bound by the terms of the Deposit Agreement and applicable ADR(s), and (b) appoint the Depository its attorney-in-fact, with full power to delegate, to act on its behalf and to take any and all actions contemplated in the Deposit Agreement and the applicable ADR(s), to adopt any and all procedures necessary to comply with applicable law and to take such action as the Depository in its sole discretion may deem necessary or appropriate to carry out the purposes of the Deposit Agreement and the applicable ADR(s) (the taking of such actions to be the conclusive determinant of the necessity and appropriateness thereof).

The statements made on the face and reverse of this Receipt are summaries of certain provisions of the Deposit Agreement and the Memorandum and Articles of Association (as in effect on the date of the Deposit Agreement) and are qualified by and subject to the detailed provisions of the Deposit Agreement, to which reference is hereby made. All capitalized terms used herein which are not otherwise defined herein shall have the meanings ascribed thereto in the Deposit Agreement. To the extent there is any inconsistency between the terms of this Receipt and the terms of the Deposit Agreement, the terms of the Deposit Agreement shall prevail. Prospective and actual Holders and Beneficial Owners are encouraged to read the terms of the Deposit Agreement. The Depository makes no representation or warranty as to the validity or worth of the Deposited Securities. The Depository has made arrangements for the acceptance of the American Depositary Shares into DTC. Each Beneficial Owner of American Depositary Shares held through DTC must rely on the procedures of DTC and the DTC Participants to exercise and be entitled to any rights attributable to such American Depositary Shares. The Receipt evidencing the American Depositary Shares held through DTC will be registered in the name of a nominee of DTC. So long as the American Depositary Shares are held through DTC or unless otherwise required by law, ownership of beneficial interests in the Receipt registered in the name of DTC (or its nominee) will be shown on, and transfers of such ownership will be effected only through, records maintained by (i) DTC (or its nominee), or (ii) DTC Participants (or their nominees).

(2) Surrender of Receipts and Withdrawal of Deposited Securities. Upon surrender, at the Corporate Trust Office of the Depository, of ADSs evidenced by this Receipt for the purpose of withdrawal of the Deposited Securities represented thereby, and upon payment of (i) the fees and charges of the Depository for the making of withdrawals of Deposited Securities and cancellation of Receipts (as set forth in Section 5.9 of the Deposit Agreement and Article (9) hereof) and (ii) all fees, taxes and/or governmental charges payable in connection with such surrender and withdrawal, and, subject to the terms and conditions of the Deposit Agreement, the Memorandum and Articles of Association, Section 7.11 of the Deposit Agreement, Article (22) hereof and the provisions of or governing the Deposited Securities and other applicable laws, the Holder of the American Depositary Shares evidenced hereby is entitled to Delivery, to him or upon his order, of the Deposited Securities represented by the ADS so surrendered. ADS may be surrendered for the purpose of withdrawing Deposited Securities by Delivery of a Receipt evidencing such ADS (if held in registered form) or by book-entry delivery of such ADS to the Depository.

A Receipt surrendered for such purposes shall, if so required by the Depositary, be properly endorsed in blank or accompanied by proper instruments of transfer in blank, and if the Depositary so requires, the Holder thereof shall execute and deliver to the Depositary a written order directing the Depositary to cause the Deposited Securities being withdrawn to be Delivered to or upon the written order of a person or persons designated in such order. Thereupon, the Depositary shall direct the Custodian to Deliver (without unreasonable delay) at the designated office of the Custodian or through a book-entry delivery of the Shares (in either case subject to the terms and conditions of the Deposit Agreement, to the Memorandum and Articles of Association, and to the provisions of or governing the Deposited Securities and applicable laws, now or hereafter in effect), to or upon the written order of the person or persons designated in the order delivered to the Depositary as provided above, the Deposited Securities represented by such ADSs, together with any certificate or other proper documents of or relating to title for the Deposited Securities or evidence of the electronic transfer thereof (if available) as the case may be to or for the account of such person. Subject to Article (4) hereof, in the case of surrender of a Receipt evidencing a number of ADSs representing other than a whole number of Shares, the Depositary shall cause ownership of the appropriate whole number of Shares to be Delivered in accordance with the terms hereof, and shall, at the discretion of the Depositary, either (i) issue and Deliver to the person surrendering such Receipt a new Receipt evidencing American Depositary Shares representing any remaining fractional Share, or (ii) sell or cause to be sold the fractional Shares represented by the Receipt so surrendered and remit the proceeds thereof (net of (a) applicable fees and charges of, and expenses incurred by, the Depositary and/or a division or Affiliate(s) of the Depositary and (b) taxes and/or governmental charges) to the person surrendering the Receipt. At the request, risk and expense of any Holder so surrendering a Receipt, and for the account of such Holder, the Depositary shall direct the Custodian to forward (to the extent permitted by law) any cash or other property (other than securities) held in respect of, and any certificate or certificates and other proper documents of or relating to title to, the Deposited Securities represented by such Receipt to the Depositary for Delivery at the Corporate Trust Office of the Depositary, and for further Delivery to such Holder. Such direction shall be given by letter or, at the request, risk and expense of such Holder, by cable, telex or facsimile transmission. Upon receipt of such direction by the Depositary, the Depositary may make delivery to such person or persons entitled thereto at the Corporate Trust Office of the Depositary of any dividends or cash distributions with respect to the Deposited Securities represented by such Receipt, or of any proceeds of sale of any dividends, distributions or rights, which may at the time be held by the Depositary.

(3) Transfers, Split-Ups and Combinations of Receipts. Subject to the terms and conditions of the Deposit Agreement, the Registrar shall register transfers of Receipts on its books, upon surrender at the Corporate Trust Office of the Depositary of a Receipt by the Holder thereof in person or by duly authorized attorney, properly endorsed in the case of a certificated Receipt or accompanied by, or in the case of Receipts issued through any book-entry system, including, without limitation, DRS/Profile, receipt by the Depositary of proper instruments of transfer (including signature guarantees in accordance with standard industry practice) and duly stamped as may be required by the laws of the State of New York, of the United States, of the Cayman Islands and of any other applicable jurisdiction. Subject to the terms and conditions of the Deposit Agreement, including payment of the applicable fees and expenses incurred by, and charges of, the Depositary, the Depositary shall execute and Deliver a new Receipt(s) (and if necessary, cause the Registrar to countersign such Receipt(s)) and deliver same to or upon the order of the person entitled to such Receipts evidencing the same aggregate number of ADSs as those evidenced by the Receipts surrendered. Upon surrender of a Receipt or Receipts for the purpose of effecting a split-up or combination of such Receipt or Receipts upon payment of the applicable fees and charges of the Depositary, and subject to the terms and conditions of the Deposit Agreement, the Depositary shall execute and deliver a new Receipt or Receipts for any authorized number of ADSs requested, evidencing the same aggregate number of ADSs as the Receipt or Receipts surrendered.

(4) Pre-Conditions to Registration, Transfer, Etc. As a condition precedent to the execution and Delivery, registration, registration of transfer, split-up, subdivision, combination or surrender of any Receipt, the delivery of any distribution thereon (whether in cash or shares) or withdrawal of any Deposited Securities, the Depositary or the Custodian may require (i) payment from the depositor of Shares or presenter of the Receipt of a sum sufficient to reimburse it for any tax or other governmental charge and any stock transfer or registration fee with respect thereto (including any such tax or charge and fee with respect to Shares being deposited or withdrawn) and payment of any applicable fees and charges of the Depositary as provided in the Deposit Agreement and in this Receipt, (ii) the production of proof satisfactory to it as to the identity and genuineness of any signature or any other matter and (iii) compliance with (A) any laws or governmental regulations relating to the execution and Delivery of Receipts and ADSs or to the withdrawal of Deposited Securities and (B) such reasonable regulations of the Depositary or the Company consistent with the Deposit Agreement and applicable law.

The issuance of ADSs against deposits of Shares generally or against deposits of particular Shares may be suspended, or the issuance of ADSs against the deposit of particular Shares may be withheld, or the registration of transfer of Receipts in particular instances may be refused, or the registration of transfer of Receipts generally may be suspended, during any period when the transfer books of the Depositary are closed or if any such action is deemed necessary or advisable by the Depositary or the Company, in good faith, at any time or from time to time because of any requirement of law, any government or governmental body or commission or any securities exchange upon which the Receipts or Share are listed, or under any provision of the Deposit Agreement or provisions of, or governing, the Deposited Securities or any meeting of shareholders of the Company or for any other reason, subject in all cases to Article (22) hereof.

The Depositary shall not issue ADSs prior to the receipt of Shares or deliver Shares prior to the receipt and cancellation of ADSs.

(5) Compliance With Information Requests. Notwithstanding any other provision of the Deposit Agreement or this Receipt, each Holder and Beneficial Owner of the ADSs represented hereby agrees to comply with requests from the Company pursuant to the laws of the Cayman Islands, the rules and requirements of the New York Stock Exchange and any other stock exchange on which the Shares are, or will be registered, traded or listed, the Memorandum and Articles of Association, which are made to provide information as to the capacity in which such Holder or Beneficial Owner owns ADSs and regarding the identity of any other person interested in such ADSs and the nature of such interest and various other matters whether or not they are Holders and/or Beneficial Owner at the time of such request. The Depositary agrees to use reasonable efforts to forward any such requests to the Holders and to forward to the Company any such responses to such requests received by the Depositary.



(6) Liability of Holder for Taxes, Duties and Other Charges. If any tax or other governmental charge shall become payable by the Depositary or the Custodian with respect to any Receipt or any Deposited Securities or ADSs, such tax or other governmental charge shall be payable by the Holders and Beneficial Owners to the Depositary. The Company, the Custodian and/or the Depositary may withhold or deduct from any distributions made in respect of Deposited Securities and may sell for the account of the Holder and/or Beneficial Owner any or all of the Deposited Securities and apply such distributions and sale proceeds in payment of such taxes (including applicable interest and penalties) or charges, with the Holder and the Beneficial Owner hereof remaining fully liable for any deficiency. The Custodian may refuse the deposit of Shares, and the Depositary may refuse to issue ADSs, to deliver Receipts, register the transfer, split-up or combination of ADRs and (subject to Article (22) hereof) the withdrawal of Deposited Securities, until payment in full of such tax, charge, penalty or interest is received.

The liability of Holders and Beneficial Owners under the Deposit Agreement shall survive any transfer of Receipts, any surrender of Receipts and withdrawal of Deposited Securities or the termination of the Deposit Agreement.

Holders understand that in converting Foreign Currency, amounts received on conversion are calculated at a rate which may exceed the number of decimal places used by the Depositary to report distribution rates (which in any case will not be less than two decimal places). Any excess amount may be retained by the Depositary as an additional cost of conversion, irrespective of any other fees and expenses payable or owing hereunder and shall not be subject to escheatment.

(7) Representations and Warranties of Depositors. Each person depositing Shares under the Deposit Agreement shall be deemed thereby to represent and warrant that (i) such Shares (and the certificates therefor) are duly authorized, validly issued, fully paid, non-assessable and were legally obtained by such person, (ii) all preemptive (and similar) rights, if any, with respect to such Shares, have been validly waived or exercised, (iii) the person making such deposit is duly authorized so to do, (iv) the Shares presented for deposit are free and clear of any lien, encumbrance, security interest, charge, mortgage or adverse claim, and are not, and the ADSs issuable upon such deposit will not be, Restricted Securities (except as contemplated by Section 2.11 of the Deposit Agreement), (v) the Shares presented for deposit have not been stripped of any rights or entitlements and (vi) the Shares are not subject to any lock-up agreement with the Company or other party, or the Shares are subject to a lock-up agreement but such lock-up agreement has terminated or the lock-up restrictions imposed thereunder have expired or been validly waived. Such representations and warranties shall survive the deposit and withdrawal of Shares and the issuance, cancellation and transfer of ADSs. If any such representations or warranties are false in any way, the Company and Depositary shall be authorized, at the cost and expense of the person depositing Shares, to take any and all actions necessary to correct the consequences thereof.

(8) Filing Proofs, Certificates and Other Information. Any person presenting Shares for deposit shall provide, any Holder and any Beneficial Owner may be required to provide, and every Holder and Beneficial Owner agrees, from time to time to provide to the Depository such proof of citizenship or residence, taxpayer status, payment of all applicable taxes and/or other governmental charges, exchange control approval, legal or beneficial ownership of ADSs and Deposited Securities, compliance with applicable laws and the terms of the Deposit Agreement and the provisions of, or governing, the Deposited Securities or other information as the Depository deems necessary or proper or as the Company may reasonably require by written request to the Depository consistent with its obligations under the Deposit Agreement. Pursuant to the Deposit Agreement, the Depository and the Registrar, as applicable, may withhold the execution or Delivery or registration of transfer of any Receipt or the distribution or sale of any dividend or other distribution of rights or of the proceeds thereof, or to the extent not limited by the terms of Article (22) hereof or the terms of the Deposit Agreement, the Delivery of any Deposited Securities until such proof or other information is filed or such certifications are executed, or such representations and warranties are made, or such other documentation or information provided, in each case to the Depository's and the Company's satisfaction. The Depository shall from time to time on the written request of the Company advise the Company of the availability of any such proofs, certificates or other information and shall, at the Company's sole expense, provide or otherwise make available copies thereof to the Company upon written request therefor by the Company, unless such disclosure is prohibited by law. Each Holder and Beneficial Owner agrees to provide any information requested by the Company or the Depository pursuant to this paragraph. Nothing herein shall obligate the Depository to (i) obtain any information for the Company if not provided by the Holders or Beneficial Owners or (ii) verify or vouch for the accuracy of the information so provided by the Holders or Beneficial Owners.

Every Holder and Beneficial Owner agrees to indemnify the Depository, the Company, the Custodian, the Agents and each of their respective directors, officers, employees, agents and Affiliates against, and to hold each of them harmless from, any Losses which any of them may incur or which may be made against any of them as a result of or in connection with any inaccuracy in or omission from any such proof, certificate, representation, warranty, information or document furnished by or on behalf of such Holder and/or Beneficial Owner or as a result of any such failure to furnish any of the foregoing.

The obligations of Holders and Beneficial Owners under the Deposit Agreement shall survive any transfer of Receipts, any surrender of Receipts and withdrawal of Deposited Securities or the termination of the Deposit Agreement.

(9) Charges of Depository. The Depository reserves the right to charge the following fees for the services performed under the terms of the Deposit Agreement, provided, however, that no fees shall be payable upon distribution of cash dividends so long as the charging of such fee is prohibited by the exchange, if any, upon which the ADSs are listed:

- (i) to any person to whom ADSs are issued or to any person to whom a distribution is made in respect of ADS distributions pursuant to stock dividends or other free distributions of stock, bonus distributions, stock splits or other distributions (except where converted to cash), a fee not in excess of U.S. \$ 5.00 per 100 ADSs (or fraction thereof) so issued under the terms of the Deposit Agreement to be determined by the Depository;
- (ii) to any person surrendering ADSs for withdrawal of Deposited Securities or whose ADSs are cancelled or reduced for any other reason including, inter alia, cash distributions made pursuant to a cancellation or withdrawal, a fee not in excess of U.S. \$ 5.00 per 100 ADSs reduced, cancelled or surrendered (as the case may be);
- (iii) to any holder of ADSs (including, without limitation, Holders), a fee not in excess of U.S. \$ 5.00 per 100 ADSs held for the distribution of cash dividends;
- (iv) to any holder of ADSs (including, without limitation, Holders), a fee not in excess of U.S. \$ 5.00 per 100 ADSs held for the distribution of cash entitlements (other than cash dividends) and/or cash proceeds, including proceeds from the sale of rights, securities and other entitlements;

- (v) to any holder of ADSs (including, without limitation, Holders), a fee not in excess of U.S. \$ 5.00 per 100 ADSs (or portion thereof) issued upon the exercise of rights; and
- (vi) for the operation and maintenance costs in administering the ADSs an annual fee not in excess of U.S. \$ 5.00 per 100 ADSs, such fee to be assessed against Holders of record as of the date or dates set by the Depositary as it sees fit and collected at the sole discretion of the Depositary by billing such Holders for such fee or by deducting such fee from one or more cash dividends or other cash distributions.

In addition, Holders, Beneficial Owners, any person depositing Shares for deposit and any person surrendering ADSs for cancellation and withdrawal of Deposited Securities will be required to pay the following charges:

- (i) taxes (including applicable interest and penalties) and other governmental charges;
- (ii) such registration fees as may from time to time be in effect for the registration of Shares or other Deposited Securities with the Foreign Registrar and applicable to transfers of Shares or other Deposited Securities to or from the name of the Custodian, the Depositary or any nominees upon the making of deposits and withdrawals, respectively;
- (iii) such cable, telex, facsimile and electronic transmission and delivery expenses as are expressly provided in the Deposit Agreement to be at the expense of the depositor depositing or person withdrawing Shares or Holders and Beneficial Owners of ADSs;
- (iv) the expenses and charges incurred by the Depositary and/or a division or Affiliate(s) of the Depositary in the conversion of Foreign Currency;
- (v) such fees and expenses as are incurred by the Depositary in connection with compliance with exchange control regulations and other regulatory requirements applicable to Shares, Deposited Securities, ADSs and ADRs;
- (vi) the fees and expenses incurred by the Depositary in connection with the delivery of Deposited Securities, including any fees of a central depository for securities in the local market, where applicable;
- (vii) any additional fees, charges, costs or expenses that may be incurred by the Depositary or a division or Affiliate(s) of the Depositary from time to time.

Any other fees and charges of, and expenses incurred by, the Depositary or the Custodian under the Deposit Agreement shall be for the account of the Company unless otherwise agreed in writing between the Company and the Depositary from time to time. All fees and charges may, at any time and from time to time, be changed by agreement between the Depositary and Company but, in the case of fees and charges payable by Holders or Beneficial Owners, only in the manner contemplated by Article (20) hereof.

The Depositary may make payments to the Company and/or may share revenue with the Company derived from fees collected from Holders and Beneficial Owners, upon such terms and conditions as the Company and the Depositary may agree from time to time.

(10) Title to Receipts. It is a condition of this Receipt, and every successive Holder of this Receipt by accepting or holding the same consents and agrees, that title to this Receipt (and to each ADS evidenced hereby) is transferable by delivery of the Receipt, provided it has been properly endorsed or accompanied by proper instruments of transfer, such Receipt being a certificated security under the laws of the State of New York. Notwithstanding any notice to the contrary, the Depositary may deem and treat the Holder of this Receipt (that is, the person in whose name this Receipt is registered on the books of the Depositary) as the absolute owner hereof for all purposes. The Depositary shall have no obligation or be subject to any liability under the Deposit Agreement or this Receipt to any holder of this Receipt or any Beneficial Owner unless such holder is the Holder of this Receipt registered on the books of the Depositary or, in the case of a Beneficial Owner, such Beneficial Owner or the Beneficial Owner's representative is the Holder registered on the books of the Depositary.

(11) Validity of Receipt. This Receipt shall not be entitled to any benefits under the Deposit Agreement or be valid or enforceable for any purpose, unless this Receipt has been (i) dated, (ii) signed by the manual or facsimile signature of a duly authorized signatory of the Depositary, (iii) if a Registrar for the Receipts shall have been appointed, countersigned by the manual or facsimile signature of a duly authorized signatory of the Registrar and (iv) registered in the books maintained by the Depositary or the Registrar, as applicable, for the issuance and transfer of Receipts. Receipts bearing the facsimile signature of a duly-authorized signatory of the Depositary or the Registrar, who at the time of signature was a duly-authorized signatory of the Depositary or the Registrar, as the case may be, shall bind the Depositary, notwithstanding the fact that such signatory has ceased to be so authorized prior to the execution and delivery of such Receipt by the Depositary or did not hold such office on the date of issuance of such Receipts.

(12) Available Information; Reports; Inspection of Transfer Books. The Company is subject to the periodic reporting requirements of the Exchange Act applicable to foreign private issuers (as defined in Rule 405 of the Securities Act) and accordingly files certain information with the Commission. These reports and documents can be inspected and copied at the public reference facilities maintained by the Commission located at 100 F Street, N.E., Washington D.C. 20549, U.S.A. The Depositary shall make available during normal business hours on any Business Day for inspection by Holders at its Corporate Trust Office any reports and communications, including any proxy soliciting materials, received from the Company which are both (a) received by the Depositary, the Custodian, or the nominee of either of them as the holder of the Deposited Securities and (b) made generally available to the holders of such Deposited Securities by the Company.

The Depositary or the Registrar, as applicable, shall keep books for the registration of Receipts and transfers of Receipts which at all reasonable times shall be open for inspection by the Company and by the Holders of such Receipts, provided that such inspection shall not be, to the Depositary's or the Registrar's knowledge, for the purpose of communicating with Holders of such Receipts in the interest of a business or object other than the business of the Company or other than a matter related to the Deposit Agreement or the Receipts.

The Depositary or the Registrar, as applicable, may close the transfer books with respect to the Receipts, at any time or from time to time, when deemed necessary or advisable by it in good faith in connection with the performance of its duties hereunder, or at the reasonable written request of the Company subject, in all cases, to Article (22) hereof.

Dated:

**DEUTSCHE BANK TRUST COMPANY AMERICAS, as Depositary**

By: \_\_\_\_\_

By: \_\_\_\_\_

The address of the Corporate Trust Office of the Depositary is 1 Columbus Circle, New York, New York 10019, U.S.A.

**[FORM OF REVERSE OF RECEIPT]**  
SUMMARY OF CERTAIN ADDITIONAL PROVISIONS  
OF THE DEPOSIT AGREEMENT

(13) Dividends and Distributions in Cash, Shares, etc. Whenever the Depositary receives confirmation from the Custodian of receipt of any cash dividend or other cash distribution on any Deposited Securities, or receives proceeds from the sale of any Shares, rights securities or other entitlements under the Deposit Agreement, the Depositary will, if at the time of receipt thereof any amounts received in a Foreign Currency can, in the judgment of the Depositary (upon the terms of the Deposit Agreement), be converted on a practicable basis, into Dollars transferable to the United States, promptly convert or cause to be converted such dividend, distribution or proceeds into Dollars and will distribute promptly the amount thus received (net of applicable fees and charges of, and expenses incurred by, the Depositary and/or a division or Affiliate(s) of the Depositary and taxes and/or governmental charges) to the Holders of record as of the ADS Record Date in proportion to the number of ADSs representing such Deposited Securities held by such Holders respectively as of the ADS Record Date. The Depositary shall distribute only such amount, however, as can be distributed without attributing to any Holder a fraction of one cent. Any such fractional amounts shall be rounded down to the nearest whole cent and so distributed to Holders entitled thereto. Holders and Beneficial Owners understand that in converting Foreign Currency, amounts received on conversion are calculated at a rate which exceeds the number of decimal places used by the Depositary to report distribution rates. The excess amount may be retained by the Depositary as an additional cost of conversion, irrespective of any other fees and expenses payable or owing hereunder and shall not be subject to escheatment. If the Company, the Custodian or the Depositary is required to withhold and does withhold from any cash dividend or other cash distribution in respect of any Deposited Securities an amount on account of taxes, duties or other governmental charges, the amount distributed to Holders on the ADSs representing such Deposited Securities shall be reduced accordingly. Such withheld amounts shall be forwarded by the Company, the Custodian or the Depositary to the relevant governmental authority. Evidence of payment thereof by the Company shall be forwarded by the Company to the Depositary upon request. The Depositary shall forward to the Company or its agent such information from its records as the Company may reasonably request to enable the Company or its agent to file with governmental agencies such reports as are necessary to obtain benefits under the applicable tax treaties for the Holders and Beneficial Owners of Receipts.

If any distribution upon any Deposited Securities consists of a dividend in, or free distribution of, Shares, the Company shall cause such Shares to be deposited with the Custodian and registered, as the case may be, in the name of the Depositary, the Custodian or their nominees. Upon receipt of confirmation of such deposit, the Depositary shall, subject to and in accordance with the Deposit Agreement, establish the ADS Record Date and either (i) distribute to the Holders as of the ADS Record Date in proportion to the number of ADSs held by such Holders as of the ADS Record Date, additional ADSs, which represent in aggregate the number of Shares received as such dividend, or free distribution, subject to the terms of the Deposit Agreement (including, without limitation, the applicable fees and charges of, and expenses incurred by, the Depositary, and taxes and/or governmental charges), or (ii) if additional ADSs are not so distributed, each ADS issued and outstanding after the ADS Record Date shall, to the extent permissible by law, thenceforth also represent rights and interests in the additional Shares distributed upon the Deposited Securities represented thereby (net of the applicable fees and charges of, and the expenses incurred by, the Depositary, and taxes and/or governmental charges). In lieu of delivering fractional ADSs, the Depositary shall sell the number of Shares represented by the aggregate of such fractions and distribute the proceeds upon the terms set forth in the Deposit Agreement.

In the event that (x) the Depositary determines that any distribution in property (including Shares) is subject to any tax or other governmental charges which the Depositary is obligated to withhold, or, (y) if the Company, in the fulfillment of its obligations under the Deposit Agreement, has either (a) furnished an opinion of U.S. counsel determining that Shares must be registered under the Securities Act or other laws in order to be distributed to Holders (and no such registration statement has been declared effective), or (b) fails to timely deliver the documentation contemplated in the Deposit Agreement, the Depositary may dispose of all or a portion of such property (including Shares and rights to subscribe therefor) in such amounts and in such manner, including by public or private sale, as the Depositary deems necessary and practicable, and the Depositary shall distribute the net proceeds of any such sale (after deduction of taxes and/or governmental charges, and fees and charges of, and expenses incurred by, the Depositary and/or a division or Affiliate(s) of the Depositary) to Holders entitled thereto upon the terms of the Deposit Agreement. The Depositary shall hold and/or distribute any unsold balance of such property in accordance with the provisions of the Deposit Agreement.

Upon timely receipt of a notice indicating that the Company wishes an elective distribution to be made available to Holders upon the terms described in the Deposit Agreement, the Depositary shall, upon provision of all documentation required under the Deposit Agreement, (including, without limitation, any legal opinions the Depositary may request under the Deposit Agreement) determine whether such distribution is lawful and reasonably practicable. If so, the Depositary shall, subject to the terms and conditions of the Deposit Agreement, establish an ADS Record Date according to Article (14) hereof and establish procedures to enable the Holder hereof to elect to receive the proposed distribution in cash or in additional ADSs. If a Holder elects to receive the distribution in cash, the dividend shall be distributed as in the case of a distribution in cash. If the Holder hereof elects to receive the distribution in additional ADSs, the distribution shall be distributed as in the case of a distribution in Shares upon the terms described in the Deposit Agreement. If such elective distribution is not lawful or reasonably practicable or if the Depositary did not receive satisfactory documentation set forth in the Deposit Agreement, the Depositary shall, to the extent permitted by law, distribute to Holders, on the basis of the same determination as is made in the Cayman Islands, in respect of the Shares for which no election is made, either (x) cash or (y) additional ADSs representing such additional Shares, in each case, upon the terms described in the Deposit Agreement. Nothing herein shall obligate the Depositary to make available to the Holder hereof a method to receive the elective dividend in Shares (rather than ADSs). There can be no assurance that the Holder hereof will be given the opportunity to receive elective distributions on the same terms and conditions as the holders of Shares.

Whenever the Company intends to distribute to the holders of the Deposited Securities rights to subscribe for additional Shares, the Company shall give notice thereof to the Depository at least 45 days prior to the proposed distribution stating whether or not it wishes such rights to be made available to Holders of ADSs. Upon timely receipt by the Depository of a notice indicating that the Company wishes such rights to be made available to Holders of ADSs, the Company shall determine whether it is lawful and reasonably practicable to make such rights available to the Holders. The Depository shall make such rights available to any Holders only if the Company shall have timely requested that such rights be made available to Holders, the Depository shall have received the documentation required by the Deposit Agreement, and the Depository shall have determined that such distribution of rights is lawful and reasonably practicable. If such conditions are not satisfied, the Depository shall sell the rights as described below. In the event all conditions set forth above are satisfied, the Depository shall establish an ADS Record Date and establish procedures (x) to distribute such rights (by means of warrants or otherwise) and (y) to enable the Holders to exercise the rights (upon payment of the applicable fees and charges of, and expenses incurred by, the Depository and/or a division or Affiliate(s) of the Depository and taxes and/or governmental charges). Nothing herein or in the Deposit Agreement shall obligate the Depository to make available to the Holders a method to exercise such rights to subscribe for Shares (rather than ADSs). If (i) the Company does not timely request the Depository to make the rights available to Holders or if the Company requests that the rights not be made available to Holders, (ii) the Depository fails to receive the documentation required by the Deposit Agreement or determines it is not lawful or reasonably practicable to make the rights available to Holders, or (iii) any rights made available are not exercised and appear to be about to lapse, the Depository shall determine whether it is lawful and reasonably practicable to sell such rights, and if it so determines that it is lawful and reasonably practicable, endeavour to sell such rights in a riskless principal capacity or otherwise, at such place and upon such terms (including public and/or private sale) as it may deem proper. The Depository shall, upon such sale, convert and distribute proceeds of such sale (net of applicable fees and charges of, and expenses incurred by, the Depository and/or a division or Affiliate(s) of the Depository and taxes and/or governmental charges) upon the terms hereof and in the Deposit Agreement. If the Depository is unable to make any rights available to Holders or to arrange for the sale of the rights upon the terms described above, the Depository shall allow such rights to lapse. The Depository shall not be responsible for (i) any failure to determine that it may be lawful or practicable to make such rights available to Holders in general or any Holders in particular, (ii) any foreign exchange exposure or loss incurred in connection with such sale, or exercise, or (iii) the content of any materials forwarded to the Holders on behalf of the Company in connection with the rights distribution.

Notwithstanding anything herein to the contrary, if registration (under the Securities Act and/or any other applicable law) of the rights or the securities to which any rights relate may be required in order for the Company to offer such rights or such securities to Holders and to sell the securities represented by such rights, the Depository will not distribute such rights to the Holders (i) unless and until a registration statement under the Securities Act covering such offering is in effect or (ii) unless the Company furnishes to the Depository opinion(s) of counsel for the Company in the United States and counsel to the Company in any other applicable country in which rights would be distributed, in each case satisfactorily to the Depository, to the effect that the offering and sale of such securities to Holders and Beneficial Owners are exempt from, or do not require registration under, the provisions of the Securities Act or any other applicable laws. In the event that the Company, the Depository or the Custodian shall be required to withhold and does withhold from any distribution of property (including rights) an amount on account of taxes and/or other governmental charges, the amount distributed to the Holders shall be reduced accordingly. In the event that the Depository determines that any distribution in property (including Shares and rights to subscribe therefor) is subject to any tax or other governmental charges which the Depository is obligated to withhold, the Depository may dispose of all or a portion of such property (including Shares and rights to subscribe therefor) in such amounts and in such manner, including by public or private sale, as the Depository deems necessary and practicable to pay any such taxes and/or charges.



There can be no assurance that Holders generally, or any Holder in particular, will be given the opportunity to exercise rights on the same terms and conditions as the holders of Shares or to exercise such rights. Nothing herein shall obligate the Company to file any registration statement in respect of any rights or Shares or other securities to be acquired upon the exercise of such rights or otherwise to register or qualify the offer or sale of such rights or securities under the applicable law of any other jurisdiction for any purpose.

Upon receipt of a notice regarding property other than cash, Shares or rights to purchase additional Shares, to be made to Holders of ADSs, the Depositary shall determine, after consultation with the Company, whether such distribution to Holders is lawful and reasonably practicable. The Depositary shall not make such distribution unless (i) the Company shall have timely requested the Depositary to make such distribution to Holders, (ii) the Depositary shall have received the documentation required by the Deposit Agreement, and (iii) the Depositary shall have determined that such distribution is lawful and reasonably practicable. Upon satisfaction of such conditions, the Depositary shall distribute the property so received to the Holders of record as of the ADS Record Date, in proportion to the number of ADSs held by such Holders respectively and in such manner as the Depositary may deem practicable for accomplishing such distribution (i) upon receipt of payment or net of the applicable fees and charges of, and expenses incurred by, the Depositary, and (ii) net of any taxes and/or governmental charges. The Depositary may dispose of all or a portion of the property so distributed and deposited, in such amounts and in such manner (including public or private sale) as the Depositary may deem practicable or necessary to satisfy any taxes (including applicable interest and penalties) or other governmental charges applicable to the distribution.

If the conditions above are not satisfied, the Depositary shall sell or cause such property to be sold in a public or private sale, at such place or places and upon such terms as it may deem proper and shall distribute the proceeds of such sale received by the Depositary (net of (a) applicable fees and charges of, and expenses incurred by, the Depositary and/or a division or Affiliate(s) of the Depositary and (b) taxes and/or governmental charges) to the Holders upon the terms hereof and of the Deposit Agreement. If the Depositary is unable to sell such property, the Depositary may dispose of such property in any way it deems reasonably practicable under the circumstances.

(14) **Fixing of Record Date.** Whenever necessary in connection with any distribution (whether in cash, Shares, rights or other distribution), or whenever for any reason the Depositary causes a change in the number of Shares that are represented by each ADS, or whenever the Depositary shall receive notice of any meeting or solicitation of holders of Shares or other Deposited Securities, or whenever the Depositary shall find it necessary or convenient in connection with the giving of any notice, or any other matter, the Depositary shall fix a record date (the "ADS Record Date"), as close as practicable to the record date fixed by the Company with respect to the Shares (if applicable), for the determination of the Holders who shall be entitled to receive such distribution, to give instructions for the exercise of voting rights at any such meeting, or to give or withhold such consent, or to receive such notice or solicitation or to otherwise take action, or to exercise the rights of Holders with respect to such changed number of Shares represented by each ADS or for any other reason. Subject to applicable law and the terms and conditions of this Receipt and the Deposit Agreement, only the Holders of record at the close of business in New York on such ADS Record Date shall be entitled to receive such distributions, to give such voting instructions, to receive such notice or solicitation, or otherwise take action.

(15) Voting of Deposited Securities. Subject to the next sentence, as soon as practicable after receipt of notice of any meeting at which the holders of Deposited Securities are entitled to vote, or of solicitation of consents or proxies from holders of Deposited Securities, the Depositary shall fix the ADS Record Date in respect of such meeting or such solicitation of consents or proxies. The Depositary shall, if requested by the Company in writing in a timely manner (the Depositary having no obligation to take any further action if the request shall not have been received by the Depositary at least 30 Business Days prior to the date of such vote or meeting) and at the Company's expense, and provided no U.S. legal prohibitions exist, mail by regular, ordinary mail delivery (or by electronic mail or as otherwise may be agreed between the Company and the Depositary in writing from time to time) or otherwise distribute as soon as practicable after receipt thereof to Holders as of the ADS Record Date: (a) such notice of meeting or solicitation of consent or proxy; (b) a statement that the Holders at the close of business on the ADS Record Date will be entitled, subject to any applicable law, the provisions of the Deposit Agreement, the Company's Memorandum and Articles of Association and the provisions of or governing the Deposited Securities (which provisions, if any, shall be summarized in pertinent part by the Company), to instruct the Depositary as to the exercise of the voting rights, if any, pertaining to the Deposited Securities represented by such Holder's American Depositary Shares; and (c) a brief statement as to the manner in which such voting instructions may be given to the Depositary, or in which instructions may be deemed to have been given in accordance with this Article (15), including an express indication that instructions may be given (or be deemed to have been given in accordance with the immediately following paragraph of this section if no instruction is received) to the Depositary to give a discretionary proxy to a person or persons designated by the Company. Voting instructions may be given only in respect of a number of American Depositary Shares representing an integral number of Deposited Securities. Upon the timely receipt of voting instructions of a Holder on the ADS Record Date in the manner specified by the Depositary, the Depositary shall endeavor, insofar as practicable and permitted under applicable law, the provisions of the Deposit Agreement, the Company's Memorandum and Articles of Association and the provisions of or governing the Deposited Securities, to vote or cause the Custodian to vote the Deposited Securities (in person or by proxy) represented by American Depositary Shares evidenced by such Receipt in accordance with such voting instructions.

In the event that (i) the Depositary timely receives voting instructions from a Holder which fail to specify the manner in which the Depositary is to vote the Deposited Securities represented by such Holder's ADSs or (ii) no timely instructions are received by the Depositary from a Holder with respect to any of the Deposited Securities represented by the ADSs held by such Holder on the ADS Record Date, the Depositary shall (unless otherwise specified in the notice distributed to Holders) deem such Holder to have instructed the Depositary to give a discretionary proxy to a person designated by the Company with respect to such Deposited Securities and the Depositary shall give a discretionary proxy to a person designated by the Company to vote such Deposited Securities, provided, however, that no such instruction shall be deemed to have been given and no such discretionary proxy shall be given with respect to any matter as to which the Company informs the Depositary (and the Company agrees to provide such information as promptly as practicable in writing, if applicable) that (x) the Company does not wish to give such proxy, (y) the Company is aware or should reasonably be aware that substantial opposition exists from Holders against the outcome for which the person designated by the Company would otherwise vote or (z) the outcome for which the person designated by the Company would otherwise vote would materially and adversely affect the rights of holders of Deposited Securities, provided, further, that the Company will have no liability to any Holder or Beneficial Owner resulting from such notification.

In the event that voting on any resolution or matter is conducted on a show of hands basis in accordance with the Memorandum and Articles of Association, the Depositary will refrain from voting and the voting instructions (or the deemed voting instructions, as set out above) received by the Depositary from Holders shall lapse. The Depositary will have no obligation to demand voting on a poll basis with respect to any resolution and shall have no liability to any Holder or Beneficial Owner for not having demanded voting on a poll basis.

Neither the Depositary nor the Custodian shall, under any circumstances exercise any discretion as to voting, and neither the Depositary nor the Custodian shall vote, attempt to exercise the right to vote, or in any way make use of for purposes of establishing a quorum or otherwise, Deposited Securities represented by ADSs except pursuant to and in accordance with such written instructions from Holders, including the deemed instruction to the Depositary to give a discretionary proxy to a person designated by the Company. Deposited Securities represented by ADSs for which (i) no timely voting instructions are received by the Depositary from the Holder, or (ii) timely voting instructions are received by the Depositary from the Holder but such voting instructions fail to specify the manner in which the Depositary is to vote the Deposited Securities represented by such Holder's ADSs, shall be voted in the manner provided in this Article (15). Notwithstanding anything else contained herein, and subject to applicable law, regulation and the Memorandum and Articles of Association, the Depositary shall, if so requested in writing by the Company, represent all Deposited Securities (whether or not voting instructions have been received in respect of such Deposited Securities from Holders as of the ADS Record Date) for the purpose of establishing quorum at a meeting of shareholders.

There can be no assurance that Holders or Beneficial Owners generally or any Holder or Beneficial Owner in particular will receive the notice described above with sufficient time to enable the Holder to return voting instructions to the Depositary in a timely manner.

Notwithstanding the above, save for applicable provisions of the law of the Cayman Islands, and in accordance with the terms of Section 5.3 of the Deposit Agreement, the Depositary shall not be liable for any failure to carry out any instructions to vote any of the Deposited Securities or the manner in which such vote is cast or the effect of such vote.

(16) Changes Affecting Deposited Securities. Upon any change in par value, split-up, subdivision, cancellation, consolidation or any other reclassification of Deposited Securities, or upon any recapitalization, reorganization, merger, amalgamation or consolidation or sale of assets affecting the Company or to which it otherwise is a party, any securities which shall be received by the Depositary or a Custodian in exchange for, or in conversion of or replacement or otherwise in respect of, such Deposited Securities shall, to the extent permitted by law, be treated as new Deposited Securities under the Deposit Agreement, and the Receipts shall, subject to the provisions of the Deposit Agreement and applicable law, evidence ADSs representing the right to receive such additional securities. Alternatively, the Depositary may, with the Company's approval, and shall, if the Company shall so requests, subject to the terms of the Deposit Agreement and receipt of satisfactory documentation contemplated by the Deposit Agreement, execute and deliver additional Receipts as in the case of a stock dividend on the Shares, or call for the surrender of outstanding Receipts to be exchanged for new Receipts, in either case, as well as in the event of newly deposited Shares, with necessary modifications to this form of Receipt specifically describing such new Deposited Securities and/or corporate change. Notwithstanding the foregoing, in the event that any security so received may not be lawfully distributed to some or all Holders, the Depositary may, with the Company's approval, and shall if the Company requests, subject to receipt of satisfactory legal documentation contemplated in the Deposit Agreement, sell such securities at public or private sale, at such place or places and upon such terms as it may deem proper and may allocate the net proceeds of such sales (net of fees and charges of, and expenses incurred by, the Depositary and/or a division or Affiliate(s) of the Depositary and taxes and/or governmental charges) for the account of the Holders otherwise entitled to such securities and distribute the net proceeds so allocated to the extent practicable as in the case of a distribution received in cash pursuant to the Deposit Agreement. The Depositary shall not be responsible for (i) any failure to determine that it may be lawful or feasible to make such securities available to Holders in general or any Holder in particular, (ii) any foreign exchange exposure or loss incurred in connection with such sale, or (iii) any liability to the purchaser of such securities.

(17) Exoneration. None of the Depositary, the Custodian or the Company shall be obligated to do or perform any act which is inconsistent with the provisions of the Deposit Agreement or shall incur any liability to Holders, Beneficial Owners or any third parties (i) if the Depositary, the Custodian or the Company or their respective controlling persons or agents shall be prevented or forbidden from, or subjected to any civil or criminal penalty or restraint on account of, or delayed in, doing or performing any act or thing required by the terms of the Deposit Agreement and this Receipt, by reason of any provision of any present or future law or regulation of the United States, the Cayman Islands or any other country, or of any other governmental authority or regulatory authority or stock exchange, or by reason of any provision, present or future of the Memorandum and Articles of Association or any provision of or governing any Deposited Securities, or by reason of any act of God or war or other circumstances beyond its control, (including, without limitation, nationalization, expropriation, currency restrictions, work stoppage, strikes, civil unrest, revolutions, rebellions, explosions and computer failure), (ii) by reason of any exercise of, or failure to exercise, any discretion provided for in the Deposit Agreement or in the Memorandum and Articles of Association or provisions of or governing Deposited Securities, (iii) for any action or inaction of the Depositary, the Custodian or the Company or their respective controlling persons or agents in reliance upon the advice of or information from legal counsel, accountants, any person presenting Shares for deposit, any Holder, any Beneficial Owner or authorized representative thereof, or any other person believed by it in good faith to be competent to give such advice or information, (iv) for any inability by a Holder or Beneficial Owner to benefit from any distribution, offering, right or other benefit which is made available to holders of Deposited Securities but is not, under the terms of the Deposit Agreement, made available to Holders of ADS or (v) for any special, consequential, indirect or punitive damages for any breach of the terms of the Deposit Agreement or otherwise. The Depositary, its controlling persons, its agents (including without limitation, the Agents), any Custodian and the Company, its controlling persons and its agents may rely and shall be protected in acting upon any written notice, request, opinion or other document believed by it to be genuine and to have been signed or presented by the proper party or parties. No disclaimer of liability under the Securities Act or the Exchange Act is intended by any provision of the Deposit Agreement.

(18) Standard of Care. The Company and the Depositary and their respective directors, officers, Affiliates, employees and agents (including without limitation, the Agents) assume no obligation and shall not be subject to any liability under the Deposit Agreement or the Receipts to Holders or Beneficial Owners or other persons, except in accordance with Section 5.8 of the Deposit Agreement, provided, that the Company and the Depositary and their respective directors, officers, Affiliates, employees and agents (including without limitation, the Agents) agree to perform their respective obligations specifically set forth in the Deposit Agreement without gross negligence or willful misconduct. The Depositary and its directors, officers, Affiliates, employees and agents (including without limitation, the Agents) shall not be liable for any failure to carry out any instructions to vote any of the Deposited Securities, or for the manner in which any vote is cast or the effect of any vote. The Depositary shall not incur any liability for any failure to determine that any distribution or action may be lawful or reasonably practicable, for the content of any information submitted to it by the Company for distribution to the Holders or for any inaccuracy of any translation thereof, for any investment risk associated with acquiring an interest in the Deposited Securities, for the validity or worth of the Deposited Securities or for any tax consequences that may result from the ownership of ADSs, Shares or Deposited Securities, for the credit-worthiness of any third party, for allowing any rights to lapse upon the terms of the Deposit Agreement or for the failure or timeliness of any notice from the Company or for any action or non action by it in reliance upon the opinion, advice of or information from legal counsel, accountants, any person presenting Shares for deposit, any Holder or any other person believed by it in good faith to be competent to give such advice or information. The Depositary and its agents (including without limitation, the Agents) shall not be liable for any acts or omissions made by a successor depositary whether in connection with a previous act or omission of the Depositary or in connection with any matter arising wholly after the removal or resignation of the Depositary, provided that in connection with the issue out of which such potential liability arises the Depositary performed its obligations without gross negligence or willful misconduct while it acted as Depositary.

(19) Resignation and Removal of the Depositary; Appointment of Successor Depositary. The Depositary may at any time resign as Depositary under the Deposit Agreement by written notice of resignation delivered to the Company, such resignation to be effective on the earlier of (i) the 90th day after delivery thereof to the Company (whereupon the Depositary shall, in the event no successor depositary has been appointed by the Company, be entitled to take the actions contemplated in the Deposit Agreement), or (ii) the appointment of a successor depositary and its acceptance of such appointment as provided in the Deposit Agreement, save that, any amounts, fees, costs or expenses owed to the Depositary under the Deposit Agreement or in accordance with any other agreements otherwise agreed in writing between the Company and the Depositary from time to time shall be paid to the Depositary prior to such resignation. The Company shall use reasonable efforts to appoint such successor depositary, and give notice to the Depositary of such appointment, not more than 90 days after delivery by the Depositary of written notice of resignation as provided in the Deposit Agreement. The Depositary may at any time be removed by the Company by written notice of such removal which notice shall be effective on the later of (i) the 90th day after delivery thereof to the Depositary (whereupon the Depositary shall be entitled to take the actions contemplated in the Deposit Agreement if a successor depositary has not been appointed), or (ii) the appointment of a successor depositary and its acceptance of such appointment as provided in the Deposit Agreement save that, any amounts, fees, costs or expenses owed to the Depositary under the Deposit Agreement or in accordance with any other agreements otherwise agreed in writing between the Company and the Depositary from time to time shall be paid to the Depositary prior to such removal. In case at any time the Depositary acting hereunder shall resign or be removed, the Company shall use its best efforts to appoint a successor depositary which shall be a bank or trust company having an office in the Borough of Manhattan, the City of New York and if it shall have not appointed a successor depositary the provisions referred to in Article (21) hereof and correspondingly in the Deposit Agreement shall apply. Every successor depositary shall be required by the Company to execute and deliver to its predecessor and to the Company an instrument in writing accepting its appointment hereunder, and thereupon such successor depositary, without any further act or deed, shall become fully vested with all the rights, powers, duties and obligations of its predecessor. The predecessor depositary, upon payment of all sums due to it and on the written request of the Company, shall (i) execute and deliver an instrument transferring to such successor all rights and powers of such predecessor hereunder (other than as contemplated in the Deposit Agreement), (ii) duly assign, transfer and deliver all right, title and interest to the Deposited Securities to such successor, and (iii) deliver to such successor a list of the Holders of all outstanding Receipts and such other information relating to Receipts and Holders thereof as the successor may reasonably request. Any such successor depositary shall promptly mail notice of its appointment to such Holders. Any corporation into or with which the Depositary may be merged or consolidated shall be the successor of the Depositary without the execution or filing of any document or any further act and, notwithstanding anything to the contrary in the Deposit Agreement, the Depositary may assign or otherwise transfer all or any of its rights and benefits under the Deposit Agreement (including any cause of action arising in connection with it) to Deutsche Bank AG or any branch thereof or any entity which is a direct or indirect subsidiary or other affiliate of Deutsche Bank AG.

(20) Amendment/Supplement. Subject to the terms and conditions of this Article (20), and applicable law, this Receipt and any provisions of the Deposit Agreement may at any time and from time to time be amended or supplemented by written agreement between the Company and the Depository in any respect which they may deem necessary or desirable without the consent of the Holders or Beneficial Owners. Any amendment or supplement which shall impose or increase any fees or charges (other than the charges of the Depository in connection with foreign exchange control regulations, and taxes and/or other governmental charges, delivery and other such expenses), or which shall otherwise materially prejudice any substantial existing right of Holders or Beneficial Owners, shall not, however, become effective as to outstanding Receipts until 30 days after notice of such amendment or supplement shall have been given to the Holders of outstanding Receipts. Notice of any amendment to the Deposit Agreement or form of Receipts shall not need to describe in detail the specific amendments effectuated thereby, and failure to describe the specific amendments in any such notice shall not render such notice invalid, provided, however, that, in each such case, the notice given to the Holders identifies a means for Holders and Beneficial Owners to retrieve or receive the text of such amendment (i.e., upon retrieval from the Commission's, the Depository's or the Company's website or upon request from the Depository). The parties hereto agree that any amendments or supplements which (i) are reasonably necessary (as agreed by the Company and the Depository) in order for (a) the ADSs to be registered on Form F-6 under the Securities Act or (b) the ADSs or Shares to be traded solely in electronic book-entry form and (ii) do not in either such case impose or increase any fees or charges to be borne by Holders, shall be deemed not to materially prejudice any substantial rights of Holders or Beneficial Owners. Every Holder and Beneficial Owner at the time any amendment or supplement so becomes effective shall be deemed, by continuing to hold such ADS, to consent and agree to such amendment or supplement and to be bound by the Deposit Agreement as amended or supplemented thereby. In no event shall any amendment or supplement impair the right of the Holder to surrender such Receipt and receive therefor the Deposited Securities represented thereby, except in order to comply with mandatory provisions of applicable law. Notwithstanding the foregoing, if any governmental body should adopt new laws, rules or regulations which would require amendment or supplement of the Deposit Agreement to ensure compliance therewith, the Company and the Depository may amend or supplement the Deposit Agreement and the Receipt at any time in accordance with such changed laws, rules or regulations. Such amendment or supplement to the Deposit Agreement in such circumstances may become effective before a notice of such amendment or supplement is given to Holders or within any other period of time as required for compliance with such laws, or rules or regulations.

(21) Termination. The Depositary shall, at any time at the written direction of the Company, terminate the Deposit Agreement by mailing notice of such termination to the Holders of all Receipts then outstanding at least 90 days prior to the date fixed in such notice for such termination provided that, the Depositary shall be reimbursed for any amounts, fees, costs or expenses owed to it in accordance with the terms of the Deposit Agreement and in accordance with any other agreements as otherwise agreed in writing between the Company and the Depositary from time to time, prior to such termination shall take effect. If 90 days shall have expired after (i) the Depositary shall have delivered to the Company a written notice of its election to resign, or (ii) the Company shall have delivered to the Depositary a written notice of the removal of the Depositary, and in either case a successor depositary shall not have been appointed and accepted its appointment as provided herein and in the Deposit Agreement, the Depositary may terminate the Deposit Agreement by mailing notice of such termination to the Holders of all Receipts then outstanding at least 30 days prior to the date fixed for such termination. On and after the date of termination of the Deposit Agreement, each Holder will, upon surrender of such Holder's Receipt at the Corporate Trust Office of the Depositary, upon the payment of the charges of the Depositary for the surrender of Receipts referred to in Article (2) hereof and in the Deposit Agreement and subject to the conditions and restrictions therein set forth, and upon payment of any applicable taxes and/or governmental charges, be entitled to delivery, to him or upon his order, of the amount of Deposited Securities represented by such Receipt. If any Receipts shall remain outstanding after the date of termination of the Deposit Agreement, the Registrar thereafter shall discontinue the registration of transfers of Receipts, and the Depositary shall suspend the distribution of dividends to the Holders thereof, and shall not give any further notices or perform any further acts under the Deposit Agreement, except that the Depositary shall continue to collect dividends and other distributions pertaining to Deposited Securities, shall sell rights or other property as provided in the Deposit Agreement, and shall continue to deliver Deposited Securities, subject to the conditions and restrictions set forth in the Deposit Agreement, together with any dividends or other distributions received with respect thereto and the net proceeds of the sale of any rights or other property, in exchange for Receipts surrendered to the Depositary (after deducting, or charging, as the case may be, in each case the charges of the Depositary for the surrender of a Receipt, any expenses for the account of the Holder in accordance with the terms and conditions of the Deposit Agreement and any applicable taxes and/or governmental charges or assessments). At any time after the expiration of six months from the date of termination of the Deposit Agreement, the Depositary may sell the Deposited Securities then held hereunder and may thereafter hold uninvested the net proceeds of any such sale, together with any other cash then held by it hereunder, in an unsegregated account, without liability for interest for the pro rata benefit of the Holders of Receipts whose Receipts have not theretofore been surrendered. After making such sale, the Depositary shall be discharged from all obligations under the Deposit Agreement with respect to the Receipts and the Shares, Deposited Securities and ADSs, except to account for such net proceeds and other cash (after deducting, or charging, as the case may be, in each case the charges of the Depositary for the surrender of a Receipt, any expenses for the account of the Holder in accordance with the terms and conditions of the Deposit Agreement and any applicable taxes and/or governmental charges or assessments) and except as set forth in the Deposit Agreement. Upon the termination of the Deposit Agreement, the Company shall be discharged from all obligations under the Deposit Agreement except as set forth in the Deposit Agreement. The obligations under the terms of the Deposit Agreement and Receipts of Holders and Beneficial Owners of ADSs outstanding as of the effective date of any termination shall survive such effective date of termination and shall be discharged only when the applicable ADSs are presented by their Holders to the Depositary for cancellation under the terms of the Deposit Agreement and the Holders have each satisfied any and all of their obligations hereunder (including, but not limited to, any payment and/or reimbursement obligations which relate to prior to the effective date of termination but which payment and/or reimbursement is claimed after such effective date of termination).

Notwithstanding anything contained in the Deposit Agreement or any ADR, in connection with the termination of the Deposit Agreement, the Depositary may, independently and without the need for any action by the Company, make available to Holders of ADSs a means to withdraw the Deposited Securities represented by their ADSs and to direct the deposit of such Deposited Securities into an unsponsored American depository shares program established by the Depositary, upon such terms and conditions as the Depositary may deem reasonably appropriate, subject however, in each case, to satisfaction of the applicable registration requirements by the unsponsored American depository shares program under the Securities Act, and to receipt by the Depositary of payment of the applicable fees and charges of, and reimbursement of the applicable expenses incurred by, the Depositary.

(22) Compliance with U.S. Securities Laws: Regulatory Compliance. Notwithstanding any provisions in this Receipt or the Deposit Agreement to the contrary, the withdrawal or Delivery of Deposited Securities will not be suspended by the Company or the Depositary except as would be permitted by Section I.A.(1) of the General Instructions to Form F-6 Registration Statement, as amended from time to time, under the Securities Act.

(23) Certain Rights of the Depositary. The Depositary, its Affiliates and their agents, on their own behalf, may own and deal in any class of securities of the Company and its Affiliates and in ADSs. The Depositary may issue ADSs against evidence of rights to receive Shares from the Company, any agent of the Company or any custodian, registrar, transfer agent, clearing agency or other entity involved in ownership or transaction records in respect of the Shares.

(24) Ownership Restrictions. Owners and Beneficial Owners shall comply with any limitations on ownership of Shares under the Memorandum and Articles of Association or applicable Cayman Islands law as if they held the number of Shares their American Depositary Shares represent. The Company shall inform the Owners, Beneficial Owners and the Depositary of any such ownership restrictions in place from time to time.

(25) Waiver. EACH PARTY TO THE DEPOSIT AGREEMENT (INCLUDING, FOR AVOIDANCE OF DOUBT, EACH HOLDER AND BENEFICIAL OWNER AND/OR HOLDER OF INTERESTS IN ANY ADRs) HEREBY IRREVOCABLY WAIVES, TO THE FULLEST EXTENT PERMITTED BY APPLICABLE LAW, ANY RIGHT IT MAY HAVE TO A TRIAL BY JURY IN ANY SUIT, ACTION OR PROCEEDING AGAINST THE DEPOSITARY AND/OR THE COMPANY DIRECTLY OR INDIRECTLY ARISING OUT OF OR RELATING TO THE SHARES OR OTHER DEPOSITED SECURITIES, THE ADSs OR THE ADRs, THE DEPOSIT AGREEMENT OR ANY TRANSACTION CONTEMPLATED HEREIN OR THEREIN, OR THE BREACH HEREOF OR THEREOF (WHETHER BASED ON CONTRACT, TORT, COMMON LAW OR ANY OTHER THEORY).



**(ASSIGNMENT AND TRANSFER SIGNATURE LINES)**

FOR VALUE RECEIVED, the undersigned Holder hereby sell(s), assign(s) and transfer(s) unto \_\_\_\_\_ whose taxpayer identification number is \_\_\_\_\_ and whose address including postal zip code is \_\_\_\_\_, the within Receipt and all rights thereunder, hereby irrevocably constituting and appointing \_\_\_\_\_ attorney-in-fact to transfer said Receipt on the books of the Depository with full power of substitution in the premises.

Dated:

Name: \_\_\_\_\_

By:

Title:

NOTICE: The signature of the Holder to this assignment must correspond with the name as written upon the face of the within instrument in every particular, without alteration or enlargement or any change whatsoever.

If the endorsement be executed by an attorney, executor, administrator, trustee or guardian, the person executing the endorsement must give his/her full title in such capacity and proper evidence of authority to act in such capacity, if not on file with the Depository, must be forwarded with this Receipt.

SIGNATURE GUARANTEED

\_\_\_\_\_

ARTICLE I.	DEFINITIONS		1
	SECTION 1.1	“Affiliate”	1
	SECTION 1.2	“Agent”	1
	SECTION 1.3	“American Depositary Share(s)” and “ADS(s)”	2
	SECTION 1.4	“Article”	2
	SECTION 1.5	“Articles of Association”	2
	SECTION 1.6	“ADS Record Date”	2
	SECTION 1.7	“Beneficial Owner”	2
	SECTION 1.8	“Business Day”	2
	SECTION 1.9	“Commission”	2
	SECTION 1.10	“Company”	2
	SECTION 1.11	“Corporate Trust Office”	2
	SECTION 1.12	“Custodian”	2
	SECTION 1.13	“Deliver”, “Deliverable” and “Delivery”	3
	SECTION 1.14	“Deposit Agreement”	3
	SECTION 1.15	“Depositary”	3
	SECTION 1.16	“Deposited Securities”	3
	SECTION 1.17	“Dollars” and “\$”	3
	SECTION 1.18	“DRS/Profile”	3
	SECTION 1.19	“DTC”	3
	SECTION 1.20	“DTC Participants”	3
	SECTION 1.21	“Exchange Act”	3
	SECTION 1.22	“Foreign Currency”	3
	SECTION 1.23	“Foreign Registrar”	3
	SECTION 1.24	“Holder”	3
	SECTION 1.25	“Indemnified Person” and “Indemnifying Person”	4
	SECTION 1.26	“Losses”	4
	SECTION 1.27	“Memorandum”	4
	SECTION 1.28	“Opinion of Counsel”	4
	SECTION 1.29	“Receipt(s); “American Depositary Receipt(s)”; and “ADR(s)”	4
	SECTION 1.30	“Registrar”	4
	SECTION 1.31	“Restricted ADRs\	4
	SECTION 1.32	“Restricted ADSs\	4
	SECTION 1.33	“Restricted Securities”	4
	SECTION 1.34	“Restricted Shares\	4
	SECTION 1.35	“Securities Act”	4
	SECTION 1.36	“Share(s)”	4
	SECTION 1.37	“United States” or “U.S.”	5
ARTICLE II.	APPOINTMENT OF DEPOSITARY; FORM OF RECEIPT; DEPOSIT OF SHARES; EXECUTION AND DELIVERY, TRANSFER AND SURRENDER OF RECEIPTS		5
	SECTION 2.1	Appointment of Depositary	5
	SECTION 2.2	Form and Transferability of Receipts	5
	SECTION 2.3	Deposits	6
	SECTION 2.4	Execution and Delivery of Receipts	8
	SECTION 2.5	Transfer of Receipts; Combination and Split-up of Receipts	8
	SECTION 2.6	Surrender of Receipts and Withdrawal of Deposited Securities	9
	SECTION 2.7	Limitations on Execution and Delivery, Transfer, etc. of Receipts; Suspension of Delivery, Transfer, etc.	10
	SECTION 2.8	Lost Receipts, etc.	11
	SECTION 2.9	Cancellation and Destruction of Surrendered Receipts	11
	SECTION 2.10	Maintenance of Records	11

ARTICLE III.	CERTAIN OBLIGATIONS OF HOLDERS AND BENEFICIAL OWNERS OF RECEIPTS	12	
	SECTION 3.1	Proofs, Certificates and Other Information	12
	SECTION 3.2	Liability for Taxes and Other Charges	13
	SECTION 3.3	Representations and Warranties on Deposit of Shares	13
	SECTION 3.4	Compliance with Information Requests	14
ARTICLE IV	THE DEPOSITED SECURITIES.	14	
	SECTION 4.1	Cash Distributions	14
	SECTION 4.2	Distribution in Shares	15
	SECTION 4.3	Elective Distributions in Cash or Shares	16
	SECTION 4.4	Distribution of Rights to Purchase Shares	16
	SECTION 4.5	Distributions Other Than Cash, Shares or Rights to Purchase Shares	18
	SECTION 4.6	Conversion of Foreign Currency	18
	SECTION 4.7	Fixing of Record Date	19
	SECTION 4.8	Voting of Deposited Securities	20
	SECTION 4.9	Changes Affecting Deposited Securities	21
	SECTION 4.10	Available Information	22
	SECTION 4.11	Reports	22
	SECTION 4.12	List of Holders	22
	SECTION 4.13	Taxation; Withholding	23
ARTICLE V.	THE DEPOSITARY, THE CUSTODIAN AND THE COMPANY	24	
	SECTION 5.1	Maintenance of Office and Transfer Books by the Registrar	24
	SECTION 5.2	Exoneration	25
	SECTION 5.3	Standard of Care	25
	SECTION 5.4	Resignation and Removal of the Depositary; Appointment of Successor Depositary	26
	SECTION 5.5	The Custodian	27
	SECTION 5.6	Notices and Reports	28
	SECTION 5.7	Issuance of Additional Shares, ADSs etc.	28
	SECTION 5.8	Indemnification	29
	SECTION 5.9	Fees and Charges of Depositary	30
	SECTION 5.10	Restricted Securities Owners/Ownership Restrictions	31
ARTICLE VI.	AMENDMENT AND TERMINATION	32	
	SECTION 6.1	Amendment/Supplement	32
	SECTION 6.2	Termination	33

ARTICLE VII.	MISCELLANEOUS		34
	SECTION 7.1	Counterparts	34
	SECTION 7.2	No Third-Party Beneficiaries	34
	SECTION 7.3	Severability	35
	SECTION 7.4	Holders and Beneficial Owners as Parties; Binding Effect	35
	SECTION 7.5	Notices	35
	SECTION 7.6	Governing Law and Jurisdiction	36
	SECTION 7.7	Assignment	37
	SECTION 7.8	Agents	37
	SECTION 7.9	Affiliates etc	38
	SECTION 7.10	Exclusivity	38
	SECTION 7.11	Compliance with U.S. Securities Laws	38
	SECTION 7.12	Titles	38
EXHIBIT A	40		
EXHIBIT B	49		

**AMENDED AND RESTATED SHAREHOLDERS AGREEMENT**

THIS AMENDED AND RESTATED SHAREHOLDERS AGREEMENT (this "Agreement") is entered into on December 23, 2020 (the "Effective Date"), by and among

1. Belite Bio, Inc, an exempted company organized under the laws of the Cayman Islands (the "Company"),
2. each of the Persons named on Schedule A-1 attached hereto (collectively, the "Principals", and each an "Principal"),
3. each of the Persons named on Schedule A-2 hereto (collectively the "Series A Investors", each a "Series A Investor"), and
4. each of the Persons named on Schedule A-3 hereto (collectively the "Series B Investors", each a "Series B Investor", together with the Series A Investors, the "Investors", and each an "Investor").

Each of the parties to this Agreement is referred to herein individually as a "Party" and collectively as the "Parties". Capitalized terms used herein without definition shall have the meanings set forth in the Purchase Agreement (as defined below).

**RECITALS**

- A The Company is engaged in the business of drug development (the "Business"). The Company seeks expansion capital to grow the Business and, correspondingly, seeks to secure an investment from the Investors, on the terms and conditions set forth herein.
- B Certain investors have agreed to purchase from the Company, and the Company has agreed to sell to the investors, certain Series B Preferred Shares (as defined below) of the Company on the terms and conditions set forth in the Series B Preferred Share Purchase Agreement dated as of the date hereof by and among the Company and the Investors (the "Purchase Agreement").
- C The Company, the Principals and the Series A Investors entered into certain Shareholders Agreement on January 21, 2020 (the "Prior Shareholders Agreement").
- D In connection with the purchase and sale of the Series B Preferred Shares pursuant to the Purchase Agreement, and as a condition thereto, the Company and the Investors agree to enter into this Agreement to amend and restate the Prior Shareholders Agreement in its entirety.
- E The Parties hereto constitute the required parties set forth in Section 15.11 of the Prior Shareholders Agreement and desire to amend and restate the Prior Shareholders Agreement in its entirety as set forth in this Agreement.

---

Shareholders Agreement

**WITNESSETH**

NOW, THEREFORE, in consideration of the foregoing recitals, the mutual promises hereinafter set forth, and other good and valuable consideration, the receipt and sufficiency of which are hereby acknowledged, the Parties intending to be legally bound hereto hereby agree as follows:

**1. Definitions.**

**1.1** Capitalized terms used and not otherwise defined herein shall have the meaning ascribed to them below:

“Accounting Standards” means International Financial Reporting Standards as promulgated from time to time by the International Accounting Standards Board (the “IASB”) (including, without limitation, standards and interpretations approved by the IASB and International Accounting Principles issued under previous constitutions thereof), together with the IASB’s pronouncements thereon from time to time, applied on a consistent basis.

“Affiliate” means, with respect to a Person, any other Person that, directly or indirectly, Controls, is Controlled by or is under common Control with such Person. In the case of an Investor, the term “Affiliate” also includes (v) any Controlling shareholder of the Investor, (w) any of such shareholder’s or Investors’ general partners or limited partners, (x) the fund manager managing such shareholder or Investor (and general partners, limited partners and officers thereof) and other funds managed by such fund manager, and (y) trusts Controlled by or for the benefit of any such Person referred to in (v), (w) or (x).

“Applicable Securities Laws” means (i) with respect to any offering of securities in the United States, or any other act or omission within that jurisdiction, the securities laws of the United States, including the Exchange Act and the Securities Act, and any applicable Law of any state of the United States, and (ii) with respect to any offering of securities in any jurisdiction other than the United States, or any related act or omission in that jurisdiction, the applicable Laws of that jurisdiction.

“Auditor” means the Person for the time being performing the duties of auditor of the Company (if any).

“Board” or “Board of Directors” means the board of directors of the Company.

“Business Day” means any day that is not a Saturday, Sunday, legal holiday or other day on which commercial banks are required or authorized by law to be closed in the PRC, Taiwan, or the United States.

“Charter Documents” means, with respect to a particular legal entity, the articles or certificate of incorporation, formation or registration (including, if applicable, certificates of change of name), memorandum of association, articles of association, bylaws, articles of organization, limited liability company agreement, trust deed, trust instrument, operating agreement, joint venture agreement, business license, or similar or other constitutive, governing, or charter documents, or equivalent documents, of such entity.

“Closing” has the meaning set forth in the Purchase Agreement.

“Code” means the United States Internal Revenue Code of 1986, as amended.

“Commission” means (i) with respect to any offering of securities in the United States, the Securities and Exchange Commission of the United States or any other federal agency at the time administering the Securities Act, and (ii) with respect to any offering of securities in a jurisdiction other than the United States, the regulatory body of the jurisdiction with authority to supervise and regulate the offering or sale of securities in that jurisdiction.

“Control” of a given Person means the power or authority, whether exercised or not, to direct the business, management and policies of such Person, directly or indirectly, whether through the ownership of voting securities, by contract or otherwise; provided, that such power or authority shall conclusively be presumed to exist upon possession of beneficial ownership or power to direct the vote of more than fifty percent (50%) of the votes entitled to be cast at a meeting of the members or shareholders of such Person or power to control the composition of a majority of the board of directors of such Person. The terms “Controlled” and “Controlling” have meanings correlative to the foregoing.

“Deemed Liquidation Event” has the meaning given to such term in the Memorandum and Articles.

“Director” means a director serving on the Board.

“Equity Securities” means, with respect to any Person that is a legal entity, any and all shares of capital stock, membership interests, units, profits interests, ownership interests, equity interests, registered capital, and other equity securities of such Person, and any right, warrant, option, call, commitment, conversion privilege, preemptive right or other right to acquire any of the foregoing, or security convertible into, exchangeable or exercisable for any of the foregoing.

“Exchange Act” means the United States Securities Exchange Act of 1934, as amended.

“Exempted Distribution” has the meaning given to such term in the Memorandum and Articles.

“Form F-1” means Form F-1 promulgated by the Commission under the Securities Act or any successor form or substantially similar form then in effect.

“Form F-3” means Form F-3 promulgated by the Commission under the Securities Act or any successor form or substantially similar form then in effect.

“Form S-1” means Form S-1 promulgated by the Commission under the Securities Act or any successor form or substantially similar form then in effect.

“Form S-3” means Form S-3 promulgated by the Commission under the Securities Act or any successor form or substantially similar form then in effect.

“Governmental Authority” means any government of any nation or any federation, province or state or any other political subdivision thereof, any entity, authority or body exercising executive, legislative, judicial, regulatory or administrative functions of or pertaining to government, including any governmental authority, agency, department, board, commission or instrumentality of any country, or any political subdivision thereof, any court, tribunal or arbitrator, and any self-regulatory organization.

“Governmental Order” means any applicable order, ruling, decision, verdict, decree, writ, subpoena, mandate, precept, command, directive, consent, approval, award, judgment, injunction or other similar determination or finding by, before or under the supervision of any Governmental Authority.

“Group Company” means the Company, together with its Subsidiary, and “Group” refers to all of Group Companies collectively.

“Holders” means the holders of Registrable Securities who are parties to this Agreement from time to time, and their permitted transferees that become parties to this Agreement from time to time.

“Hong Kong” means the Hong Kong Special Administrative Region of the People’s Republic of China.

“Initiating Holders” means, with respect to a request duly made under Section 2.1 or Section 2.2 to Register any Registrable Securities, the Holders initiating such request.

“IPO” means the first firm underwritten registered public offering by the Company of its Ordinary Shares pursuant to a Registration Statement that is filed with and declared effective by either the Commission under the Securities Act or another Governmental Authority for a public offering in a jurisdiction other than the United States.

“Law” or “Laws” means any and all provisions of any applicable constitution, treaty, statute, law, regulation, ordinance, code, rule, or rule of common law, any governmental approval, concession, grant, franchise, license, agreement, directive, requirement, or other governmental restriction or any similar form of decision of, or determination by, or any formally issued written interpretation or administration of any of the foregoing by, any Governmental Authority, in each case as amended, and any and all applicable Governmental Orders.

“Majority Investors” means the holders of at least a majority of the voting power of the then issued and outstanding Preferred Shares (voting together as a single class and calculated on as-converted basis).

“Memorandum and Articles” means the Second Amended and Restated Memorandum of Association of the Company and the Second Amended and Restated Articles of Association of the Company, as each may be amended and/or restated from time to time.

“Ordinary Share Equivalents” means any Equity Security which is by its terms convertible into or exchangeable or exercisable for Ordinary Shares or other share capital of the Company, including without limitation, the Preferred Shares.

“Ordinary Shares” means the Company’s ordinary shares, par value US\$0.0001 per share.

“Person” means any individual, corporation, partnership, limited partnership, proprietorship, association, limited liability company, firm, trust, estate or other enterprise or entity.

“PRC” means the People’s Republic of China, but solely for the purposes of this Agreement, excluding Hong Kong, the Macau Special Administrative Region and the islands of Taiwan.

“Preferred Shares” means, collectively, the Series A Preferred Shares and the Series B Preferred Shares.

“Public Official” means any executive, official, or employee of a Governmental Authority, political party or member of a political party, political candidate; executive, employee or officer of a public international organization; or director, officer or employee or agent of a wholly owned or partially state-owned or controlled enterprise.



“Qualified IPO” has the meaning given to such term in the Memorandum and Articles.

“Registrable Securities” means (i) the Ordinary Shares issued or issuable upon conversion of the Preferred Shares, (ii) any Ordinary Shares of the Company issued or issuable as a dividend or other distribution with respect to, in exchange for, or in replacement of, the shares referenced in (i) herein, and (iii) any Ordinary Shares owned or hereafter acquired by the Investors; excluding in all cases, however, any of the foregoing sold by a Person in a transaction other than an assignment pursuant to Section 15.3. For purposes of this Agreement, Registrable Securities shall cease to be Registrable Securities when such Registrable Securities have been disposed of pursuant to an effective Registration Statement.

“Registration” means a registration effected by preparing and filing a Registration Statement and the declaration or ordering of the effectiveness of that Registration Statement; and the terms “Register” and “Registered” have meanings concomitant with the foregoing.

“Registration Statement” means a registration statement prepared on Form F-1, F-3, S-1, or S-3 under the Securities Act, or on any comparable form in connection with registration in a jurisdiction other than the United States.

“Securities Act” means the United States Securities Act of 1933, as amended.

“Series A Preferred Shares” means the Series A Preferred Shares of the Company, par value US\$0.0001 per share, with the rights and privileges as set forth in the Memorandum and Articles.

“Series B Preferred Shares” means the Series B Preferred Shares of the Company, par value US\$0.0001 per share, with the rights and privileges as set forth in the Memorandum and Articles.

“Shareholder” means a holder of any Shares.

“Shares” means the Ordinary Shares and the Preferred Shares.

“Share Sale” has the meaning set forth in the Memorandum and Articles.

“Subsidiary” means, with respect to any given Person, any other Person that is Controlled directly or indirectly by such given Person.

“Transaction Documents” has the meaning set forth in the Purchase Agreement.

“US” means the United States of America.

**1.2 Other Defined Terms.** The following terms shall have the meanings defined for such terms in the Sections set forth below:

Agreement	Preamble
Approved Sale	Section 9.1
Arbitration Notice	Section 15.5(i)
Business	Recitals
CFC	Section 14.4
Company	Preamble
Company Notice	Section 8.2(iii)(a)
Company Option Period	Section 8.2(ii)
Confidential Information	Section 14.3
Co-Sale Notice	Section 8.3(i)
Dispute	Section 15.5(i)
Drag Holders	Section 9.1
Effective Date	Preamble
ESOP	Section 7.3(i)
Exempt Registrations	Section 3.4
Exercising Shareholder	Section 8.2(iii)(c)
HKIAC	Section 15.5(ii)
HKIAC Rules	Section 15.5(ii)
Holding Company	Section 8.1(iv)
Investors	Preamble
New Securities	Section 7.3
Offeror	Section 9.1
Offered Shares	Section 8.2(i)
Option Period	Section 8.2(iii)(a)
Ordinary Directors	Section 12.1(i)
Participation Notice	Section 7.4(i)
Party	Preamble
Permitted Transferee	Section 8.5
Permitted Transferees	Section 8.5
PFIC	Section 14.5
Preemptive Right	Section 7.1
Principal	Preamble
Purchase Agreement	Preamble
Re-allotment Period	Section 8.2(iii)(c)
Rights Holder	Section 7.1
Second Notice	Section 8.2(iii)(c)
Selling Shareholder	Section 8.3(i)
Transfer	Section 8.1(i)
Transfer Notice	Section 8.2(i)
Transferor	Section 8.2(i)
Violation	Section 5.1(i)

**1.3 Interpretation.** For all purposes of this Agreement, except as otherwise expressly herein provided, (i) the terms defined in this Section 1 shall have the meanings assigned to them in this Section 1 and include the plural as well as the singular, (ii) all accounting terms not otherwise defined herein have the meanings assigned under the Accounting Standards, (iii) all references in this Agreement to designated “Sections” and other subdivisions are to the designated Sections and other subdivisions of the body of this Agreement, (iv) pronouns of either gender or neuter shall include, as appropriate, the other pronoun forms, (v) the words “herein,” “hereof” and “hereunder” and other words of similar import refer to this Agreement as a whole and not to any particular Section or other subdivision, (vi) all references in this Agreement to designated Schedules, Exhibits and Appendices are to the Schedules, Exhibits and Appendices attached to this Agreement, (vii) references to this Agreement, any other Transaction Documents and any other document shall be construed as references to such document as the same may be amended, supplemented or novated from time to time, (viii) the phrase “directly or indirectly” means directly, or indirectly through one or more intermediate Persons or through contractual or other arrangements, and “direct or indirect” has the correlative meaning, (ix) the term “voting power” refers to the number of votes attributable to the Shares (on an as-converted basis) in accordance with the terms of the Memorandum and Articles, (x) the headings used in this Agreement are used for convenience only and are not to be considered in construing or interpreting this Agreement, (xi) references to laws include any such law modifying, re-enacting, extending or made pursuant to the same or which is modified, re-enacted, or extended by the same or pursuant to which the same is made, and (xii) all references to dollars or to “US\$” are to currency of the United States of America and all references to RMB are to currency of the PRC (and each shall be deemed to include reference to the equivalent amount in other currencies).

**2. Demand Registration.**

**2.1 Registration Other Than on Form F-3 or Form S-3.** Subject to the terms of this Agreement, at any time or from time to time after the date that is six (6) months after the closing of the IPO, Holders holding twenty-five percent (25%) or more of the voting power of the then issued and outstanding Registrable Securities held by all Holders may request in writing that the Company effect a Registration on any internationally recognized exchange that is reasonably acceptable to such requesting Holders. Upon receipt of such a request, the Company shall (x) promptly give written notice of the proposed Registration to all other Holders and (y) as soon as practicable, use its commercially reasonable efforts to cause the Registrable Securities specified in the request, together with any Registrable Securities of any Holder who requests in writing to join such Registration within fifteen (15) days after the Company's delivery of written notice, to be Registered and/or qualified for sale and distribution in such jurisdiction as the Initiating Holders may request. The Company shall be obligated to consummate no more than three (3) Registrations pursuant to this [Section 2.1](#) that have been declared and ordered effective; provided that if the Registrable Securities sought to be included in the Registration pursuant to this [Section 2.1](#) are not fully included in the Registration for any reason other than solely due to the action or inaction of the Holders including Registrable Securities in such Registration, such Registration shall not be deemed to constitute one of the Registration rights granted pursuant to this [Section 2.1](#). The Company shall not be obligated to take any action to effect any Registration pursuant to this [Section 2.1](#) unless the aggregate proceeds from the offering that is the subject of the Registration exceeds US\$50,000,000 and at least 10% of the Registrable Securities then issued and outstanding shall participate in such Registration.

**2.2 Registration on Form F-3 or Form S-3.** The Company shall use its commercially reasonable efforts to qualify for registration on Form F-3 or Form S-3. Subject to the terms of this Agreement, if the Company qualifies for registration on Form F-3 or Form S-3 (or any comparable form for Registration in a jurisdiction other than the United States), Holders holding 10% or more of the voting power of the then issued and outstanding Registrable Securities held by all Holders may request the Company in writing to file, in any jurisdiction in which the Company has had a registered underwritten public offering, a Registration Statement on Form F-3 or Form S-3 (or any comparable form for Registration in a jurisdiction other than the United States), including without limitation any registration statement filed under the Securities Act providing for the registration of, and the sale on a continuous or a delayed basis by the Holders of, all of the Registrable Securities pursuant to Rule 415 under the Securities Act and/or any similar rule that may be adopted by the Commission. Upon receipt of such a request, the Company shall (i) promptly give written notice of the proposed Registration to all other Holders and (ii) as soon as practicable, use its commercially reasonable efforts to cause the Registrable Securities specified in the request, together with any Registrable Securities of any Holder who requests in writing to join such Registration within fifteen (15) days after the Company's delivery of written notice, to be Registered and qualified for sale and distribution in such jurisdiction. The Company shall be obligated to consummate no more than two (2) Registrations that have been declared and ordered effective within any twelve (12)-month period pursuant to this [Section 2.2](#); provided that if the Registrable Securities sought to be included in the Registration pursuant to this [Section 2.2](#) are not fully included in such Registration for any reason other than solely due to the action or inaction of the Holders including Registrable Securities in such Registration, such Registration shall not be deemed to constitute one of the Registration rights granted pursuant to this [Section 2.2](#). The Company shall not be obligated to take any action to effect any Registration pursuant to this [Section 2.2](#) unless the aggregate proceeds from the offering that is the subject of the Registration exceeds US\$50,000,000.

### 2.3 Right of Deferral.

(i) The Company shall not be obligated to Register or qualify Registrable Securities pursuant to this Section 2:

(1) if, within ten (10) days of the receipt of any request of the Holders to Register any Registrable Securities under Section 2.1 or Section 2.2, the Company gives notice to the Initiating Holders of its bona fide intention to effect the filing for its own account of a Registration Statement of Ordinary Shares within sixty (60) days of receipt of that request; provided, that the Company is actively employing in good faith its commercially reasonable efforts to cause that Registration Statement to become effective within sixty (60) days of receipt of that request; provided, further, that the Holders are entitled to join such Registration in accordance with Section 3 (other than an Exempt Registration);

(2) during the period starting with the date of filing by the Company of, and ending six (6) months following the effective date of any Registration Statement pertaining to Ordinary Shares of the Company other than an Exempt Registration; provided, that the Holders are entitled to join such Registration in accordance with Section 3;

(3) in any jurisdiction in which the Company would be required to execute a general consent to service of process in effecting such Registration or qualification, unless the Company is already subject to service of process in such jurisdiction; or

(4) with respect to the registration on Form F-3 or Form S-3 (or any comparable form for Registration in a jurisdiction other than the United States), if Form F-3 or Form S-3 (or any comparable form for Registration in a jurisdiction other than the United States) (as the case may be) is not available for such offering by the Holders, or if the Holders, together with the holders of any other securities of the Company entitled to inclusion in such registration, propose to sell Registrable Securities and such other securities (if any) at an aggregate price to the public of less than US\$50,000,000.

(ii) If, after receiving a request from Holders pursuant to Section 2.1 or Section 2.2 hereof, the Company furnishes to the Holders a certificate signed by the chief executive officer of the Company stating that, in the good faith judgment of the Board, it would be materially detrimental to the Company or its members for a Registration Statement to be filed in the near future, then the Company shall have the right to defer such filing for a period during which such filing would be materially detrimental, provided, that the Company may not utilize this right for more than ninety (90) days on any one occasion or more than once during any twelve (12) month period; provided, further, that the Company may not Register any other its securities during such period (except for Exempt Registrations).

**2.4 Underwritten Offerings.** If, in connection with a request to Register Registrable Securities under Section 2.1 or Section 2.2, the Initiating Holders seek to distribute such Registrable Securities in an underwritten offering, they shall so advise the Company as a part of the request, and the Company shall include such information in the written notice to the other Holders described in Section 2.1 and Section 2.2. In such event, the right of any Holder to include its Registrable Securities in such Registration shall be conditioned upon such Holder's participation in such underwritten offering and the inclusion of such Holder's Registrable Securities in the underwritten offering (unless otherwise mutually agreed by the Initiating Holders and such Holder) to the extent provided herein. All Holders proposing to distribute their securities through such underwritten offering shall enter into an underwriting agreement in customary form with the underwriter or underwriters of internationally recognized standing selected for such underwritten offering by the Company and reasonably acceptable to the holders of at least a majority of the voting power of all Registrable Securities proposed to be included in such Registration. Notwithstanding any other provision of this Agreement, if the managing underwriter advises the Company that marketing factors (including without limitation the aggregate number of securities requested to be Registered, the general condition of the market, and the status of the Persons proposing to sell securities pursuant to the Registration) require a limitation of the number of Registrable Securities to be underwritten in a Registration pursuant to Section 2.1 or Section 2.2, the underwriters may exclude the Registrable Securities requested to be Registered but only after first excluding all other Equity Securities from the Registration and underwritten offering and so long as the number of shares to be included in the Registration on behalf of the non-excluded Holders is allocated among all Holders in proportion, as nearly as practicable, to the respective amounts of Registrable Securities requested by such Holders to be included; provided that any Initiating Holder shall have the right to withdraw its request for Registration from the underwriting by written notice to the Company and the underwriters delivered at least ten (10) days prior to the effective date of the Registration Statement, and such withdrawal request for Registration shall not be deemed to constitute one of the Registration rights granted pursuant to Section 2.1 or Section 2.2, as the case may be. If any Holder disapproves the terms of any underwriting, the Holder may elect to withdraw therefrom by written notice to the Company and the underwriters delivered at least ten (10) days prior to the effective date of the Registration Statement. Any Registrable Securities excluded or withdrawn from such underwritten offering shall be withdrawn from the Registration. To facilitate the allocation of shares in accordance with the above provisions, the Company or the underwriters may round the number of shares allocated to a Holder to the nearest one hundred (100) shares.

**3. Piggyback Registrations.**

**3.1 Registration of the Company's Securities.** Subject to the terms of this Agreement, if the Company proposes to Register for its own account any of its Equity Securities, or for the account of any holder (other than a Holder) of Equity Securities any of such holder's Equity Securities, in connection with the public offering of such securities (except for Exempt Registrations), the Company shall promptly give each Holder written notice of such Registration and, upon the written request of any Holder given within fifteen (15) days after delivery of such notice, the Company shall use its commercially reasonable efforts to include in such Registration any Registrable Securities thereby requested to be Registered by such Holder. If a Holder decides not to include all or any of its Registrable Securities in such Registration by the Company, such Holder shall nevertheless continue to have the right to include any Registrable Securities in any subsequent Registration Statement or Registration Statements as may be filed by the Company, all upon the terms and conditions set forth herein.

**3.2 Right to Terminate Registration.** The Company shall have the right to terminate or withdraw any Registration initiated by it under Section 3.1 prior to the effectiveness of such Registration, whether or not any Holder has elected to participate therein. The expenses of such withdrawn Registration shall be borne by the Company in accordance with Section 4.3.

**3.3 Underwriting Requirements.**

(i) In connection with any offering involving an underwriting of the Company's Equity Securities, the Company shall not be required to Register the Registrable Securities of a Holder under this Section 3 unless such Holder's Registrable Securities are included in the underwritten offering and such Holder enters into an underwriting agreement in customary form with the underwriter or underwriters of internationally recognized standing selected by the Company and setting forth such terms for the underwritten offering as have been agreed upon between the Company and the underwriters. In the event the underwriters advise Holders seeking Registration of Registrable Securities pursuant to this Section 3 in writing that market factors (including the aggregate number of Registrable Securities requested to be Registered, the general condition of the market, and the status of the Persons proposing to sell securities pursuant to the Registration) require a limitation of the number of Registrable Securities to be underwritten, the underwriters may exclude all or such portion of the Registrable Securities which were requested to be Registered, but only after first excluding all other Equity Securities (except for securities sold for the account of the Company) from the Registration and underwriting and so long as the Registrable Securities to be included in such Registration on behalf of any non-excluded Holders are allocated among all Holders in proportion, as nearly as practicable, to the respective amounts of Registrable Securities requested by such Holders to be included. To facilitate the allocation of shares in accordance with the above provisions, the Company or the underwriters may round the number of shares allocated to a Holder to the nearest one hundred (100) shares.

(ii) If any Holder disapproves the terms of any underwriting, the Holder may elect to withdraw therefrom by written notice to the Company and the underwriters delivered at least ten (10) days prior to the effective date of the Registration Statement. Any Registrable Securities excluded or withdrawn from the underwritten offering shall be withdrawn from the Registration.

**3.4 Exempt Registrations.** The Company shall have no obligation to Register any Registrable Securities under this Section 3 in connection with a Registration by the Company (i) relating solely to the sale of securities to participants in a Company share plan, (ii) relating to a corporate reorganization or other transaction under Rule 145 of the Securities Act (or comparable provision under the Laws of another jurisdiction, as applicable), (iii) on any form that does not include substantially the same information as would be required to be included in a registration statement covering the sale of the Registrable Securities and does not permit secondary sales, or (iv) relating to a registration in which the only Ordinary Shares being registered are Ordinary Shares issuable upon conversion of debt securities that are also being registered (collectively, "Exempt Registrations").

**4. Registration Procedures.**

**4.1 Registration Procedures and Obligations.** Whenever required under this Agreement to effect the Registration of any Registrable Securities held by the Holders, the Company shall, as expeditiously as reasonably possible:

(i) Prepare and file with the Commission a Registration Statement with respect to those Registrable Securities and use its commercially reasonable efforts to cause that Registration Statement to become effective, and, upon the request of the Holders holding at least two thirds in voting power of the Registrable Securities Registered thereunder, keep the Registration Statement effective until the distribution thereunder has been completed;

(ii) Prepare and file with the Commission amendments and supplements to that Registration Statement and the prospectus used in connection with the Registration Statement as may be necessary to comply with the provisions of Applicable Securities Laws with respect to the disposition of all securities covered by the Registration Statement;

(iii) Furnish to the Holders the number of copies of a prospectus, including a preliminary prospectus, required by Applicable Securities Laws, and any other documents as they may reasonably request in order to facilitate the disposition of Registrable Securities owned by them;

(iv) Use its commercially reasonable efforts to Register and qualify the securities covered by the Registration Statement under the Applicable Securities Laws, as reasonably requested by the Holders, provided, that the Company shall not be required to qualify to do business or file a general consent to service of process in any such jurisdictions;

(v) In the event of any underwritten public offering, enter into and perform its obligations under an underwriting agreement, in customary form, with the managing underwriter(s) of the offering;

(vi) Promptly notify each Holder of Registrable Securities covered by the Registration Statement at any time when a prospectus relating thereto is required to be delivered under Applicable Securities Laws of (a) the issuance of any stop order by the Commission, or (b) the happening of any event or the existence of any condition as a result of which any prospectus included in the Registration Statement, as then in effect, includes an untrue statement of a material fact or omits to state a material fact required to be stated therein or necessary to make the statements therein not misleading in the light of the circumstances under which they were made, or if in the opinion of counsel for the Company it is necessary to supplement or amend such prospectus to comply with law, and at the request of any such Holder promptly prepare and furnish to such Holder a reasonable number of copies of a supplement to or an amendment of such prospectus as may be necessary so that, as thereafter delivered to the purchasers of such securities, such prospectus shall not include an untrue statement of a material fact or omit to state a material fact required to be stated therein or necessary to make the statements therein not misleading in light of the circumstances under which they were made or such prospectus, as supplemented or amended, shall comply with law;

(vii) Furnish, at the request of any Holder requesting Registration of Registrable Securities pursuant to this Agreement, on the date that such Registrable Securities are delivered for sale in connection with a Registration pursuant to this Agreement, (A) an opinion, dated the date of the sale, of the counsel representing the Company for the purposes of the Registration, in form and substance as is customarily given to underwriters in an underwritten public offering; and (B) comfort letters dated as of (x) the effective date of the final registration statement covering such Registrable Securities, and (y) the closing date of the sale of the Registrable Securities, from the independent certified public accountants of the Company, in form and substance as is customarily given by independent certified public accountants to underwriters in an underwritten public offering, addressed to the underwriters;

(viii) Otherwise comply with all applicable rules and regulations of the Commission to the extent applicable to the applicable registration statement and use its commercially reasonable efforts to make generally available to its security holders (or otherwise provide in accordance with Section 11(a) of the Securities Act) an earnings statement satisfying the provisions of Section 11(a) of the Act, no later than forty-five (45) days after the end of a twelve (12) month period (or ninety (90) days, if such period is a fiscal year) beginning with the first month of the Company's first fiscal quarter commencing after the effective date of such registration statement, which statement shall cover such twelve (12) month period, subject to any proper and necessary extensions;

(ix) Provide a transfer agent and registrar for all Registrable Securities Registered pursuant to the Registration Statement and, where applicable, a number assigned by the Committee on Uniform Securities Identification Procedures for all those Registrable Securities, in each case not later than the effective date of the Registration; and

(x) Take all reasonable action necessary to list the Registrable Securities on the primary exchange on which the Company's securities are then traded or, in connection with a Qualified IPO, the primary exchange on which the Company's securities will be traded.

**4.2 Information from Holder.** It shall be a condition precedent to the obligations of the Company to take any action pursuant to this Agreement with respect to the Registrable Securities of any selling Holder that such Holder shall furnish to the Company such information regarding itself, the Registrable Securities held by it, and the intended method of disposition of such securities as shall be required to effect the Registration of such Holder's Registrable Securities.

**4.3 Expenses of Registration.** All expenses, other than the underwriting discounts and selling commissions applicable to the sale of Registrable Securities pursuant to this Agreement (which shall be borne by the Holders requesting Registration on a pro rata basis in proportion to their respective numbers of Registrable Securities sold in such Registration), incurred in connection with Registrations, filings or qualifications pursuant to this Agreement, including (without limitation) all Registration, filing and qualification fees, printers' and accounting fees, fees and disbursements of counsel for the Company and reasonable fees and disbursement of one counsel for all selling Holders, shall be borne by the Company. The Company shall not, however, be required to pay for any expenses of any Registration proceeding begun pursuant to Section 2.1 or Section 2.2 of this Agreement if the Registration request is subsequently withdrawn at the request of the Holders holding at least two thirds of the voting power of the Registrable Securities requested to be Registered by all Holders in such Registration (in which case all participating Holders shall bear such expenses pro rata based upon the number of Registrable Securities that were to be thereby Registered in the withdrawn Registration) unless the Holders of at least two thirds of the voting power of the Registrable Securities then issued and outstanding agree that such registration constitutes the use by the Holders of one (1) demand registration pursuant to Section 2.1 (in which case such registration shall also constitute the use by all Holders of Registrable Securities of one (1) such demand registration); provided, however, that if at the time of such withdrawal, the Holders have learned of a material adverse change in the condition, business or prospects of the Company from that known to the Holders at the time of their request and have withdrawn the request with reasonable promptness following disclosure by the Company of such material adverse change, then the Holders shall not be required to pay any of such expenses and the Company shall pay any and all such expenses.



**5. Registration-Related Indemnification.**

**5.1 Company Indemnity.**

(i) To the maximum extent permitted by Law, the Company will indemnify and hold harmless each Holder, such Holder's partners, officers, directors, shareholders, members, and legal counsel, any underwriter (as defined in the Securities Act) and each Person, if any, who controls (as defined in the Securities Act) such Holder or underwriter, against any losses, claims, damages or liabilities (joint or several) to which they may become subject under Laws which are applicable to the Company and relate to action or inaction required of the Company in connection with any Registration, qualification, or compliance, insofar as such losses, claims, damages, or liabilities (or actions in respect thereof) arise out of or are based upon any of the following statements, omissions or violations (each a "Violation"): (a) any untrue statement or alleged untrue statement of a material fact contained in such Registration Statement, on the effective date thereof (including any preliminary prospectus or final prospectus contained therein or any amendments or supplements thereto), (b) the omission or alleged omission to state in the Registration Statement, on the effective date thereof (including any preliminary prospectus or final prospectus contained therein or any amendments or supplements thereto), a material fact required to be stated therein or necessary to make the statements therein not misleading, or (c) any violation or alleged violation by the Company of Applicable Securities Laws, or any rule or regulation promulgated under Applicable Securities Laws. The Company will reimburse, as incurred, each such Holder, underwriter or controlling person for any legal or other expenses reasonably incurred by them in connection with investigating or defending any such loss, claim, damage, liability or action.

(ii) The indemnity agreement contained in this Section 5.1 shall not apply to amounts paid in settlement of any such loss, claim, damage, liability or action if such settlement is effected without the consent of the Company (which consent shall not be unreasonably withheld or delayed), nor shall the Company be liable in any such case for any such loss, claim, damage, liability or action to the extent that it arises solely out of or is solely based upon a Violation that occurs in reliance upon and in conformity with written information furnished for use in connection with such Registration by any such Holder, such Holder's partners, officers, directors, and legal counsel, any underwriter (as defined in the Securities Act) and each Person, if any, who controls (as defined in the Securities Act) such Holder or underwriter. Further, the foregoing indemnity agreement with respect to any preliminary prospectus shall not inure to the benefit of any Holder or other aforementioned person, or any person controlling such Holder, from whom the person asserting any such losses, claims, damages or liabilities purchased shares in the offering, if a copy of the most current prospectus was not sent or given by or on behalf of such Holder or other aforementioned person to such person, if required by law to have been so delivered, at or prior to the written confirmation of the sale of the shares to such person, and if the prospectus (as so amended or supplemented) would have cured the defect giving rise to such loss, claim, damage or liability.

## 5.2 Holder Indemnity.

(i) To the maximum extent permitted by Law, each selling Holder that has included Registrable Securities in a Registration will, severally and not jointly, indemnify and hold harmless the Company, its directors and officers, any other Holder selling securities in connection with such Registration, any underwriter (as defined in the Securities Act) and each Person, if any, who controls (within the meaning of the Securities Act) the Company, such underwriter or other Holder, against any losses, claims, damages or liabilities (joint or several) to which any of the foregoing persons may become subject, under Applicable Securities Laws, or any rule or regulation promulgated under Applicable Securities Laws, insofar as such losses, claims, damages or liabilities (or actions in respect thereto) arise out of or are based upon any Violation, in each case to the extent (and only to the extent) that such Violation occurs solely in reliance upon and in conformity with written information furnished by such Holder for use in connection with such Registration; and each such Holder will reimburse, as incurred, any Person intended to be indemnified pursuant to this [Section 5.2](#), for any legal or other expenses reasonably incurred by such Person in connection with investigating or defending any such loss, claim, damage, liability or action. No Holder's liability under this [Section 5.2](#) (when combined with any amounts paid by such Holder pursuant to [Section 5.4](#)) shall exceed the net proceeds received by such Holder from the offering of securities made in connection with that Registration.

(ii) The indemnity contained in this [Section 5.2](#) shall not apply to amounts paid in settlement of any such loss, claim, damage, liability or action if such settlement is effected without the consent of the Holder (which consent shall not be unreasonably withheld or delayed).

**5.3 Notice of Indemnification Claim.** Promptly after receipt by an indemnified party under [Section 5.1](#) or [Section 5.2](#) of notice of the commencement of any action (including any governmental action), such indemnified party will, if a claim in respect thereof is to be made against any indemnifying party under [Section 5.1](#) or [Section 5.2](#), deliver to the indemnifying party a written notice of the commencement thereof and the indemnifying party shall have the right to participate in, and, to the extent the indemnifying party so desires, jointly with any other indemnifying party similarly noticed, to assume the defense thereof with counsel mutually satisfactory to the indemnifying parties. An indemnified party (together with all other indemnified parties that may be represented without conflict by one counsel) shall have the right to retain one separate counsel, with the reasonably incurred fees and expenses to be paid by the indemnifying party, if representation of such indemnified party by the counsel retained by the indemnifying party would be inappropriate due to actual or potential differing interests between such indemnified party and any other party represented by such counsel in such proceeding. The failure to deliver written notice to the indemnifying party within a reasonable time of the commencement of any such action, if prejudicial to its ability to defend such action, shall relieve such indemnifying party, to the extent so prejudiced, of any liability to the indemnified party under this [Section 5](#), but the omission to deliver written notice to the indemnifying party will not relieve it of any liability that it may have to any indemnified party otherwise than under this [Section 5](#). No indemnifying party, in the defense of any such claim or litigation, shall, except with the consent of each indemnified party, consent to entry of any judgment or enter into any settlement which does not include as an unconditional term thereof the giving by the claimant or the plaintiff to such indemnified party of a release from all liability in respect to such claim or litigation.

**5.4 Contribution.** If any indemnification provided for in Section 5.1 or Section 5.2 is held by a court of competent jurisdiction to be unavailable to an indemnified party with respect to any loss, liability, claim, damage or expense referred to herein, the indemnifying party, in lieu of indemnifying such indemnified party hereunder, shall contribute to the amount paid or payable by such indemnified party as a result of such loss, liability, claim, damage or expense in such proportion as is appropriate to reflect the relative fault of the indemnifying party, on the one hand, and of the indemnified party, on the other, in connection with the statements or omissions that resulted in such loss, liability, claim, damage or expense, as well as any other relevant equitable considerations. The relative fault of the indemnifying party and of the indemnified party shall be determined by reference to, among other things, whether the untrue or alleged untrue statement of a material fact or the omission to state a material fact relates to information supplied by the indemnifying party or by the indemnified party and the parties' relative intent, knowledge, access to information, and opportunity to correct or prevent such statement or omission; provided, however, that, in any such case: (A) no Holder will be required to contribute any amount (after combined with any amounts paid by such Holder pursuant to Section 5.2) in excess of the net proceeds to such Holder from the sale of all such Registrable Securities offered and sold by such Holder pursuant to such registration statement; and (B) no person or entity guilty of fraudulent misrepresentation (within the meaning of Section 11(f) of the Securities Act) will be entitled to contribution from any person or entity who was not guilty of such fraudulent misrepresentation.

**5.5 Underwriting Agreement.** To the extent that the provisions on indemnification and contribution contained in the underwriting agreement entered into in connection with the underwritten public offering are in conflict with the foregoing provisions, the provisions in the underwriting agreement shall control.

**5.6 Survival.** The obligations of the Company and Holders under this Section 5 shall survive the completion of any offering of Registrable Securities in a Registration Statement under this Agreement, regardless of the expiration of any statutes of limitation or extensions of such statutes.

**6. Additional Registration-Related Undertakings.**

**6.1 Reports under the Exchange Act.** With a view to making available to the Holders the benefits of Rule 144 promulgated under the Securities Act and any comparable provision of any Applicable Securities Laws that may at any time permit a Holder to sell securities of the Company to the public without Registration or pursuant to a Registration on Form F-3 or Form S-3 (or any comparable form in a jurisdiction other than the United States), the Company agrees to:

(i) make and keep public information available, as those terms are understood and defined in Rule 144 (or comparable provision, if any, under Applicable Securities Laws in any jurisdiction where the Company's securities are listed), at all times following ninety (90) days after the effective date of the first Registration under the Securities Act filed by the Company for an offering of its securities to the general public;

(ii) file with the Commission in a timely manner all reports and other documents required of the Company under all Applicable Securities Laws; and

(iii) at any time following ninety (90) days after the effective date of the first Registration under the Securities Act filed by the Company for an offering of its securities to the general public by the Company, promptly furnish to any Holder holding Registrable Securities, upon request (a) a written statement by the Company that it has complied with the reporting requirements of all Applicable Securities Laws at any time after it has become subject to such reporting requirements or, at any time after so qualified, that it qualifies as a registrant whose securities may be resold pursuant to Form F-3 or Form S-3 (or any form comparable thereto under Applicable Securities Laws of any jurisdiction where the Company's securities are listed), (b) a copy of the most recent annual or quarterly report of the Company and such other reports and documents as filed by the Company with the Commission, and (c) such other information as may be reasonably requested in availing any Holder of any rule or regulation of the Commission, that permits the selling of any such securities without Registration or pursuant to Form F-3 or Form S-3 (or any form comparable thereto under Applicable Securities Laws of any jurisdiction where the Company's Securities are listed).

**6.2 Limitations on Subsequent Registration Rights.** From and after the date of this Agreement, the Company shall not, without the written consent of holders of at least a majority of the voting power of the then issued and outstanding Registrable Securities held by all Holders (calculated on an as-converted to Ordinary Share basis), enter into any agreement with any holder or prospective holder of any Equity Securities of the Company that would allow such holder or prospective holder (i) to include such Equity Securities in any Registration filed under Section 2 or Section 3, unless under the terms of such agreement such holder or prospective holder may include such Equity Securities in any such Registration only to the extent that the inclusion of such Equity Securities will not reduce the amount of the Registrable Securities of the Holders that are included, (ii) to demand Registration of their Equity Securities, or (iii) cause the Company to include such Equity Securities in any Registration filed under Section 2 or Section 3 hereof on a basis *pari passu* with or more favorable to such holder or prospective holder than is provided to the Holders of Registrable Securities.

**6.3 "Market Stand-Off" Agreement.** Each holder of Registrable Securities agrees, if so required by the managing underwriter(s), that it will not during the period commencing on the date of the final prospectus relating to the Company's IPO and ending on the date specified by the Company and the managing underwriter (such period not to exceed one hundred eighty (180) days from the date of such final prospectus, as may be extended in line with customary market practice, by up to a maximum of thirty two (32) days, to accommodate regulatory restrictions on (i) the publication or other distribution of research reports and (ii) analyst recommendations and opinions) (i) lend, offer, pledge, hypothecate, hedge, sell, make any short sale of, loan, contract to sell, sell any option or contract to purchase, purchase any option or contract to sell, grant any option, right or warrant to purchase, or otherwise transfer or dispose of, directly or indirectly, any Equity Securities of the Company owned immediately prior to the date of the final prospectus relating to the IPO (other than those included in such offering), or (ii) enter into any swap or other arrangement that transfers to another, in whole or in part, any of the economic consequences of ownership of such Equity Securities, whether any such transaction described in clause (i) or (ii) above is to be settled by delivery of Equity Securities of the Company or such other securities, in cash or otherwise; provided, that (a) the forgoing provisions of this Section shall not apply to the sale of any securities of the Company to an underwriter pursuant to any underwriting agreement, and shall not be applicable to any Holder unless all directors, officers and all other holders of at least one percent (1%) of the issued and outstanding share capital of the Company (calculated on an as-converted to Ordinary Share basis) must be bound by restrictions at least as restrictive as those applicable to any such Holder pursuant to this Section, (y) this Section shall not apply to a Holder to the extent that any other Person subject to substantially similar restrictions is released in whole or in part, and (z) the lockup agreements shall permit a Holder to transfer their Registrable Securities to their respective Affiliates so long as the transferees enter into the same lockup agreement. The Investors agree to execute and deliver to the underwriters a lock-up agreement containing substantially similar terms and conditions as those contained herein. The underwriters in connection with the Company's IPO are intended third party beneficiaries of this Section and shall have the right, power and authority to enforce the provisions hereof as though they were a party hereto. In order to enforce the foregoing covenant, the Company may place restrictive legends on the certificates and impose stop-transfer instructions with respect to the Registrable Securities of each shareholder (and the shares or securities of every other Person subject to the foregoing restriction) until the end of such period.

**6.4 Termination of Registration Rights.** The registration rights set forth in Section 2 and Section 3 of this Agreement shall terminate on the earlier of (i) the date that is five (5) years from the date of closing of a Qualified IPO, (ii) with respect to any Holder, the date on which such Holder may sell all of such Holder's Registrable Securities under Rule 144 of the Securities Act in any ninety (90)-day period.

**6.5 Exercise of Ordinary Share Equivalents.** Notwithstanding anything to the contrary provided in this Agreement, the Company shall have no obligation to Register Registrable Securities which, if constituting Ordinary Share Equivalents, have not been exercised, converted or exchanged, as applicable, for Ordinary Shares as of the effective date of the applicable Registration Statement, but the Company shall cooperate and facilitate any such exercise, conversion or exchange as requested by the applicable Holder.

**6.6 Intent.** The terms of Sections 2 through 6 are drafted primarily in contemplation of an offering of securities in the United States of America. The parties recognize, however, the possibility that securities may be qualified or registered for offering to the public in a jurisdiction other than the United States of America where registration rights have significance or that the Company might effect an offering in the United States of America in the form of American Depositary Receipts or American Depositary Shares. Accordingly:

(i) it is their intention that, whenever this Agreement refers to a Law, form, process or institution of the United States of America but the parties wish to effectuate qualification or registration in a different jurisdiction where registration rights have significance, reference in this Agreement to the Laws or institutions of the United States shall be read as referring, *mutatis mutandis*, to the comparable Laws or institutions of the jurisdiction in question; and

(ii) it is agreed that the Company will not undertake any listing of American Depositary Receipts, American Depositary Shares or any other security derivative of the Ordinary Shares unless arrangements have been made reasonably satisfactory to the Majority Investors to ensure that the spirit and intent of this Agreement will be realized and that the Company is committed to take such actions as are necessary such that the Holders will enjoy rights corresponding to the rights hereunder to sell their Registrable Securities in a public offering in the United States of America as if the Company had listed Ordinary Shares in lieu of such derivative securities.

**7. Preemptive Right.**

**7.1 General.** The Company hereby grants to each holder of Preferred Shares and Ordinary Shares (“Rights Holder”) the right of first refusal to purchase such Rights Holder’s Pro Rata Share (as defined below) (and any oversubscription, as provided below), of all (or any part) of any New Securities (as defined below) that the Company may from time to time issue after the date of this Agreement (the “Preemptive Right”).

**7.2 Pro Rata Share.** A Rights Holder’s “Pro Rata Share” for purposes of the Preemptive Rights is the ratio of (a) the number of Ordinary Shares (including Preferred Shares on an as-converted basis) held by such Rights Holder, to (b) the total number of Ordinary Shares (including Preferred Shares on an as-converted basis) then issued and outstanding immediately prior to the issuance of New Securities giving rise to the Preemptive Rights.

**7.3 New Securities.** For purposes hereof, “New Securities” shall mean any Equity Securities of the Company issued after the Closing, except for:

- (i) Ordinary Shares (as adjusted in connection with share splits or share consolidation, reclassification or other similar event) and/or options or warrants therefor issued to employees, officers, directors, contractors, advisors or consultants of the Group Companies pursuant to the Company’s employee share option plans (“ESOP”) duly approved by the Board in accordance with Section 13;
- (ii) any Equity Securities of the Company issued in connection with any share split, share dividend, reclassification or other similar event;
- (iii) any Ordinary Shares issued pursuant to bona fide transactions with commercial lenders or lessors in connection with loans, credit arrangements, equipment financings or similar transactions, each such transaction having been approved by the Board;
- (iv) any Ordinary Shares issued pursuant to bona fide transactions with licensors, collaborators or strategic partners in connection with technology licensing, research, development or commercialization collaboration, strategic partnership or similar transactions, each such transaction having been approved by the Board;
- (v) any Equity Securities of the Company issued pursuant to the Qualified IPO;
- (vi) any Equity Securities of the Company issued pursuant to the acquisition of another corporation or entity by the Company by consolidation, merger, purchase of assets, or other reorganization in which the Company acquires, in a single transaction or series of related transactions, all or substantially all assets of such other corporation or entity, or fifty percent (50%) or more of the equity ownership or voting power of such other corporation or entity, in any case, duly approved in accordance with Section 13;
- (vii) any Ordinary Shares issued upon the conversion of the Preferred Shares; and
- (viii) any Series B Preferred Shares issued pursuant to the Purchase Agreement.

#### 7.4 Procedures.

(i) In the event that the Company proposes to undertake an issuance of New Securities (in a single transaction or a series of related transactions), it shall give to each Rights Holder written notice of its intention to issue New Securities (the "Participation Notice"), describing the amount and type of New Securities, the price and the general terms upon which the Company proposes to issue such New Securities. Each Rights Holder shall have ten (10) Business Days from the date of receipt of any such Participation Notice to agree in writing to purchase up to such Rights Holder's Pro Rata Share of such New Securities for the price and upon the terms and conditions specified in the First Participation Notice by giving written notice to the Company and stating therein the quantity of New Securities to be purchased (not to exceed such Rights Holder's Pro Rata Share). If any Rights Holder fails to so respond in writing within such ten (10) Business Day period, then such Rights Holder shall forfeit the right hereunder to purchase its Pro Rata Share of such New Securities, but shall not be deemed to forfeit any right with respect to any other issuance of New Securities. At the expiration of such ten (10) day period, the Company shall promptly notify each Rights Holder that elects to purchase or acquire all the shares available to it (each, a "Fully Exercising Investor") of any other Rights Holder's failure to do likewise. During the ten (10) day period commencing after the Company has given such notice, each Fully Exercising Investor may, by giving notice to the Company, elect to purchase or acquire, in addition to the number of shares specified above, up to that portion of the New Securities for which Rights Holders were entitled to subscribe but that were not subscribed for by the Rights Holders which is equal to the proportion that the Ordinary Shares issued and held, or issuable (directly or indirectly) upon conversion and/or exercise, as applicable, of Preferred Shares, by such Fully Exercising Investor bears to the Ordinary Shares issued and held, or issuable (directly or indirectly) upon conversion and/or exercise, as applicable, of the Preferred Shares then held, by all Fully Exercising Investors who wish to purchase such unsubscribed shares. The closing of any sale pursuant to this Section 7.4 shall occur within the later of ninety (90) days of the date that the Participation Notice is given and the date of initial sale of New Securities pursuant to Section 7.5.

**7.5 Failure to Exercise.** Upon the expiration of the Participation Period, the Company shall have ninety (90) days thereafter to complete the sale of the New Securities described in the Participation Notice with respect to which the Preemptive Rights hereunder were not exercised at the same or higher price and upon non-price terms not more favorable to the purchasers thereof than specified in the Participation Notice. In the event that the Company has not issued and sold such New Securities within such ninety (90) day period, then the Company shall not thereafter issue or sell any New Securities without again first offering such New Securities to the Rights Holders pursuant to this Section 7.

#### 8. Restriction on Transfers; Rights of First Refusal and Co-Sale Rights.

##### 8.1 Restriction on Transfers.

(i) **Principals.** A Principal shall not directly or indirectly sell, assign, transfer, pledge, hypothecate, or otherwise encumber or dispose of in any way or otherwise grant any interest or right with respect to ("Transfer") all or any part of any interest in any Equity Securities of the Company now or hereafter owned or held by such Principal unless Sections 8.2, 8.3 and 8.4 are complied with.

(ii) **Investors.** For the avoidance of doubt, Investors may freely Transfer any Equity Securities of the Company now or hereafter owned or held by them without limitation; provided that (i) no such Transfer shall result in any shares of the Company being transferred to or owned by, directly or indirectly, any competitor of the Company; (ii) such Transfer is effected in compliance with all applicable Laws and (iii) the transferee shall execute and deliver to the Company a deed of adherence or joinder becoming a party hereto as an "Investor" subject to the terms and conditions hereof (if not already so bound) upon and after such Transfer. The Company will update its register of members upon the consummation of any such permitted Transfer.

(iii) **Prohibited Transfers Void.** Any Transfer of Equity Securities of the Company not made in compliance with this Agreement shall be null and void as against the Company, shall not be recorded on the books of the Company and shall not be recognized by the Company or any other Party.

(iv) **No Indirect Transfers.** Each Principal agrees not to circumvent or otherwise avoid the transfer restrictions or intent thereof set forth in this Agreement, whether by holding the Equity Securities of the Company indirectly through another Person or by causing or effecting, directly or indirectly, the Transfer or issuance of any Equity Securities by any such Person, or otherwise. Any purported Transfer, sale or issuance of any Equity Securities of any company held by a Principal holding shares in the Company (the "Holding Company") in contravention of this Agreement shall be void and ineffective for any and all purposes and shall not confer on any transferee or purported transferee any rights whatsoever, and no Party (including without limitation, any Principal or Holding Company) shall recognize any such Transfer, sale or issuance.

## 8.2 Rights of First Refusal.

(i) **Transfer Notice.** If a Principal (a "Transferor") proposes to Transfer any Equity Securities of the Company or any interest therein to one or more third parties, then the Transferor shall give the Company and each Investor written notice of the Transferor's intention to make the Transfer (the "Transfer Notice"), which shall include (i) a description of the Equity Securities to be transferred (the "Offered Shares"), (ii) the identity and address of the prospective transferee and (iii) the consideration and the material terms and conditions upon which the proposed Transfer is to be made. The Transfer Notice shall certify that the Transferor has received a definitive offer from the prospective transferee and in good faith believes a binding agreement for the Transfer is obtainable on the terms set forth in the Transfer Notice. The Transfer Notice shall also include a copy of any written proposal, term sheet or letter of intent or other agreement relating to the proposed Transfer.

(ii) **Option of Company.** The Company shall have an option for a period of ten (10) days following receipt of the Transfer Notice (the "Company Option Period") to elect to purchase all or a portion of the Offered Shares, at the same price and subject to the same terms and conditions as described in the Transfer Notice, exercisable by written notice to the Transferor (with a copy to the Investors).

(iii) **Option of Investors.**

(a) If the Company does not timely elect to purchase all of the Offered Shares pursuant to clause (ii) above, then the Company shall deliver to each Investor written notice (the "Company Notice") thereof within ten (10) days after the expiration of the Company Option Period, and each such Investor shall have an option for a period of ten (10) days following receipt of the Company Notice (the "Option Period") to elect to purchase all or any portion of its respective Pro Rata Share of the remaining Offered Shares at the same price and subject to the same terms and conditions as described in the Transfer Notice, by notifying the Transferor and the Company in writing before expiration of the Option Period as to the number of such Offered Shares that it wishes to purchase.



(b) For the purposes of this Section 8.2(iii), an Investor's "Pro Rata Share" of such Offered Shares shall be equal to (i) the total number of such Offered Shares, multiplied by (ii) a fraction, the numerator of which shall be the aggregate number of Ordinary Shares held by such Investor on the date of the Transfer Notice (including all Preferred Shares held by such Investor on an as-converted to Ordinary Share basis) and the denominator of which shall be the total number of Ordinary Shares held by all Investors on such date (including all Preferred Shares held by such Investors on an as-converted to Ordinary Share basis).

(c) If any Investor fails to exercise its right to purchase its full Pro Rata Share of such Offered Shares, the Company shall deliver written notice thereof (the "Second Notice"), within five (5) days after the expiration of the Option Period, to the Transferor and to each Investor that elected to purchase its entire Pro Rata Share of the Offered Shares (an "Exercising Shareholder"). The Exercising Shareholders shall have a right of re-allotment, and may exercise an additional right to purchase such unpurchased Offered Shares by notifying the Transferor and the Company in writing within ten (10) days after receipt of the Second Notice (the "Re-allotment Period"); provided, however, that if the Exercising Shareholders desire to purchase in aggregate more than the number of such unpurchased Offered Shares, then such unpurchased Offered Shares will be allocated to the extent necessary among the Exercising Shareholders in accordance with their relative Pro Rata Shares.

(d) Subject to applicable securities Laws, each Investor shall be entitled to apportion Offered Shares to be purchased among its Affiliates, provided that such Investor notifies the Company and the Transferor in writing and such Affiliates shall execute and deliver such documents and take such other actions as may be necessary for such Affiliates to join in and be bound by the terms of this Agreement as an "Investor" (if not already a party hereto) upon and after such Transfer.

(iv) **Procedure.** If the Company or any Investor gives the Transferor notice that it desires to purchase Offered Shares, and, as the case may be, any re-allotment, then payment for the Offered Shares to be purchased shall be made by check (if agreeable to the Transferor), or by wire transfer in immediately available funds of the appropriate currency, against delivery of such Offered Shares to be purchased, at a place agreed to by the Transferor, the Company (if it is a purchaser) and all the Exercising Shareholders (if they are purchasers) and at the time of the scheduled closing thereof, but if they cannot agree, then at the principal executive offices of the Company on the thirtieth (30<sup>th</sup>) day after the Company's receipt of the Transfer Notice, unless such notice contemplated a later closing date with the prospective third party transferee or unless the value of the purchase price has not yet been established pursuant to Section 8.2(v), in which case the closing shall be on such later date or as provided in Section 8.2(v)(d). The Transferor shall have the right to terminate or withdraw any Transfer Notice and any intent to transfer Offered Shares at any time, whether or not any Investor has elected to purchase under this Section 8.2 any Offered Shares offered thereby. The Company will update its register of members upon the consummation of any such Transfer.

(v) **Valuation of Property.**

(a) Should the purchase price specified in the Transfer Notice be payable in property other than cash or evidences of indebtedness, the Company and/or the Investors, as applicable, shall have the right to pay the purchase price in the form of cash equal in amount to the fair market value of such property.

(b) If the Transferor, the Company (if it is a purchaser), and the Exercising Shareholders holding a majority of the Offered Shares elected to be purchased by all Exercising Shareholders (if they are purchasers) cannot agree on such cash value within the Option Period, the valuation shall be made by an appraiser of internationally recognized standing jointly selected by agreement of such groups or, if they cannot agree on an appraiser within the Option Period, each such group shall select an appraiser of internationally recognized standing and such appraisers shall designate another appraiser of internationally recognized standing, whose appraisal shall be determinative of such value.

(c) The cost of such appraisal (and the cost, if any, of securing the appointment thereof by the HKIAC council) shall be shared equally by the Transferor, on the one hand, and the purchasers pro rata based on the number of Offered Shares such purchaser is purchasing, on the other hand.

(d) If the value of the purchase price offered by the prospective transferee is not determined within 30 days following the Company's receipt of the Transfer Notice from the Transferor, the closing of the purchase of Offered Shares by the Company and/or the Exercising Shareholders shall be held on or prior to the fifth (5<sup>th</sup>) Business Day after such valuation shall have been made pursuant to this Section 8.2(v).

**8.3 Right of Co-Sale.**

(i) To the extent the Company and the Investors do not exercise their respective rights of first refusal under Section 8.2 as to all or any of the Offered Shares proposed to be sold by the Transferor to the third party transferee identified in the Transfer Notice, the Transferor shall give notice thereof to each Investor not exercising any right of first refusal pursuant to Section 8.2 (the "Co-Sale Notice") (specifying in such Co-Sale Notice the number of remaining Offered Shares as well as the number of Shares that such Investor would be eligible to include in such sale pursuant to its co-sale right hereunder, and each such Investor shall have the right to participate in such sale, to the third party transferee identified in the Transfer Notice, of the remaining Offered Shares not purchased pursuant to Section 8.2, on the same terms and conditions as specified in the Transfer Notice (but in no event less favorable than the terms and conditions offered to the Transferor) (and for the same consideration on an as converted to ordinary share basis) by notifying the Transferor in writing within ten (10) days following the date of the Co-Sale Notice (each such electing Investor, a "Selling Shareholder"). Such Selling Shareholder's notice to the Transferor shall indicate the number of Equity Securities the Selling Shareholder wishes to sell under its right to participate. To the extent one or more Investors exercise such right of participation in accordance with the terms and conditions set forth below, the number of Offered Shares that the Transferor may sell in the Transfer to the third party transferee identified in the Transfer Notice shall be correspondingly reduced.

(ii) The total number of Equity Securities that each Selling Shareholder may elect to sell shall be equal to the product of (i) the aggregate number of the remaining Offered Shares being transferred to the third party transferee identified in the Transfer Notice after giving effect to the exercise of all rights of first refusal pursuant to Section 8.2 hereof, multiplied by (ii) a fraction, the numerator of which is the number of Ordinary Shares (including Preferred Shares on an as-converted to Ordinary Share basis) owned by such Selling Shareholder on the date of the Transfer Notice and the denominator of which is the total number of Ordinary Shares (including Preferred Shares on an as-converted to Ordinary Share basis) owned by the Transferor and all Selling Shareholders.

(iii) Each Selling Shareholder shall effect its participation in the sale by promptly delivering to the Transferor for transfer to the prospective purchaser, before the applicable closing, one or more certificates, properly endorsed for transfer, which represent the type and number of Equity Securities which such Selling Shareholder elects to sell; provided, however that if the prospective third party purchaser objects to the delivery of Ordinary Share Equivalents in lieu of Ordinary Shares, such Selling Shareholder shall only deliver Ordinary Shares (and therefore shall convert any such Ordinary Share Equivalents into Ordinary Shares) and certificates corresponding to such Ordinary Shares, and the Company shall effect any such conversion concurrent with the actual transfer of such shares to the purchaser and contingent on such transfer.

(iv) The share certificate or certificates that a Selling Shareholder delivers to the Transferor pursuant to this Section 8.3 shall be transferred to the prospective purchaser in consummation of the sale of the Equity Securities pursuant to the terms and conditions specified in the Transfer Notice, and the Transferor shall concurrently therewith remit to such Selling Shareholder that portion of the sale proceeds to which such Selling Shareholder is entitled by reason of its participation in such sale. The Company will update its register of members upon the consummation of any such Transfer.

(v) To the extent that any prospective purchaser prohibits the participation by a Selling Shareholder exercising its co-sale rights hereunder in a proposed Transfer or otherwise refuses to purchase shares or other securities from a Selling Shareholder exercising its co-sale rights hereunder, the Transferor shall not sell to such prospective purchaser any Equity Securities unless and until, simultaneously with such sale, the Transferor shall purchase from such Selling Shareholder such shares or other securities that such Selling Shareholder would otherwise be entitled to sell to the prospective purchaser pursuant to its co-sale rights for the same consideration and on the same terms and conditions as the proposed transfer described in the Transfer Notice.

#### **8.4 Non-Exercise of Rights.**

(i) If the Company and the Investors do not elect to purchase all of the Offered Shares in accordance with Section 8.2, then, subject to the right of the Investors to exercise their rights to participate in the sale of Offered Shares within the time periods specified in Section 8.3, the Transferor shall have a period of sixty (60) days from the expiration of the Option Period in which to sell the remaining Offered Shares to the third party transferee identified in the Transfer Notice upon terms and conditions (including the purchase price) no more favorable to the purchaser than those specified in the Transfer Notice, so long as any such sale is effected in accordance with all applicable Laws. The Parties agree that each such transferee, prior to and as a condition to the consummation of any sale, shall execute and deliver to the Parties documents and other instruments assuming the obligations of such Transferor under this Agreement with respect to the Offered Shares, and the transfer shall not be effective and shall not be recognized by any Party until such documents and instruments are so executed and delivered.

(ii) In the event the Transferor does not consummate the sale of such Offered Shares to the third party transferee identified in the Transfer Notice within sixty (60) day period, the rights of the Investors under Section 8.2 and Section 8.3 shall be re-invoked and shall be applicable to each subsequent disposition of such Offered Shares by the Transferor until such rights lapse in accordance with the terms of this Agreement.

(iii) The exercise or non-exercise of the rights of the Investors under this Section 8 to purchase Equity Securities from a Transferor or participate in the sale of Equity Securities by a Transferor shall not adversely affect their rights to make subsequent purchases from the Transferor of Equity Securities or subsequently participate in sales of Equity Securities by the Transferor hereunder.

**8.5 Limitations to Rights of First Refusal and Co-Sale.** Subject to the requirements of applicable Law, the restrictions under Section 8.1 and the right of first refusal and right of co-sale of the Investors under Sections 8.2 and 8.3 shall not apply to (a) any sale of Equity Securities of the Company to the public pursuant to a Qualified IPO, (b) Transfer of any Equity Securities of the Company now or hereafter held by a Transferor to such Transferor's parents, children, spouse, or to a trustee, executor, or other fiduciary for the benefit of such Transferor or such Transferor's parents, children, spouse for bona fide estate planning purposes, and (c) Transfer of any Equity Securities of the Company now or hereafter held by an Transferor to its Affiliates (each such transferee pursuant to clause (b) above, a "Permitted Transferee", and collectively, the "Permitted Transferees"); provided, that (i) such Transfer is effected in compliance with all applicable Laws, (ii) respecting any transfer pursuant to clause (b) above, the Transferor has provided the Majority Investors reasonable evidence of the bona fide estate planning purposes for such transfer, and (iii) each such Permitted Transferee, prior to the completion of the Transfer, shall execute and deliver to the Company a deed of adherence or joinder becoming a party hereto as an "Investor" subject to the terms and conditions hereof (if not already so bound) assuming the obligations of such Transferor under this Agreement as a Transferor, with respect to the transferred Equity Securities; provided further, that the Transferor shall remain liable for any breach by such Permitted Transferee of any provision under this Agreement.

## **9. Drag-Along Rights.**

**9.1 Drag-Along Obligations.** On or after January 31, 2025, if more than 67% of holders of Preferred Shares (collectively, the "Drag Holders") approve in writing a proposed Deemed Liquidation Event, Share Sale or other sale of the Company, whether structured as a merger, reorganization, asset sale, share sale, sale of control of the Company, or otherwise at a valuation no less than US\$500,000,000 (the "Approved Sale"), to any Person that is not a Drag Holder or an Affiliate of any Drag Holder (the "Offeror"), then at the request of the Drag Holders the Company shall promptly notify in writing each other holder of Equity Securities of the Company and the material terms and conditions of such proposed Approved Sale, whereupon each such holder shall, in accordance with instructions received from the Company at the direction of the Drag Holders:

(i) Sell, at the same time as the Drag Holders sell to the Offeror, in the Approved Sale, all of its Equity Securities of the Company or the same percentage of its Equity Securities of the Company as the Drag Holders sell, on the same terms and conditions as were agreed to by the Drag Holders; provided, however, that such terms and conditions, including with respect to price paid or received per Equity Security of the Company, may differ as between different classes of Equity Securities of the Company in accordance with their relative liquidation preferences as set forth in Article 7.2 of the Memorandum and Articles and provided further that some holders may be given the right or opportunity to exchange or roll a portion of their Equity Securities of the Company for Equity Securities of the acquirer or an Affiliate thereof in the Approved Sale but in such event there shall be no obligation to afford such right or opportunity to all of such holders.

(ii) Vote all of its Equity Securities of the Company (a) in favor of such Approved Sale, (b) against any other consolidation, recapitalization, amalgamation, merger, sale of securities, sale of assets, business combination, or transaction that would interfere with, delay, restrict, or otherwise adversely affect such Approved Sale, and (c) against any action or agreement that would result in a breach of any covenant, representation or warranty or any other obligation or agreement of the Company under the definitive agreement(s) related to such Approved Sale or that could result in any of the conditions to the closing obligations under such agreement(s) not being fulfilled, and, in connection therewith, to be present (in person or by proxy) at all relevant meetings of the shareholders of the Company (or adjournments thereof) or to approve and execute all relevant written consents in lieu of a meeting.

(iii) Not exercise any dissenters' or appraisal rights under applicable law with respect to such Approved Sale.

(iv) Take all necessary actions in connection with the consummation of such Approved Sale as reasonably requested by the Drag Holders, including but not limited to the execution and delivery of any share transfer or other agreements prepared in connection with such Approved Sale, and the delivery, at the closing of such Approved Sale involving a sale of stock, of all certificates representing stock held or controlled by such holder, duly endorsed for transfer or accompanied by a duly executed share transfer form, or affidavits and indemnity undertakings with respect to lost certificates.

(v) Restructure such Approved Sale, as and if reasonably requested by the Drag Holders, as a merger, consolidation, restructuring or similar transaction, or a sale of all or substantially all of the assets of the Company, or otherwise.

**9.2 Other Provisions.** In the event that any such holder fails for any reason to take any of the foregoing actions after reasonable notice thereof, such holder hereby grants an irrevocable power of attorney and proxy to any Director approving the Approved Sale to take all necessary actions and execute and deliver all documents deemed by such Director to be reasonably necessary to effectuate the terms hereof. None of the transfer restrictions set forth in Section 8 or 9 of this Agreement shall apply in connection with an Approved Sale, notwithstanding anything contained to the contrary herein and therein.

**10. Legend.** Each existing or replacement certificate for Equity Securities of the Company now owned or hereafter acquired by a Party and their permitted transferees shall bear the following legend:

“THE SALE, PLEDGE, HYPOTHECATION, ASSIGNMENT OR TRANSFER OF THESE SECURITIES IS SUBJECT TO THE TERMS AND CONDITIONS OF A CERTAIN SHAREHOLDERS AGREEMENT BY AND BETWEEN THE SHAREHOLDER, THE COMPANY AND CERTAIN OTHER PARTIES THERETO, AS AMENDED AND RESTATED FROM TIME TO TIME. COPIES OF SUCH AGREEMENT MAY BE OBTAINED UPON WRITTEN REQUEST TO THE COMPANY.”

The Company may annotate its register of members with an appropriate, corresponding legend. At such time as Equity Securities are no longer subject to this Agreement, the Company shall, at the request of the holder of such Equity Securities, issue replacement certificates for such Equity Securities without such legend.

In order to ensure compliance with the terms of this Agreement, the Company may issue appropriate “stop transfer” instructions to its transfer agent, if any, and, if the Company acts as transfer agent for its own securities, it may make appropriate notations to the same effect in its own records.

**11. Information and Inspection Rights.**

**11.1 Delivery of Financial Statements.** The Company shall deliver to each Rights Holder who holds at least five percent (5%) in the share capital of the Company on fully-diluted basis the following documents or reports:

(i) within one hundred and twenty (120) days after the end of each fiscal year of the Company, a consolidated income statement and statement of cash flows for the Company for such fiscal year and a consolidated balance sheet for the Company as of the end of the fiscal year, all prepared in English and in accordance with the Accounting Standards consistently applied, such financial statements shall be audited and certified by independent public accountants selected by the Board of Directors if the Board of Directors determines that it is advisable for the Company to have such financial statements audited and certified;

(ii) within sixty (60) days of the end of each second quarter of a year, a consolidated unaudited income statement for the first six months of such year and a consolidated unaudited balance sheet for the Company as of the end of such six-month period, in accordance with the Accounting Standards consistently applied throughout the period (except for customary year-end adjustments and except for the absence of notes);

(iii) an annual business and financial plan for the following fiscal year prior to the beginning of such fiscal year in reasonable detail;

(iv) as soon as practicable, any other information reasonably requested by any such Rights Holder, provided that such requests shall not be more frequent than twice a year.

**11.2 Inspection Rights.** The Company covenants and agrees that each Rights Holder shall have the right, to reasonably inspect the books and records of each Group Company at any time during regular working hours and in a manner so as not to interfere with the normal business operations of the Group Company on reasonable prior notice to such Group Company, provided that such Rights Holder shall bear the costs for its own representatives and that such inspection shall not be more frequent than twice a year.

**12. Election of Directors.**

**12.1 Board of Directors.**

(i) The Company shall have, and the Parties hereto agree to cause the Company to have, a Board consisting of one authorized director. The holders of a majority of the voting power of the issued and outstanding Ordinary Shares shall have right to designate, appoint, remove, replace and reappoint one director on the Board (the “Ordinary Directors”).

**12.2 Voting Agreements**

(i) With respect to each election of directors of the Board, each holder of voting securities of the Company shall vote at each meeting of shareholders of the Company, or in lieu of any such meeting shall give such holder’s written consent with respect to, as the case may be, all of such holder’s voting securities of the Company as may be necessary (i) to keep the authorized size of the Board at one director, (ii) to cause the election or re-election as members of the Board, and during such period to continue in office, each of the individuals designated pursuant to Section 12.1, and (iii) against any nominees not designated pursuant to Section 12.1.

(ii) Any Director designated pursuant to Section 12.1 may be removed from the Board, either for or without cause, upon written request of the Person or group of Persons then entitled to designate such Director pursuant to Section 12.1 or by the Company at any time when the Person or group of Persons no longer are entitled to designate such Director pursuant to Section 12.1, and the Parties agree not to seek, vote for or otherwise effect the removal of any such Director without such vote or written consent. Any Person or group of Persons then entitled to designate any individual to be elected as a Director on the Board shall have the exclusive right at any time or from time to time to remove any such Director occupying such position and to fill any vacancy caused by the death, disability, retirement, resignation or removal of any Director occupying such position or any other vacancy therein. Each holder of voting securities of the Company agrees to always vote such holder’s respective voting securities of the Company at a meeting of the members of the Company (and given written consents in lieu thereof) in support of the foregoing.

**12.3 Quorum.** The Board shall hold no less than one (1) board meeting during each fiscal quarter. A meeting of the Board shall only proceed where there are present (whether in person or by means of a conference telephone or any other equipment which allows all participants in the meeting to speak to and hear each other simultaneously) a majority of all Directors of such Group Company then in office. If within half an hour from the time appointed for the meeting a quorum is not present, the meeting shall stand adjourned to the same day in the next week at the same time and place or to such other time or such other place as the directors may determine.

**12.4 Expenses.** The Company will promptly pay or reimburse each non-employee Board member for all reasonable out-of-pocket expenses incurred in connection with attending board or committee meetings and otherwise performing their duties as directors and committee members.

**12.5 Alternates.** Subject to applicable Law, each Director shall be entitled to appoint an alternate to serve at any Board meeting, and such alternate shall be permitted to attend all Board meetings and vote on behalf of the director for whom she or he is serving as an alternate.

**13. Protective Provisions.**

**13.1 Acts of the Group Companies Requiring Approval of Majority Investors.** So long as no less than fifty percent (50%) of the Preferred Shares issued at the Closing are issued and outstanding, no Group Company shall take, permit to occur, approve, authorize, or agree or commit to do any of the following, and each Party shall procure the Company not to, and the shareholders of the Company shall procure the Company not to, take, permit to occur, approve, authorize, or agree or commit to do any of the following, whether in a single transaction or a series of related transactions, whether directly or indirectly, and whether or not by amendment, merger, consolidation, scheme of arrangement, amalgamation, or otherwise, without the written consent or affirmative vote of the Majority Investors, given in writing or by vote at a meeting, consenting or voting (as the case may be) (vote together and separately as a class or series),

(i) any adverse amendment or change of the rights, preferences, privileges or powers of, or the restrictions provided for the benefit of, the Preferred Shares;

(ii) creation, authorization or issuance of any class or series of Equity Securities having rights, preferences, privileges or powers superior to or on a parity with the Preferred Shares, whether as to liquidation, conversion, dividend, voting, redemption, or otherwise, or any Equity Securities convertible into, exchangeable for, or exercisable into any Equity Securities having rights, preferences, privileges or powers superior to or on a parity with any series of Preferred Shares, whether as to liquidation, conversion, dividend, voting, redemption or otherwise;

(iii) any action that reclassifies any issued and outstanding shares into shares having rights, preferences, privileges or powers senior to or on a parity with the Preferred Shares, whether as to liquidation, conversion, dividend, voting, redemption or otherwise;

(iv) any amendment or modification to the Charter, other than amendments pursuant to and in compliance with Section 15.17 hereof and other than to effect a Qualified IPO;

(v) any declaration, set aside or payment of a dividend or other distribution by the Company;

(vi) any change of the size or composition of the board of directors of any Group Company other than changes pursuant to and in compliance with this Agreement;

(vii) any increase or decrease in the authorized number of Preferred Shares, or any series thereof;



(viii) any Deemed Liquidation Event or any Share Sale or any merger, amalgamation, scheme or arrangement or consolidation of any Group Company with any Person, or the purchase or other acquisition by any Group Company of all or substantially all of the assets, equity or business of another Person, other than in any case an Approved Sale; or

(ix) any action by a Group Company to authorize, approve or enter into any agreement or obligation with respect to any action listed above.

#### 14. Additional Covenants.

**14.1 Business of the Group Companies.** The Company shall not engage in any business or operations without the approval of the Board. The business of each other Group Companies shall be restricted to the Business, except with the approval of the Board.

**14.2 No Avoidance; Voting Trust.** The Company will not, by any voluntary action, avoid or seek to avoid the observance or performance of any of the terms to be performed hereunder by the Company, and the Company will at all times in good faith assist and take action as appropriate in the carrying out of all of the provisions of this Agreement. Each holder of Shares agrees that it shall not enter into any other agreements or arrangements of any kind with respect to the voting of any Shares or deposit any Shares in a voting trust or other similar arrangement.

#### 14.3 Confidentiality.

(i) The terms and conditions of the Transaction Documents (collectively, the “**Confidential Information**”), including their existence, shall be considered confidential information and shall not be disclosed by any of the Parties to any other Person unless such Confidential Information (a) is known or becomes known to the public in general (other than as a result of a breach of this [Section 14.3\(i\)](#) by such Investor), (b) is or has been independently developed or conceived by the Investor without use of the Company’s Confidential Information, or (c) is or has been made known or disclosed to the Investor by a third party without a breach of any obligation of confidentiality such third party may have to the Company, and except that (i) each Party, as appropriate, may disclose any of the Confidential Information to its current or bona fide prospective investors, prospective permitted transferees, employees, investment bankers, lenders, accountants and attorneys, in each case only where such Persons are under appropriate nondisclosure obligations; (ii) each Investor may disclose any of the Confidential Information to its fund manager and the employees thereof so long as such Persons are under appropriate nondisclosure obligations; and (iii) if any Party is requested or becomes legally compelled (including without limitation, pursuant to the Applicable Securities Laws) to disclose the existence or content of any of the Confidential Information in contravention of the provisions of this Section, such Party shall promptly provide the other Parties with written notice of that fact so that such other Parties may seek a protective order, confidential treatment or other appropriate remedy and in any event shall furnish only that portion of the information that is legally required and shall exercise reasonable efforts to obtain reliable assurance that confidential treatment will be accorded such information.

(ii) The provisions of this Section shall terminate and supersede the provisions of any separate nondisclosure agreement executed by any of the Parties hereto with respect to the transactions contemplated hereby, including without limitation, any term sheet, letter of intent, memorandum of understanding or other similar agreement entered into by the Company and the Investors in respect of the transactions contemplated hereby.

**14.4 Controlled Foreign Corporation.** Each year, based on and in reliance of the information provided by the Investors, the Company shall make due inquiry with its tax advisors regarding whether the Company or any of its subsidiaries is treated as a “Controlled Foreign Corporation” (“CFC”) as defined in the Code, whether any portion of the Company’s or any of its subsidiaries’ income is “Subpart F Income” (as defined in Section 952 of the Code) (“Subpart F Income”) and each Investor’s share, if any, of such Subpart F Income (regardless of whether an Investor is a “United States Shareholder” or not). The Company shall furnish the results of such inquiry to the Investors no later than sixty (60) days following the end of the Company’s or applicable subsidiary’s taxable year. Each Investor shall reasonably cooperate with the Company to provide information necessary for the Company’s tax advisors to determine the status of such Investor, or such Investor’s Partners, as a “United States Shareholder” within the meaning of Section 951(b) of the Code, provided, however, that no Investor shall be required to provide any confidential information in connection with this determination. The Company shall make reasonable commercial efforts, and shall cause each of its subsidiaries to make reasonable commercial efforts, to provide each Investor in a timely manner with the information in its possession or reasonably obtainable that is necessary to allow such Investor or such Investor’s Partners to comply with its U.S. tax filing and reporting obligations as a result of any of the Company and its subsidiaries being treated as a CFC. For purposes of this Agreement, the term “Investor’s Partners” shall mean each of the Investor partners, members, shareholders and other equity holders and any direct or indirect owners of such partners, members, shareholders and other equity holders. The Company shall be deemed to satisfy its obligations set forth in this Section 12.5 in the event that it is unable to provide the information related to the CFC status of the Company or any of its subsidiaries solely as the result of the failure of an Investor to provide any relevant information.

**14.5 Passive Foreign Investment Company.** Each year, the Company shall make due inquiry with its tax advisors regarding the status of the Company and each of its subsidiaries as a “passive foreign investment company” within the meaning of Section 1297 of the Code (a “PFIC”). The Company shall notify the Investors of the results of such determination no later than sixty (60) days following the end of the Company’s or applicable subsidiary’s taxable year. Without limiting the Company’s obligations pursuant to Section 14.5, in connection with a “Qualified Electing Fund” election made by an Investor or any of an Investor’s Partners pursuant to Section 1295 of the Code with respect to the Company or any of its subsidiaries or a “Protective Statement” filed by an Investor or any of an Investor’s Partners pursuant to Treasury Regulation Section 1.1295-3, as amended (or any successor thereto), with respect to the Company or any of its subsidiaries, the Company shall, and shall cause each of its subsidiaries to, provide the information requested by the Investor necessary for the Investor and the Investor’s Partners to comply with the U.S. tax filing and reporting obligations with respect to such Qualified Electing Fund election or Protective Statement, including without limitation a PFIC Annual Information Statement under Section 1295(b) of the Code, and a completed IRS Form 8621, no later than seventy-five (75) days following the end of each taxable year commencing with the first taxable year for which the Company is a PFIC.

**14.6 Provision of U.S. Tax Reporting Information.** The Company shall make commercially reasonable efforts, and shall cause its subsidiaries to make commercially reasonable efforts, to provide as promptly as possible, an Investor with the information in the Company's or any of its subsidiaries' possession or reasonably obtainable by the Company or any of its subsidiaries as is reasonably requested by the Investor to allow such Investor or any of an Investor's Partners to comply with their U.S. tax filing and reporting obligations for the prior calendar year including completed IRS Forms 5471 and 926 for such Investor.

**14.7 Costs.** Any and all costs incurred by any Group Company in providing the information that it is required to provide, or is required to cause to be provided, and the cost incurred by the Group Company in taking the action, or causing the action to be taken, described in Sections 14.4, 14.5 and 14.6 shall be borne by the relevant Investors.

**14.8 U.S. Tax Classification.** The Company is intended to be classified and treated as an association taxable as a corporation for U.S. tax purposes. If necessary to ensure such classification, the Investors shall cooperate to cause the Company to timely execute and file United States Internal Revenue Form 8832 electing to treat the Company as a corporation for U.S. Federal income tax purposes pursuant to Section 301.7701-3 of the U.S. Treasury Regulations. In connection therewith, each of the Investors hereby consent to such election and agrees to cooperate to effect such election. The Company shall furnish a copy of such Form 8832 as requested by an Investor promptly after the filing thereof. The Company shall not elect to be treated as anything other than an association taxable as a corporation for U.S. federal, state or local income tax purposes under U.S. Treasury Regulations section 301.7701-3(a) or under any corresponding provision of state or local law, without the prior written consent of all the Investors.

**15. Miscellaneous.**

**15.1 Termination.** This Agreement shall terminate upon mutual consent of the Parties hereto. The provisions of Sections 7, 8, 12, 13, and 14 shall terminate on the earliest of the consummation of the Qualified IPO or a Deemed Liquidation Event. If this Agreement terminates, the Parties shall be released from their obligations under this Agreement, except in respect of any obligation stated, explicitly or otherwise, to continue to exist after the termination of this Agreement (including without limitation those under Sections 2 through 6, 14.3 and Section 15). This Agreement shall terminate with respect to any shareholder of the Company when such shareholder no longer holds any Shares. If any Party breaches this Agreement before the termination of this Agreement, it shall not be released from its obligations arising from such breach on termination.

**15.2 Further Assurances.** Upon the terms and subject to the conditions herein, each of the Parties hereto agrees to use its commercially reasonable efforts to take or cause to be taken all action, to do or cause to be done, to execute such further instruments, and to assist and cooperate with the other Parties hereto in doing, all things necessary, proper or advisable under applicable Laws or otherwise to consummate and make effective, in the most expeditious manner practicable, the transactions contemplated by this Agreement.

**15.3 Assignments and Transfers; No Third Party Beneficiaries.** Except as otherwise provided herein, this Agreement and the rights and obligations of the Parties hereunder shall inure to the benefit of, and be binding upon, their respective successors, assigns and legal representatives, but shall not otherwise be for the benefit of any third party. The rights of any Investor hereunder (including, without limitation, registration rights) are assignable (together with the related obligations) to an Affiliate, or a third party in connection with the transfer of Equity Securities of the Company held by such Investor but only to the extent of such transfer, and any such transferee shall execute and deliver to the Company a deed of adherence or joinder becoming a party hereto as an "Investor" subject to the terms and conditions hereof (if not already so bound). This Agreement and the rights and obligations of each other Party hereunder shall not otherwise be assigned without the mutual written consent of the other Parties except as expressly provided herein.

**15.4 Governing Law.** This Agreement and all actions arising out of or in connection with this Agreement shall be governed by and construed under the Laws of the State of Hong Kong, without regard to principles of conflict of laws thereunder.

**15.5 Dispute Resolution.**

(i) Any dispute, controversy, difference or claim (each, a “Dispute”) arising out of or relating to this Agreement, or the interpretation, breach, termination, validity or invalidity thereof, shall be referred to arbitration upon the demand of either party to the dispute with notice (the “Arbitration Notice”) to the other.

(ii) The Dispute shall be settled by arbitration in Hong Kong administered by the Hong Kong International Arbitration Centre (the “HKIAC”) in accordance with the Hong Kong International Arbitration Centre Administered Arbitration Rules (the “HKIAC Rules”) in force when the Arbitration Notice is submitted in accordance with the HKIAC Rules. There shall be one (1) arbitrator. The HKIAC council shall select the arbitrator, who shall be qualified to practice law in Hong Kong.

(iii) The arbitral proceedings shall be conducted in English. To the extent that the HKIAC Rules are in conflict with the provisions of this Section, including the provisions concerning the appointment of the arbitrators, the provisions of this Section shall prevail.

(iv) The costs of arbitration shall be borne by the losing party, unless otherwise determined by the arbitral tribunal.

(v) The award of the arbitral tribunal shall be final and binding upon the parties thereto, and the prevailing party may apply to a court of competent jurisdiction for enforcement of such award.

(vi) The arbitral tribunal shall decide any Dispute submitted by the parties to the arbitration strictly in accordance with the substantive Law of Hong Kong (without regard to principles of conflict of Laws thereunder) and shall not apply any other substantive Law.

(vii) Any party to the Dispute shall be entitled to seek preliminary injunctive relief, if possible, from any court of competent jurisdiction in accordance with the applicable Laws of that jurisdiction.

(viii) When any Dispute occurs and when any Dispute is under arbitration, except for the matters in Dispute, the Parties shall continue to fulfill their respective obligations and shall be entitled to exercise their rights under this Agreement.

**15.6 Notices.** Any notice required or permitted pursuant to this Agreement shall be given in writing and shall be given either personally or by sending it by next-day or second-day courier service, fax, electronic mail or similar means to the address of the relevant Party as shown on Schedule B (or at such other address as such Party may designate by fifteen (15) days' advance written notice to the other Parties to this Agreement given in accordance with this Section). Where a notice is sent by next-day or second-day courier service, service of the notice shall be deemed to be effected by properly addressing, pre-paying and sending by next-day or second-day service through an internationally-recognized courier a letter containing the notice, with a written confirmation of delivery, and to have been effected at the earlier of (i) delivery (or when delivery is refused) and (ii) expiration of two (2) Business Days after the letter containing the same is sent as aforesaid. Where a notice is sent by fax or electronic mail, service of the notice shall be deemed to be effected by properly addressing, and sending such notice through a transmitting organization, with a written confirmation of delivery, and to have been effected on the day the same is sent as aforesaid, if such day is a Business Day and if sent during normal business hours of the recipient, otherwise the next Business Day. Notwithstanding the foregoing, to the extent a "with a copy to" address is designated, notice must also be given to such address in the manner above for such notice, request, consent or other communication hereunder to be effective.

**15.7 Expenses.** If any action at law or in equity is necessary to enforce or interpret the terms of this Agreement, the prevailing Party shall be entitled to reasonable attorneys' fees, costs and necessary disbursements in addition to any other relief to which such Party may be entitled.

**15.8 Rights Cumulative; Specific Performance.** Each and all of the various rights, powers and remedies of a Party hereto will be considered to be cumulative with and in addition to any other rights, powers and remedies which such Party may have at Law or in equity in the event of the breach of any of the terms of this Agreement. The exercise or partial exercise of any right, power or remedy will neither constitute the exclusive election thereof nor the waiver of any other right, power or remedy available to such Party. Without limiting the foregoing, the Parties hereto acknowledge and agree irreparable harm may occur for which money damages would not be an adequate remedy in the event that any of the provisions of this Agreement were not performed in accordance with their specific terms or were otherwise breached. It is accordingly agreed that the Parties shall be entitled to injunction to prevent breaches of this Agreement and to enforce specifically the terms and provisions of this Agreement.

**15.9 Successor Indemnification.** If the Company or any of its successors or assignees consolidates with or merges into any other Person and is not the continuing or surviving corporation or entity of such consolidation or merger, then to the extent necessary, proper provision shall be made so that the successors and assignees of the Company assume the obligations of the Company with respect to indemnification of members of the Board of Directors as in effect immediately before such transaction, whether such obligations are contained in the Memorandum and Articles, or elsewhere, as the case may be.

**15.10 Severability.** In case any provision of the Agreement shall be invalid, illegal or unenforceable, the validity, legality and enforceability of the remaining provisions shall not in any way be affected or impaired thereby. If, however, any provision of this Agreement shall be invalid, illegal, or unenforceable under any such applicable Law in any jurisdiction, it shall, as to such jurisdiction, be deemed modified to conform to the minimum requirements of such Law, or, if for any reason it is not deemed so modified, it shall be invalid, illegal, or unenforceable only to the extent of such invalidity, illegality, or limitation on enforceability without affecting the remaining provisions of this Agreement, or the validity, legality, or enforceability of such provision in any other jurisdiction.

**15.11 Amendments and Waivers.** Any provision in this Agreement may be amended and the observance thereof may be waived (either generally or in a particular instance and either retroactively or prospectively), only by the written consent of (i) the Company; (ii) the Majority Investors; provided, however, that (1) no amendment or waiver shall be effective or enforceable in respect of a holder of any class or series of Shares if such amendment or waiver affects such holder materially and adversely differently from the other or holders of the same series of Preferred Shares, respectively, unless such holder consents in writing to such amendment or waiver, and (2) any provision that specifically and expressly gives a right to a named Investor shall not be amended or waived without the prior written consent of such named Investor. Notwithstanding the foregoing, any Party hereunder may waive any of its/his rights hereunder without obtaining the consent of any parties. Any amendment or waiver effected in accordance with this Section shall be binding upon all the Parties hereto.

**15.12 No Waiver.** Failure to insist upon strict compliance with any of the terms, covenants, or conditions hereof will not be deemed a waiver of such term, covenant, or condition, nor will any waiver or relinquishment of, or failure to insist upon strict compliance with, any right, power or remedy hereunder at any one or more times be deemed a waiver or relinquishment of such right, power or remedy at any other time or times.

**15.13 Delays or Omissions.** No delay or omission to exercise any right, power or remedy accruing to any Party under this Agreement, upon any breach or default of any other Party under this Agreement, shall impair any such right, power or remedy of such non-breaching or non-defaulting Party nor shall it be construed to be a waiver of any such breach or default, or an acquiescence therein, or of or in any similar breach or default thereafter occurring; nor shall any waiver of any single breach or default be deemed a waiver of any other breach or default theretofore or thereafter occurring. Any waiver, permit, consent or approval of any kind or character on the part of any Party of any breach or default under this Agreement, or any waiver on the part of any Party of any provisions or conditions of this Agreement, must be in writing and shall be effective only to the extent specifically set forth in such writing.

**15.14 No Presumption.** The Parties acknowledge that any applicable Law that would require interpretation of any claimed ambiguities in this Agreement against the Party that drafted it has no application and is expressly waived. If any claim is made by a Party relating to any conflict, omission or ambiguity in the provisions of this Agreement, no presumption or burden of proof or persuasion will be implied because this Agreement was prepared by or at the request of any Party or its counsel.

**15.15 Counterparts.** This Agreement may be executed in two or more counterparts, each of which shall be deemed an original, but all of which together shall constitute one and the same instrument. Facsimile and e-mailed copies of signatures shall be deemed to be originals for purposes of the effectiveness of this Agreement.

**15.16 Entire Agreement.** This Agreement (including the Exhibits hereto) constitutes the full and entire understanding and agreement among the Parties with regard to the subjects hereof, and supersedes all other agreements between or among any of the Parties with respect to the subject matter hereof.

**15.17 Control.** In the event of any conflict or inconsistency between any of the terms of this Agreement and any of the terms of any of the Charter Documents for any of the Group Companies, or in the event of any dispute related to any such Charter Document, the terms of this Agreement shall prevail in all respects, the Parties shall give full effect to and act in accordance with the provisions of this Agreement over the provisions of the Charter Documents, and the Parties hereto shall exercise all voting and other rights and powers (including to procure any required alteration to such Charter Documents to resolve such conflict or inconsistency) to make the provisions of this Agreement effective, and not to take any actions that impair any provisions in this Agreement.

**15.18 Aggregation of Shares.** All Shares held or acquired by any Affiliates shall be aggregated together for the purpose of determining the availability of any rights of any Investor under this Agreement.

**15.19 Use of English Language.** This Agreement has been executed and delivered in the English language. Any translation of this Agreement into another language shall have no interpretive effect. All documents or notices to be delivered pursuant to or in connection with this Agreement shall be in the English language or, if any such document or notice is not in the English language, accompanied by an English translation thereof, and the English language version of any such document or notice shall control for purposes thereof.

**15.20 Effective Date.** This Agreement shall only take effect and become binding on and enforceable against the Parties subject to and upon the Closing as defined in the Purchase Agreement.

*[The remainder of this page has been intentionally left blank.]*

IN WITNESS WHEREOF, the parties hereto have caused their respective duly authorized representatives to execute this Agreement on the date and year first above written.

Company:

Belite Bio, Inc

By: /s/ Tom Lin

Name: Tom Lin

Title: Director

[Signature Page to Shareholders Agreement]

---



IN WITNESS WHEREOF, the parties hereto have caused their respective duly authorized representatives to execute this Agreement on the date and year first above written.

PRINCIPAL:

Lin Bioscience International Ltd.

By: /s/ Tom Lin  
Name: Tom Lin  
Title: Director

[Signature Page to Shareholders Agreement]

---

IN WITNESS WHEREOF, the parties hereto have caused their respective duly authorized representatives to execute this Agreement as on the date and year first above written.

INVESTOR:

By: /s/ Cheng-Chao Sung  
Name: Cheng-Chao Sung  
ID: #####

[Signature Page to Shareholders Agreement]

---

IN WITNESS WHEREOF, the parties hereto have caused their respective duly authorized representatives to execute this Agreement as on the date and year first above written.

INVESTOR:

By: /s/ Sen-Tai Chen  
Name: Sen-Tai Chen  
ID: #####

---

[Signature Page to Shareholders Agreement]

---

IN WITNESS WHEREOF, the parties hereto have caused their respective duly authorized representatives to execute this Agreement as on the date and year first above written.

INVESTOR:

By: /s/ Yun-Ju Huang  
Name: Yun-Ju Huang  
ID: #####

---

[Signature Page to Shareholders Agreement]

---

IN WITNESS WHEREOF, the parties hereto have caused their respective duly authorized representatives to execute this Agreement as on the date and year first above written.

INVESTOR:

By: /s/ Cheng-Han Huang  
Name: Cheng-Han Huang  
ID: #####

[Signature Page to Shareholders Agreement]

---

IN WITNESS WHEREOF, the parties hereto have caused their respective duly authorized representatives to execute this Agreement as on the date and year first above written.

INVESTOR:

H&D Asset Management Co., Ltd.  
(Company Seal)

By: /s/ Ping-Yu Chu (Seal)  
Name: Ping-Yu Chu  
Title: Legal Representative  
ID: #####

---

[Signature Page to Shareholders Agreement]

---

IN WITNESS WHEREOF, the parties hereto have caused their respective duly authorized representatives to execute this Agreement as on the date and year first above written.

INVESTOR:

By: /s/ Tian-Ren Huang  
Name: Tian-Ren Huang  
ID: #####

---

[Signature Page to Shareholders Agreement]

---

IN WITNESS WHEREOF, the parties hereto have caused their respective duly authorized representatives to execute this Agreement as on the date and year first above written.

INVESTOR:

Grand Fortune Venture Capital Corporation  
(Company Seal)

By: /s/ Hsien-Hua Huang  
Name: Hsien-Hua Huang  
Title: Chairman  
ID: #####

---

[Signature Page to Shareholders Agreement]

---



IN WITNESS WHEREOF, the parties hereto have caused their respective duly authorized representatives to execute this Agreement as on the date and year first above written.

INVESTOR:

Foryou Venture Capital Limited Partnership  
(Company Seal)

By: /s/ Hsien-Hua Huang  
Name: Hsien-Hua Huang  
Title: Legal Representative  
ID: #####

---

[Signature Page to Shareholders Agreement]

---

IN WITNESS WHEREOF, the parties hereto have caused their respective duly authorized representatives to execute this Agreement as on the date and year first above written.

INVESTOR:

YUN HSIEN ENTERPRISE CO., LTD  
(Company Seal)

By: (Seal) Yu-Hsien Wu  
Name: Yu-Hsien Wu  
Title: Chairman  
ID: #####

---

[Signature Page to Shareholders Agreement]

---

IN WITNESS WHEREOF, the parties hereto have caused their respective duly authorized representatives to execute this Agreement as on the date and year first above written.

INVESTOR:

By: /s/ Hsueh-Jung Hsia  
Name: Hsueh-Jung Hsia  
ID: #####

---

[Signature Page to Shareholders Agreement]

---

IN WITNESS WHEREOF, the parties hereto have caused their respective duly authorized representatives to execute this Agreement as on the date and year first above written.

INVESTOR:

By: /s/ Hao-Wei Chu  
Name: Hao-Wei Chu  
ID: #####

---

[Signature Page to Shareholders Agreement]

---

IN WITNESS WHEREOF, the parties hereto have caused their respective duly authorized representatives to execute this Agreement as on the date and year first above written.

INVESTOR:

Foryou Capital Corporation  
(Company Seal)

By: /s/ Hsien-Hua Huang  
Name: Hsien-Hua Huang  
Title: Chairman  
ID: #####

---

[Signature Page to Shareholders Agreement]

---

IN WITNESS WHEREOF, the parties hereto have caused their respective duly authorized representatives to execute this Agreement as on the date and year first above written.

INVESTOR:

By: /s/ Ching-Yu Peng  
Name: Ching-Yu Peng  
ID: #####

[Signature Page to Shareholders Agreement]

---

IN WITNESS WHEREOF, the parties hereto have caused their respective duly authorized representatives to execute this Agreement as on the date and year first above written.

INVESTOR:

Lin Bioscience International Ltd.

By: /s/ Tom Lin  
Name: Tom Lin  
Title: Director  
ID: #####

---

[Signature Page to Shareholders Agreement]

---

**SCHEDULE A-1**  
**LIST OF PRINCIPALS**

Shareholders Agreement

---



SCHEDULE A-2

LIST OF SERIES A INVESTORS

Shareholders Agreement

---

**SCHEDULE A-3**

**LIST OF SERIES B INVESTORS**

Shareholders Agreement

---

**SCHEDULE B**

**ADDRESS FOR NOTICES**

Shareholders Agreement

---

**AMENDMENT TO AMENDED AND RESTATED SHAREHOLDERS AGREEMENT**

THIS AMENDMENT TO AMENDED AND RESTATED SHAREHOLDERS AGREEMENT (this "**AMENDMENT**") is entered into on November 1, 2021 by and among

1. Belite Bio, Inc, an exempted company incorporated under the laws of the Cayman Islands with limited liability (the "**Company**"),
2. each of the Persons named on Schedule A-1 attached hereto (collectively, the "**Principals**", and each an "**Principal**");
3. each of the Persons listed in Schedule A-2 attached hereto (collectively, the "**Investors**", and each an "**Investor**").

Each of the parties to this Amendment is referred to herein individually as a "**Party**" and collectively as the "**Parties**".

**RECITALS**

- A The Parties and certain other parties thereto entered into that certain Amended and Restated Shareholders Agreement on December 23, 2020 (the "**Shareholders Agreement**").
- B The Parties hereto constitute the required parties set forth in Section 15.11 of the Shareholders Agreement and desire to amend the Shareholders Agreement as set forth in this Amendment.

**WITNESSETH**

NOW, THEREFORE, in consideration of the foregoing recitals, the mutual promises hereinafter set forth, and other good and valuable consideration, the receipt and sufficiency of which are hereby acknowledged, the Parties intending to be legally bound hereto hereby agree as follows:

1. **Definitions.** Capitalized terms used and not otherwise defined herein shall have the meaning ascribed to them in the Shareholders Agreement.

2. **Amendments.**

- 2.1 Section 12.1(i) of the Shareholders Agreement shall be deleted and replaced in its entirety by the following to read:

**12.1 Board of Directors.**

(i) The Company shall have, and the Parties hereto agree to cause the Company to have, a Board consisting of four (4) authorized directors. The holders of a majority of the voting power of the issued and outstanding Ordinary Shares shall have right to designate, appoint, remove, replace and reappoint four (4) directors on the Board (the "**Ordinary Directors**").

- 2.2 Section 12.2(i) of the Shareholders Agreement shall be deleted and replaced in its entirety by the following to read:

Belite Bio, Inc Amendment to Amended and  
Restated Shareholders Agreement

---

## 12.2 Voting Agreements

(i) With respect to each election of directors of the Board, each holder of voting securities of the Company shall vote at each meeting of shareholders of the Company, or in lieu of any such meeting shall give such holder's written consent with respect to, as the case may be, all of such holder's voting securities of the Company as may be necessary (i) to keep the authorized size of the Board at four (4) directors, (ii) to cause the election or re-election as members of the Board, and during such period to continue in office, each of the individuals designated pursuant to Section 12.1, and (iii) against any nominees not designated pursuant to Section 12.1.

2.3 Section 15.1 of the Shareholders Agreement shall be deleted and replaced in its entirety by the following to read:

**15.1 Termination.** This Agreement shall terminate upon mutual consent of the Parties hereto. The provisions of Sections 7, 8, 9, 10, 11, 12, 13, and 14 shall terminate on the earliest of the consummation of the Qualified IPO or a Deemed Liquidation Event. If this Agreement terminates, the Parties shall be released from their obligations under this Agreement, except in respect of any obligation stated, explicitly or otherwise, to continue to exist after the termination of this Agreement (including without limitation those under Sections 2 through 6, 14.3 and Section 15). This Agreement shall terminate with respect to any shareholder of the Company when such shareholder no longer holds any Shares. If any Party breaches this Agreement before the termination of this Agreement, it shall not be released from its obligations arising from such breach on termination.

## 3. Miscellaneous.

**3.1 General; Effective Date.** Except as amended hereby, the Shareholders Agreement has not been modified, and as amended hereby, is in full force and effect. The Shareholders Agreement, as amended by this Amendment, represents the final, entire and complete agreement among the Parties with respect to the subject matter of the Shareholders Agreement and this Amendment and supersedes all other prior or contemporaneous agreements, communications or representations, whether oral or written, express or implied. This Amendment constitutes a part of the Shareholders Agreement and all references in the Shareholders Agreement to the Shareholders Agreement (e.g., "this Agreement," "herein," etc.) shall constitute references to the Shareholders Agreement as amended by this Amendment.

**3.2 Governing Law.** This Amendment and all actions arising out of or in connection with this Amendment shall be governed by and construed in accordance with the Laws of Hong Kong, without regard to the conflicts of law provisions of any jurisdiction.

**3.3 Counterparts.** This Amendment may be executed in two or more counterparts, each of which shall be deemed an original, but all of which together shall constitute one and the same instrument. Counterparts may be delivered via facsimile, electronic mail (including pdf or any electronic signature complying with the U.S. federal E-SIGN Act of 2000, e.g., www.docusign.com) or other transmission method and any counterpart so delivered shall be deemed to have been duly and validly delivered and be valid and effective for all purposes.

Belite Bio, Inc Amendment to Amended and  
Restated Shareholders Agreement

---

*[The remainder of this page has been intentionally left blank.]*

IN WITNESS WHEREOF, the parties hereto have caused their respective duly authorized representatives to execute this Amendment on the date and year first above written.

COMPANY:

**Belite Bio, Inc**

By: /s/ Tom Lin

Name: Tom Lin (Yu-Hsin Lin)

Title: Director

[Signature Page to Belite Bio, Inc Amendment to Amended and Restated Shareholders Agreement]

---

IN WITNESS WHEREOF, the parties hereto have caused their respective duly authorized representatives to execute this Amendment on the date and year first above written.

Principal & Investor:

**Lin Bioscience International Ltd.**

By: /s/ Tom Lin  
Name: Tom Lin (Yu-Hsin Lin)  
Title: Director

[Signature Page to Belite Bio, Inc Amendment to Amended and Restated Shareholders Agreement]

---



IN WITNESS WHEREOF, the parties hereto have caused their respective duly authorized representatives to execute this Amendment on the date and year first above written.

Investor:

**Cheng-Chao Sung (ID: #####)**

/s/ Cheng-Chao Sung

---

[Signature Page to Belite Bio, Inc Amendment to Amended and Restated Shareholders Agreement]

---

IN WITNESS WHEREOF, the parties hereto have caused their respective duly authorized representatives to execute this Amendment on the date and year first above written.

Investor:

**Yun-Ju Huang (ID: ##### )**

/s/ Yun-Ju Huang

---

[Signature Page to Belite Bio, Inc Amendment to Amended and Restated Shareholders Agreement]

---

IN WITNESS WHEREOF, the parties hereto have caused their respective duly authorized representatives to execute this Amendment on the date and year first above written.

Investor:

**Cheng-Han Huang (ID: #####)**

/s/ Cheng-Han Huang

---

[Signature Page to Belite Bio, Inc Amendment to Amended and Restated Shareholders Agreement]

---

IN WITNESS WHEREOF, the parties hereto have caused their respective duly authorized representatives to execute this Amendment on the date and year first above written.

Investor:

**H&D (SINGAPORE) INVESTMENT HOLDING PTE. LTD. (ID: ##### )**

By: /s/ Chu Ping Yu

Name: Chu Ping Yu

Title: Director

[Signature Page to Belite Bio, Inc Amendment to Amended and Restated Shareholders Agreement]

---

IN WITNESS WHEREOF, the parties hereto have caused their respective duly authorized representatives to execute this Amendment on the date and year first above written.

Investor:

**Grand Fortune Venture Capital Corporation (ID: #####)**

**(Company Seal)**

By: /s/ Huang Hsien Hua

Name:

Title:

[Signature Page to Belite Bio, Inc Amendment to Amended and Restated Shareholders Agreement]

---

IN WITNESS WHEREOF, the parties hereto have caused their respective duly authorized representatives to execute this Amendment on the date and year first above written.

Investor:

**Foryou Venture Capital Limited Partnership (ID: #####)**

**(Company Seal)**

By: /s/ Huang Hsien Hua

Name:

Title:

[Signature Page to Belite Bio, Inc Amendment to Amended and Restated Shareholders Agreement]

---

IN WITNESS WHEREOF, the parties hereto have caused their respective duly authorized representatives to execute this Amendment on the date and year first above written.

Investor:

**YUN HSIEN ENTERPRISE CO., LTD (ID: #####)**

**(Company Seal)**

By: (seal) Yu-Hsien Wu

Name: Yu-Hsien Wu

Title:

[Signature Page to Belite Bio, Inc Amendment to Amended and Restated Shareholders Agreement]

---

IN WITNESS WHEREOF, the parties hereto have caused their respective duly

IN WITNESS WHEREOF, the parties hereto have caused their respective duly authorized representatives to execute this Amendment on the date and year first above written.

Investor:

**Foryou Capital Corporation (ID: #####)**

**(Company Seal)**

By: /s/ Huang Hsien Hua

Name:

Title:

[Signature Page to Belite Bio, Inc Amendment to Amended and Restated Shareholders Agreement]

---



IN WITNESS WHEREOF, the parties hereto have caused their respective duly authorized representatives to execute this Amendment on the date and year first above written.

Investor:

**Ching-Yu Peng (ID: #####)**

/s/ Ching-Yu Peng

---

[Signature Page to Belite Bio, Inc Amendment to Amended and Restated Shareholders Agreement]

---

**SCHEDULE A-1**

**List of PRINCIPALS**

Belite Bio, Inc Amendment to Amended and  
Restated Shareholders Agreement

---

**SCHEDULE A-2**  
**LIST OF INVESTORS**

Belite Bio, Inc Amendment to Amended and  
Restated Shareholders Agreement

---

Belite Bio, Inc  
5820 Oberlin Drive  
Suite 101, San Diego  
CA 92121

5 April 2022

Dear Sir or Madam

**Belite Bio, Inc**

We have acted as Cayman Islands legal advisers to Belite Bio, Inc (the "**Company**") in connection with the Company's registration statement on Form F-1, including all amendments or supplements thereto (the "**Registration Statement**"), filed with the Securities and Exchange Commission under the U.S. Securities Act of 1933, as amended to date relating to the offering by the Company of certain American depository shares (the "**ADSs**") representing the Company's ordinary shares of a par value of US\$0.0001 each (the "**Shares**").

We are furnishing this opinion as Exhibits 5.1, 8.1 and 23.2 to the Registration Statement.

**1 Documents Reviewed**

For the purposes of this opinion, we have reviewed only originals, copies or final drafts of the following documents:

- 1.1 The certificate of incorporation of the Company dated 27 March 2018 and the certificate of incorporation on change of name of the Company dated 8 October 2018 issued by the Registrar of Companies in the Cayman Islands.
  - 1.2 The second amended and restated memorandum and articles of association of the Company as adopted by a special resolution passed on 23 December 2020, and effective on 24 December 2020 (as amended by a special resolution passed on 1 November 2021) (the "**Pre-IPO Memorandum and Articles**").
  - 1.3 The third amended and restated memorandum and articles of association of the Company as conditionally adopted by a special resolution passed on 5 April 2022 and effective immediately prior to the completion of the initial public offering of the Company's ADSs representing its Shares (the "**IPO Memorandum and Articles**").
  - 1.4 The written resolutions of the directors of the Company dated 25 November 2021 and 5 April 2022 (the "**Directors' Resolutions**").
  - 1.5 The minutes of the extraordinary general meeting of the shareholders of the Company held on 5 April 2022 (the "**EGM Minutes**").
-

- 1.6 A certificate from a director of the Company, a copy of which is attached hereto (the "**Director's Certificate**").
- 1.7 A certificate of good standing dated 14 March 2022, issued by the Registrar of Companies in the Cayman Islands (the "**Certificate of Good Standing**").
- 1.8 The Registration Statement.

## **2 Assumptions**

The following opinions are given only as to, and based on, circumstances and matters of fact existing and known to us on the date of this opinion letter. These opinions only relate to the laws of the Cayman Islands which are in force on the date of this opinion letter. In giving these opinions we have relied (without further verification) upon the completeness and accuracy, as of the date of this opinion letter, of the Director's Certificate and the Certificate of Good Standing. We have also relied upon the following assumptions, which we have not independently verified:

- 2.1 Copies of documents, conformed copies or drafts of documents provided to us are true and complete copies of, or in the final forms of, the originals.
- 2.2 All signatures, initials and seals are genuine.
- 2.3 There is nothing under any law (other than the law of the Cayman Islands), which would or might affect the opinions set out below.

## **3 Opinion**

Based upon the foregoing and subject to the qualifications set out below and having regard to such legal considerations as we deem relevant, we are of the opinion that:

- 3.1 The Company has been duly incorporated as an exempted company with limited liability and is validly existing and in good standing with the Registrar of Companies in the Cayman Islands under the laws of the Cayman Islands.
- 3.2 The authorised share capital of the Company, with effect immediately prior to the completion of the Company's initial public offering of the ADSs representing the Shares, will be US\$50,000 divided into 500,000,000 shares comprising of (i) 400,000,000 ordinary shares of a par value of US\$0.0001 each, and (ii) 100,000,000 shares of a par value of US\$0.0001 each of such class or classes (however designated) as the board of directors may determine in accordance with the IPO Memorandum and Articles.
- 3.3 The issue and allotment of the Shares have been duly authorised and when allotted, issued and paid for as contemplated in the Registration Statement, the Shares will be legally issued and allotted, fully paid and non-assessable. As a matter of Cayman Islands law, a share is only issued when it has been entered in the register of members (shareholders).
- 3.4 The statements under the caption "Taxation" in the prospectus forming part of the Registration Statement, to the extent that they constitute statements of Cayman Islands law, are accurate in all material respects and that such statements constitute our opinion.

#### 4 Qualifications

In this opinion the phrase "non-assessable" means, with respect to the Shares in the Company, that a shareholder shall not, solely by virtue of its status as a shareholder, be liable for additional assessments or calls on the Shares by the Company or its creditors (except in exceptional circumstances, such as involving fraud, the establishment of an agency relationship or an illegal or improper purpose or other circumstances in which a court may be prepared to pierce or lift the corporate veil).

Except as specifically stated herein, we make no comment with respect to any representations and warranties which may be made by or with respect to the Company in any of the documents or instruments cited in this opinion or otherwise with respect to the commercial terms of the transactions, which are the subject of this opinion.

We hereby consent to the filing of this opinion as an exhibit to the Registration Statement and to the reference to our name under the headings "Enforceability of Civil Liabilities", "Taxation" and "Legal Matters" and elsewhere in the prospectus included in the Registration Statement. In giving such consent, we do not thereby admit that we come within the category of persons whose consent is required under Section 7 of the U.S. Securities Act of 1933, as amended, or the Rules and Regulations of the Commission thereunder.

Yours faithfully

/s/ Maples and Calder (Hong Kong) LLP

Maples and Calder (Hong Kong) LLP

Director's Certificate

April 5, 2022

To: Maples and Calder (Hong Kong) LLP  
26th Floor, Central Plaza  
18 Harbour Road  
Wanchai, Hong Kong

Dear Sirs

**Belite Bio, Inc (the "Company")**

I, the undersigned, being a director of the Company, am aware that you are being asked to provide a legal opinion (the "**Opinion**") in relation to certain aspects of Cayman Islands law. Unless otherwise defined herein, capitalised terms used in this certificate have the meaning given to them in the Opinion. I hereby certify that:

- 1 The Pre-IPO Memorandum and Articles remain in full force and effect and, except as amended by the resolutions as set out in the EGM Minutes adopting the IPO Memorandum and Articles, are otherwise unamended.
- 2 The Directors' Resolutions were duly passed in the manner prescribed in the Pre-IPO Memorandum and Articles (including, without limitation, with respect to the disclosure of interests (if any) by each director of the Company) and have not been amended, varied or revoked in any respect.
- 3 The EGM Minutes are a true and correct record of the proceedings of the EGM, which was duly convened and held, and at which a quorum was present throughout, in each case, in the manner prescribed in the Pre-IPO Memorandum and Articles. The resolutions set out in the EGM Minutes were duly passed in the manner prescribed in the Pre-IPO Memorandum and Articles and have not been amended, varied or revoked in any respect.
- 4 The authorised share capital of the Company is US\$50,000 divided into (i) 492,179,086 ordinary shares of par value US\$0.0001 each, (ii) 2,377,642 series A preferred shares of par value US\$0.0001 each, and (iii) 5,443,272 series B preferred shares of par value US\$0.0001 each.
- 5 The authorised share capital of the Company, with effect immediately prior to the completion of the Company's initial public offering of the ADSs representing the Shares, will be US\$50,000 divided into 500,000,000 shares comprising of (i) 400,000,000 ordinary shares of a par value of US\$0.0001 each, and (ii) 100,000,000 shares of a par value of US\$0.0001 each of such class or classes (however designated) as the board of directors may determine in accordance with the IPO Memorandum and Articles.
- 6 The minute book and corporate records of the Company as maintained at its registered office in the Cayman Islands and made available to you are complete and accurate in all material respects, and all minutes and resolutions filed therein represent a complete and accurate record of all meetings of the shareholders and directors (or any committee thereof) of the Company (duly convened in accordance with the Pre-IPO Memorandum and Articles) and all resolutions passed at the meetings or passed by written resolution or consent, as the case may be.

- 7 The shareholders of the Company have not restricted or limited the powers of the directors in any way and there is no contractual or other prohibition (other than as arising under Cayman Islands law) binding on the Company prohibiting it from issuing and allotting the Shares or otherwise performing its obligations under the Registration Statement.
- 8 The directors of the Company at the date of the Director's Resolutions and at the date hereof were and are:
- Yu-Hsin Lin  
Hao-Yuan Chuang  
Hung-Wei Chen  
Wan-Shan Chen
- 9 Each director of the Company considers the transactions contemplated by the Registration Statement to be of commercial benefit to the Company and has acted bona fide in the best interests of the Company, and for a proper purpose of the Company in relation to the transactions the subject of the Opinion.
- 10 To the best of my knowledge and belief, having made due inquiry, the Company is not the subject of legal, arbitral, administrative or other proceedings in any jurisdiction that would have a material adverse effect on the business, properties, financial condition, results of operations or prospects of the Company. Nor have the directors or shareholders taken any steps to have the Company struck off or placed in liquidation, nor have any steps been taken to wind up the Company. Nor has any receiver been appointed over any of the Company's property or assets.
- 11 Upon the completion of the Company's initial public offering of the ADSs representing the Shares, the Company will not be subject to the requirements of Part XVIIIA of the Companies Act (As Revised).

I confirm that you may continue to rely on this Certificate as being true and correct on the day that you issue the Opinion unless I shall have previously notified you personally to the contrary.

*[signature page follows]*



Signature: /s/ Yu-Hsin Lin  
Name: Yu-Hsin Lin  
Title: Director

---

## OPINION OF O'MELVENY &amp; MYERS LLP

April 5, 2022

Belite Bio, Inc  
5820 Oberlin Drive, Suite 101,  
San Diego, CA 92121  
United States of America

Re: American Depositary Shares (the "ADSs"), each representing 1 ordinary shares of Belite Bio, Inc. (the "Company").

Ladies and Gentlemen:

We have acted as counsel to the Company, a Cayman Islands company, in connection with the filing of a Registration Statement on Form F-1 (the "F-1 Registration Statement") with the Securities and Exchange Commission on April 5, 2022 (File No. 333-\_\_\_\_), for registration under the Securities Act of 1933, as amended (the "Act"), of ADSs in an initial public offering. Each ADS represents 1 ordinary shares, par value US\$ 0.0001 of the Company. You have requested our opinion concerning statements in the "Taxation — United States Federal Income Tax Considerations" section of the F-1 Registration Statement.

In our capacity as counsel to the Company, we have examined originals or copies of those corporate and other documents we considered appropriate, including the F-1 Registration Statement and the forms of agreements attached as exhibits thereto and such other records, documents, certificates or other instruments, and other written factual representations provided by the Company for us to rely on, as in our judgment were necessary or appropriate to enable us to render the opinion expressed below. We have assumed the genuineness of all signatures, the legal capacity of all natural persons, the authenticity of all documents submitted to us as originals and the conformity with originals of all documents submitted to us as copies. We have also assumed that the transactions described in the F-1 Registration Statement and the forms of agreements attached as exhibits thereto will be performed in the manner described therein. We have not made an independent investigation of documents submitted or facts represented to us.

On the basis of the foregoing and our consideration of those questions of law we considered relevant, and subject to the limitations, qualifications, and assumptions set forth in this opinion, we confirm that the discussion in the "Taxation — United States Federal Income Tax Considerations" section of the F-1 Registration Statement, to the extent that it constitutes matters of U.S. federal income tax law or legal conclusions relating to the U.S. federal income tax laws of the United States and subject to the qualifications therein, represents our opinion and constitutes accurate summaries of such matters in all material respects.

Our opinion is based on the existing provisions of the U.S. Internal Revenue Code of 1986, as amended, Treasury regulations thereunder (both final and proposed), and interpretations thereof by the Internal Revenue Service and the courts having jurisdictions over such matters and other applicable authorities in effect as of the date hereof. Our opinion is not binding upon the Internal Revenue Service or the courts, and there can be no assurance that the Internal Revenue Service will not assert a contrary position. Furthermore, no assurance can be given that future legislative, judicial or administrative changes, on either a prospective or retroactive basis, would not affect the conclusions stated in such opinion. We express no opinion with respect to the applicability, or the effect, of other U.S. federal laws, the laws of any state, the laws of any foreign country or any other jurisdiction or as to any matters of municipal law or the laws of any other local agencies within any state. No opinion is expressed as to any matter not discussed herein. Our opinion is rendered to the Company as of the date of this letter and we undertake no obligation to update it subsequent to the date of this letter. Any changes or differences in the facts from those disclosed in the F-1 Registration Statement will affect our opinion.

---

We consent to the Company's use of this opinion as an Exhibit to the F-1 Registration Statement, to the Company's reference to our name in the "Taxation" and "Legal Matters" sections of the F-1 Registration Statement and to the discussion of this opinion in the prospectus included in the F-1 Registration Statement. In giving such consent, we do not thereby concede that we are within the category of persons whose consent is required under Section 7 of the Act or the rules and regulations of the Securities and Exchange Commission thereunder.

Respectfully submitted,

/s/ O'Melveny & Myers LLP

---

**BELITE BIO, INC**  
**AMENDED AND RESTATED SHARE INCENTIVE PLAN**

**PREFACE**

*This Plan is divided into two separate equity programs: (1) the option and share appreciation rights grant program set forth in Section 5 under which Eligible Persons (as defined in Section 3) may, at the discretion of the Administrator, be granted Options and/or SARs, and (2) the share award program set forth in Section 6 under which Eligible Persons may, at the discretion of the Administrator, be awarded restricted or unrestricted Ordinary Shares. Section 2 of this Plan contains the general rules regarding the administration of this Plan. Section 3 sets forth the requirements for eligibility to receive an Award grant under this Plan. Section 4 describes the authorized shares of the Company that may be subject to Awards granted under this Plan. Section 7 contains other provisions applicable to all Awards granted under this Plan. Section 8 provides definitions for certain capitalized terms used in this Plan and not otherwise defined herein.*

**1. PURPOSE OF THE PLAN.**

The purpose of this Plan is to promote the success of the Company and the interests of its shareholders by providing a means through which the Company may grant equity-based incentives to attract, motivate, retain and reward certain officers, employees, directors and other eligible persons and to further link the interests of Award recipients with those of the Company's shareholders generally.

**2. ADMINISTRATION.**

**2.1 Administrator.** This Plan shall be administered by and all Awards under this Plan shall be authorized by the Administrator. The "**Administrator**" means the Board or one or more committees appointed by the Board or another committee (within its delegated authority) to administer all or certain aspects of this Plan. Any such committee shall be comprised solely of one or more directors or such number of directors as may be required under applicable law. A committee may delegate some or all of its authority to another committee so constituted. The Board or a committee comprised solely of directors may also delegate, to the extent permitted by the Companies Law, Cap 22 (Law 3 of 1961, as consolidated and revised) of the Cayman Islands and any other applicable law, to one or more officers of the Company, its powers under this Plan (a) to designate the officers and employees of the Company and its Affiliates who will receive grants of Awards under this Plan, and (b) to determine the number of shares subject to, and the other terms and conditions of, such Awards. The Board may delegate different levels of authority to different committees with administrative and grant authority under this Plan. Unless otherwise provided in the Memorandum and Articles of Association of the Company or the applicable charter of any Administrator, a majority of the members of the acting Administrator shall constitute a quorum, and the vote of a majority of the members present assuming the presence of a quorum or the unanimous written consent of the members of the Administrator shall constitute action by the acting Administrator.

**2.2 Plan Awards; Interpretation; Powers of Administrator.** Subject to the express provisions of this Plan, the Administrator is authorized and empowered to do all things necessary or desirable in connection with the authorization of Awards and the administration of this Plan (in the case of a committee or delegation to one or more officers, within the authority delegated to that committee or person(s)), including, without limitation, the authority to:

- (a) determine eligibility and, from among those persons determined to be eligible, the particular Eligible Persons who will receive Awards;
- (b) grant Awards to Eligible Persons, determine the price and number of securities to be offered or awarded to any of such persons, determine the other specific terms and conditions of Awards consistent with the express limits of this Plan, establish the installments (if any) in which such Awards will become exercisable or will vest (which may include, without limitation, performance and/or time-based schedules) or determine that no delayed exercisability or vesting is required, establish any applicable performance targets, and establish the events of termination or reversion of such Awards;
- (c) approve the forms of Award Agreements, which need not be identical either as to type of Award or among Participants;
- (d) construe and interpret this Plan and any Award Agreement or other agreements defining the rights and obligations of the Company, its Affiliates, and Participants under this Plan, make factual determinations with respect to the administration of this Plan, further define the terms used in this Plan, and prescribe, amend and rescind rules and regulations relating to the administration of this Plan or the Awards;
- (e) cancel, modify, or waive the Company's rights with respect to, or modify, discontinue, suspend, or terminate any or all outstanding Awards, subject to any required consent under Section 7.7.4;
- (f) accelerate or extend the vesting or exercisability or extend the term of any or all outstanding Awards (within the maximum ten-year term of Awards under Sections 5.4.2 and 6.5) in such circumstances as the Administrator may deem appropriate (including, without limitation, in connection with a termination of employment or services or other events of a personal nature);
- (g) determine Fair Market Value for purposes of this Plan and Awards;
- (h) determine the duration and purposes of leaves of absence that may be granted to Participants without constituting a termination of their employment for purposes of this Plan;
- (i) determine whether, and the extent to which, adjustments are required pursuant to Section 7.3 hereof and authorize the termination, conversion, substitution or succession of awards upon the occurrence of an event of the type described in Section 7.3; and
- (j) implement any procedures, steps, additional or different requirements as may be necessary to comply with any laws of the People's Republic of China (the "PRC") that may be applicable to this Plan, any Award or any related documents, including but not limited to foreign exchange laws, tax laws and securities laws of the PRC.

**2.3 Binding Determinations.** Any action taken by, or inaction of, the Company, any Affiliate, the Board or the Administrator relating or pursuant to this Plan and within its authority hereunder or under applicable law shall be within the absolute discretion of that entity or body and shall be conclusive and binding upon all persons. Neither the Board nor the Administrator, nor any member thereof or person acting at the direction thereof, shall be liable for any act, omission, interpretation, construction or determination made in good faith in connection with this Plan (or any Award), and all such persons shall be entitled to indemnification and reimbursement by the Company in respect of any claim, loss, damage or expense (including, without limitation, attorneys' fees) arising or resulting therefrom to the fullest extent permitted by law and/or under any directors and officers liability insurance coverage that may be in effect from time to time.

**2.4 Reliance on Experts.** In making any determination or in taking or not taking any action under this Plan, the Administrator may obtain and may rely upon the advice of experts, including employees of and professional advisors to the Company. No director, officer or agent of the Company or any of its Affiliates shall be liable for any such action or determination taken or made or omitted in good faith.

**2.5 Delegation.** The Administrator may delegate ministerial, non-discretionary functions to individuals who are officers or employees of the Company or any of its Affiliates or to third parties.

### **3. ELIGIBILITY.**

Awards may be granted under this Plan only to those persons that the Administrator determines to be Eligible Persons. An "**Eligible Person**" means any person who qualifies as one of the following at the time of grant of the respective Award:

- (a) an officer (whether or not a director) or employee of the Company or any of its Affiliates;
- (b) any member of the Board; or
- (c) any director of one of the Company's Affiliates, or any individual consultant or advisor who renders bona fide services (other than services in connection with the offering or sale of securities of the Company or one of its Affiliates, as applicable, in a capital raising transaction or as a market maker or promoter of that entity's securities) to the Company or one of its Affiliates.

An advisor or consultant may be selected as an Eligible Person pursuant to clause (c) above only if such person's participation in this Plan would not adversely affect (1) the Company's eligibility to rely on the Rule 701 exemption from registration under the Securities Act for the offering of shares issuable under this Plan by the Company, or (2) the Company's compliance with any other applicable laws.

An Eligible Person may, but need not, be granted one or more Awards pursuant to Section 5 and/or one or more Awards pursuant to Section 6. An Eligible Person who has been granted an Award under this Plan may, if otherwise eligible, be granted additional Awards under this Plan if the Administrator so determines. However, a person's status as an Eligible Person is not a commitment that any Award will be granted to that person under this Plan. Furthermore, an Eligible Person who has been granted an Award under Section 5 is not necessarily entitled to an Award under Section 6, or vice versa, unless otherwise expressly determined by the Administrator.

Each Award granted under this Plan must be approved by the Administrator at or prior to the grant of the Award.

**4. SHARES SUBJECT TO THE PLAN.**

**4.1 *Shares Available.*** Subject to the provisions of Section 7.3.1, the shares that may be delivered under this Plan will be the Company's authorized but unissued Ordinary Shares (and any of its Ordinary Shares held as treasury shares). The Ordinary Shares issued and delivered may be issued and delivered for any lawful consideration.

**4.2 *Share Limit.*** Subject to the provisions of Section 7.3.1 and further subject to the share counting rules of Section 4.3, the maximum number of Ordinary Shares that may be delivered pursuant to Awards granted under this Plan will not exceed 4,165,310 shares (the "**Share Limit**") in the aggregate. As required under U.S. Treasury Regulation Section 1.422-2(b)(3)(i), in no event will the number of Ordinary Shares that may be delivered pursuant to Incentive Stock Options granted under this Plan exceed the Share Limit.

**4.3 *Replenishment and Reissue of Unvested Awards.*** To the extent that an Award is settled in cash or a form other than Ordinary Shares, the shares that would have been delivered had there been no such cash or other settlement shall not be counted against the shares available for issuance under this Plan. No Award may be granted under this Plan unless, on the date of grant, the sum of (a) the maximum number of Ordinary Shares issuable at any time pursuant to such Award, plus (b) the number of Ordinary Shares that have previously been issued pursuant to Awards granted under this Plan, plus (c) the maximum number of Ordinary Shares that may be issued at any time after such date of grant pursuant to Awards that are outstanding on such date, does not exceed the Share Limit. Ordinary Shares that are subject to or underlie Options or SARs granted under this Plan that expire or for any reason are canceled or terminated without having been exercised (or Ordinary Shares subject to or underlying the unexercised portion of such Options or SARs in the case of Options or SARs that were partially exercised), as well as Ordinary Shares that are subject to Share Awards made under this Plan that are forfeited to the Company or otherwise repurchased by the Company prior to the vesting of such shares for a price not greater than the original purchase or issue price of such shares (as adjusted pursuant to Section 7.3.1) will again, except to the extent prohibited by law or applicable listing or regulatory requirements, be available for subsequent Award grants under this Plan. Shares that are exchanged by a Participant or withheld by the Company as full or partial payment in connection with any Award under this Plan, as well as any shares exchanged by a Participant or withheld by the Company or one of its Affiliates to satisfy the tax withholding obligations related to any Award, shall be available for subsequent Awards under this Plan. In the case of an exercise of a SAR, only the number of shares actually issued in respect of such exercise shall be charged against this Plan's Share Limit. Adjustments to the Share Limit pursuant to this Section 4.3 are subject to any applicable limitations of the Code in the case of Awards intended to be Incentive Stock Options.

**4.4 *Reservation of Shares.*** The Company shall at all times reserve a number of Ordinary Shares sufficient to cover the Company's obligations and contingent obligations to deliver shares with respect to Awards then outstanding under this Plan.

**5. OPTION AND SAR GRANT PROGRAM.**

**5.1 Option and SAR Grants in General.** Each Option or SAR shall be evidenced by an Award Agreement in the form approved by the Administrator. The Award Agreement evidencing an Option or SAR shall contain the terms established by the Administrator for that Award, as well as any other terms, provisions, or restrictions that the Administrator may impose on the Option or SAR or any Ordinary Shares subject to the Option or SAR; in each case subject to the applicable provisions and limitations of this Section 5 and the other applicable provisions and limitations of this Plan. The Administrator may require that the recipient of an Option or SAR promptly execute and return to the Company his or her Award Agreement evidencing the Award. In addition, the Administrator may require that the spouse of any married recipient of an Option or SAR also promptly execute and return to the Company the Award Agreement evidencing the Award granted to the recipient or such other spousal consent form that the Administrator may require in connection with the grant of the Award.

**5.2 Incentive Stock Option Status.** The Administrator will designate each Option granted under this Plan to a U.S. resident as either an Incentive Stock Option or a Nonqualified Option, and such designation shall be set forth in the applicable Award Agreement. Any Option granted under this Plan to a U.S. resident that is not expressly designated in the applicable Award Agreement as an Incentive Stock Option will be deemed to be designated a Nonqualified Option under this Plan and not an “incentive stock option” within the meaning of Section 422 of the Code. Incentive Stock Options shall be subject to the provisions of Section 5.5 in addition to the provisions of this Plan applicable to Options generally. The Administrator may designate any Option granted under this Plan to a non-U.S. resident in accordance with the rules and regulations applicable to options in the jurisdiction in which such person is a resident.

**5.3 Option or SAR Price.**

**5.3.1 Option Pricing Limits.** Subject to the following provisions of this Section 5.3.1, the Administrator will determine the purchase price per share of the Ordinary Shares covered by each Option (the “exercise price” of the Option) at the time of the grant of the Option, which exercise price will be set forth in the applicable Award Agreement. In no case will the exercise price of an Option be less than the greatest of:

- (a) the par value of an Ordinary Share;
- (b) subject to clause (c) below, 100% of the Fair Market Value of an Ordinary Share on the date of grant; or
- (c) in the case of an Incentive Stock Option granted to a Participant described in Section 5.5.4, 110% of the Fair Market Value of an Ordinary Share on the date of grant.



**5.3.2 Payment Provisions.** The Company will not be obligated to deliver certificates for the Ordinary Shares to be purchased upon the exercise of an Option unless and until it receives full payment of the exercise price therefor, all related withholding obligations under Section 7.6 have been satisfied, and all other conditions to the exercise of the Option set forth herein or in the Award Agreement have been satisfied. The purchase price of any Ordinary Shares purchased upon the exercise of an Option must be paid in full at the time of each purchase in such lawful consideration as may be permitted or required by the Administrator, which may include, without limitation, one or a combination of the following methods:

- (a) cash, check payable to the order of the Company, or electronic funds transfer;
- (b) notice and third party payment in such manner as may be authorized by the Administrator;
- (c) the delivery of previously owned Ordinary Shares;
- (d) by a reduction in the number of Ordinary Shares otherwise deliverable pursuant to the Award;
- (e) subject to such procedures as the Administrator may adopt, pursuant to a “cashless exercise”; or
- (f) if authorized by the Administrator or specified in the applicable Award Agreement, by a promissory note of the Participant consistent with the requirements of Section 5.3.3.

In no event shall any shares newly-issued by the Company be issued for less than the minimum lawful consideration for such shares or for consideration other than consideration permitted by applicable law. Ordinary Shares used to satisfy the exercise price of an Option (whether previously-owned shares or shares otherwise deliverable pursuant to the terms of the Option) shall be valued at their Fair Market Value on the date of exercise. Unless otherwise expressly provided in the applicable Award Agreement, the Administrator may eliminate or limit a Participant’s ability to pay the purchase or exercise price of any Award by any method other than cash payment to the Company. The Administrator may take all actions necessary to alter the method of Option exercise and the exchange and transmittal of proceeds with respect to Participants resident in the PRC not having permanent residence in a country other than the PRC in order to comply with applicable PRC foreign exchange and tax regulations and any other applicable PRC laws and regulations.

**5.3.3** Acceptance of Notes to Finance Exercise. The Company may, with the Administrator's approval in each specific case, accept one or more promissory notes from any Eligible Person in connection with the exercise of any Option; provided that any such note shall be subject to the following terms and conditions:

- (a) The principal of the note shall not exceed the amount required to be paid to the Company upon the exercise, purchase or acquisition of one or more Awards under this Plan and the note shall be delivered directly to the Company in consideration of such exercise, purchase or acquisition.
- (b) The initial term of the note shall be determined by the Administrator; provided that the term of the note, including extensions, shall not exceed a period of five years.
- (c) The note shall provide for full recourse to the Participant and shall bear interest at a rate determined by the Administrator, but not less than the interest rate necessary to avoid the imputation of interest under the Code or other applicable tax law, rules or regulations, and to avoid any adverse accounting consequences in connection with the exercise, purchase or acquisition.
- (d) If the employment or services of the Participant by or to the Company and its Affiliates terminates, the unpaid principal balance of the note shall become due and payable on the 30th business day after such termination; provided, however, that if a sale of the shares acquired on exercise of the Option would cause such Participant to incur liability under Section 16(b) of the Exchange Act, the unpaid balance shall become due and payable on the 10th business day after the first day on which a sale of such shares could have been made without incurring such liability assuming for these purposes that there are no other transactions (or deemed transactions) in securities of the Company by the Participant subsequent to such termination.
- (e) If required by the Administrator or by applicable law, the note shall be secured by a pledge of any shares or rights financed thereby or other collateral, in compliance with applicable law.

The terms, repayment provisions, and collateral release provisions of the note and the pledge securing the note shall conform with all applicable rules and regulations, including those of the Federal Reserve Board of the United States and any applicable law, as then in effect.

**5.3.4** Base Price of SARs. The Administrator will determine the base price per share of the Ordinary Shares covered by each SAR at the time of the grant of the SAR, which base price will be set forth in the applicable Award Agreement and will not be less than 100% of the Fair Market Value of an Ordinary Share on the date of grant of the SAR.

**5.4 *Vesting; Term; Exercise Procedure.***

**5.4.1 Vesting.** Except as provided in Section 5.8, an Option or SAR may be exercised only to the extent that it is vested and exercisable. The Administrator will determine the vesting and/or exercisability provisions of each Option or SAR (which may be based on performance criteria, passage of time or other factors or any combination thereof), which provisions will be set forth in the applicable Award Agreement. Unless the Administrator otherwise expressly provides, once exercisable an Option or SAR will remain exercisable until the expiration or earlier termination of the Option or SAR.

**5.4.2 Term.** Each Option and SAR shall expire not more than 10 years after its date of grant. Each Option and SAR will be subject to earlier termination as provided in or pursuant to Sections 5.6 and 7.3 or the terms of the applicable Award Agreement.

**5.4.3 Exercise Procedure.** Any exercisable Option or SAR will be deemed to be exercised when (a) the applicable exercise procedures in the related Award Agreement have been satisfied (or, in the absence of any such procedures in the related Award Agreement, the Company has received written notice of such exercise from the Participant), (b) in the case of an Option, the Company has received any required payment made in accordance with Section 5.3, (c) in the case of an Option or SAR, all withholding obligations arising in connection with the exercise have been satisfied in accordance with Section 7.6, and (d) in the case of an Option or SAR, the Company has received any written statement required pursuant to Section 7.5.1.

**5.4.4 Fractional Shares/Minimum Issue.** Fractional share interests will be disregarded, but may be accumulated. The Administrator, however, may determine that cash, other securities, or other property will be paid or transferred in lieu of any fractional share interests. No Option or SAR may be exercised as to fewer than 100 shares (subject to adjustment pursuant to Section 7.3.1) at one time unless the number as to which the Award is exercised is the total number at the time then subject to the vested and exercisable portion of the Award.

**5.5 *Limitations on Grant and Terms of Incentive Stock Options.***

**5.5.1 US\$100,000 Limit.** To the extent that the aggregate Fair Market Value of shares with respect to which incentive stock options (within the meaning of Section 422 of the Code) first become exercisable by a Participant in any calendar year exceeds US\$100,000, taking into account both Ordinary Shares subject to Incentive Stock Options under this Plan and shares subject to incentive stock options under all other plans of the Company or any of its Affiliates, such options will be treated as Nonqualified Options. For this purpose, the Fair Market Value of the shares subject to options will be determined as of the date the options were awarded. In reducing the number of options treated as incentive stock options to meet the US\$100,000 limit, the most recently granted options will be reduced (recharacterized as Nonqualified Options) first. To the extent a reduction of simultaneously granted options is necessary to meet the US\$100,000 limit, the Administrator may, in the manner and to the extent permitted by law, designate which Ordinary Shares are to be treated as shares acquired pursuant to the exercise of an incentive stock option.

**5.5.2 Other Code Limits.** Incentive Stock Options may only be granted to individuals that are employees of the Company or one of its Affiliates and satisfy the other eligibility requirements of the Code. Any Award Agreement relating to Incentive Stock Options will contain or shall be deemed to contain such other terms and conditions as from time to time are required in order that the Option be an "incentive stock option" as that term is defined in Section 422 of the Code.

**5.5.3** ISO Notice of Sale Requirement. Any Participant who exercises an Incentive Stock Option shall give prompt written notice to the Company of any sale or other transfer of the Ordinary Shares acquired on such exercise if the sale or other transfer occurs within (a) one year after the exercise date of the Option, or (b) two years after the grant date of the Option.

**5.5.4** Limits on 10% Holders. No Incentive Stock Option may be granted to any person who, at the time the Incentive Stock Option is granted, owns (or is deemed to own under Section 424(d) of the Code) outstanding shares of the Company (or any of its Affiliates) possessing more than 10% of the total combined voting power of all classes of shares of the Company (or any of its Affiliates), unless the exercise price of such Incentive Stock Option is at least 110% of the Fair Market Value of the shares subject to the Incentive Stock Option and the Incentive Stock Option by its terms is not exercisable more than five years after the date the Incentive Stock Option is granted.

**5.6** *Effects of Termination of Employment on Options and SARs.*

**5.6.1** Dismissal for Cause. Unless otherwise provided in the applicable Award Agreement and subject to earlier termination pursuant to or as contemplated by Section 5.4.2 or 7.3, if a Participant's employment by or service to the Company or any of its Affiliates is terminated by such entity for Cause, the Participant's Option or SAR will terminate on the Participant's Severance Date, whether or not the Option or SAR is then vested and/or exercisable.

**5.6.2** Death or Disability. Unless otherwise provided in the applicable Award Agreement (consistent with applicable securities laws) and subject to earlier termination pursuant to or as contemplated by Section 5.4.2 or 7.3, if a Participant's employment by or service to the Company or any of its Affiliates terminates as a result of the Participant's death or Total Disability:

- (a) the Participant (or his or her Personal Representative or Beneficiary, in the case of the Participant's Total Disability or death, respectively), will have until the date that is 12 months after the Participant's Severance Date to exercise the Participant's Option or SAR (or portion thereof) to the extent that it was vested and exercisable on the Severance Date;
- (b) the Option or SAR, to the extent not vested and exercisable on the Participant's Severance Date, shall terminate on the Severance Date; and
- (c) the Option or SAR, to the extent exercisable for the 12-month period following the Participant's Severance Date and not exercised during such period, shall terminate at the close of business on the last day of the 12-month period.

**5.6.3 Other Terminations of Employment.** Unless otherwise provided in the applicable Award Agreement (consistent with applicable securities laws) and subject to earlier termination pursuant to or as contemplated by Section 5.4.2 or 7.3, if a Participant's employment by or service to the Company or any of its Affiliates terminates for any reason other than a termination by such entity for Cause or because of the Participant's death or Total Disability:

- (a) the Participant will have until the date that is 3 months after the Participant's Severance Date to exercise his or her Option or SAR (or portion thereof) to the extent that it was vested and exercisable on the Severance Date;
- (b) the Option or SAR, to the extent not vested and exercisable on the Participant's Severance Date, shall terminate on the Severance Date; and
- (c) the Option or SAR, to the extent exercisable for the 3-month period following the Participant's Severance Date and not exercised during such period, shall terminate at the close of business on the last day of the 3-month period.

**5.7 Option and SAR repricing/Cancellation and Regrant/Waiver of Restrictions.** Subject to Section 4 and Section 7.7 and the specific limitations on Options and SARs contained in this Plan, the Administrator from time to time may authorize, generally or in specific cases only, for the benefit of any Eligible Person, any adjustment in the exercise or base price, the vesting schedule, the number of shares subject to, or the term of, an Option or SAR granted under this Plan by cancellation of an outstanding Option or SAR and a subsequent regranting of the Option or SAR, by amendment, by substitution of an outstanding Option or SAR, by waiver or by other legally valid means. Such amendment or other action may result in, among other changes, an exercise or base price that is higher or lower than the exercise or base price of the original or prior Option or SAR, provide for a greater or lesser number of Ordinary Shares subject to the Option or SAR, or provide for a longer or shorter vesting or exercise period. In no event, however, may any such amendment or other action reduce the exercise or base price of the Option or SAR to less than the Fair Market Value of an Ordinary Share at the time of such change, or extend the maximum term of the Option or SAR at a time when the exercise or base price of such Award is less than the Fair Market Value of an Ordinary Share.

**5.8 Early Exercise Options and SARs.** The Administrator may, in its discretion, designate any Option or SAR as an "early exercise Option" or "early exercise SAR" which, by express provision in the applicable Award Agreement, may be exercised prior to the date such Option or SAR has vested. If the Participant elects to exercise all or a portion of an early exercise Option or SAR before it is vested, the Ordinary Shares acquired under the Option or SAR which are attributable to the unvested portion of the Option or SAR shall be Restricted Shares. The applicable Award Agreement will specify the extent (if any) to which and the time (if ever) at which the Participant will be entitled to dividends, voting and other rights in respect of such Restricted Shares prior to vesting, and the restrictions imposed on such shares and the conditions of release or lapse of such restrictions. Unless otherwise expressly provided in the applicable Award Agreement, such Restricted Shares shall be subject to the provisions of Sections 6.6 through 6.9, below.

## 6. SHARE AWARD PROGRAM.

**6.1 *Share Awards in General.*** Each Share Award shall be evidenced by an Award Agreement in the form approved by the Administrator. The Award Agreement evidencing a Share Award shall contain the terms established by the Administrator for that Share Award, as well as any other terms, provisions, or restrictions that the Administrator may impose on the Share Award; in each case subject to the applicable provisions and limitations of this Section 6 and the other applicable provisions and limitations of this Plan. The Administrator may require that the recipient of a Share Award promptly execute and return to the Company his or her Award Agreement evidencing the Share Award. In addition, the Administrator may require that the spouse of any married recipient of a Share Award also promptly execute and return to the Company the Award Agreement evidencing the Share Award granted to the recipient or such other spousal consent form that the Administrator may require in connection with the grant of the Share Award.

**6.2 *Types of Share Awards.*** The Administrator shall designate whether a Share Award shall be a Restricted Share Award, and such designation shall be set forth in the applicable Award Agreement.

### **6.3 *Purchase Price.***

**6.3.1 *Pricing Limits.*** Subject to the following provisions of this Section 6.3, the Administrator will determine the purchase price per share of the Ordinary Shares covered by each Share Award at the time of grant of the Award. In no case will such purchase price be less than the par value of the Ordinary Shares.

**6.3.2 *Payment Provisions.*** The Company will not be obligated to record in the Company's register of members, or issue certificates evidencing, Ordinary Shares awarded under this Section 6 unless and until it receives full payment of the purchase price therefor and all other conditions to the purchase, as determined by the Administrator, have been satisfied, at which point the relevant shares shall be issued and noted in the Company's register of members. The purchase price of any shares subject to a Share Award must be paid in full at the time of the purchase in such lawful consideration as may be permitted or required by the Administrator, which may include, without limitation, one or a combination of the methods set forth in clauses (a) through (f) in Section 5.3.2 and/or past services rendered to the Company or any of its Affiliates.

**6.4 *Vesting.*** The restrictions imposed on the Ordinary Shares subject to a Restricted Share Award (which may be based on performance criteria, passage of time or other factors or any combination thereof) will be set forth in the applicable Award Agreement.

**6.5 *Term; Settlement of Awards.*** A Share Award shall either vest or be forfeited not more than 10 years after the date of grant. Each Share Award will be subject to earlier termination as provided in or pursuant to Sections 6.8 and 7.3. Payment of Awards may be in the form of cash, Ordinary Shares, other Awards or combinations thereof as the Administrator shall determine, and with such restrictions as it may impose. The Administrator may also require or permit Participants to elect to defer the issuance of shares or the settlement of Awards in cash under such rules and procedures as it may establish under this Plan. The Administrator may also provide that deferred settlements include the payment or crediting of interest or other earnings on the deferral amounts, or the payment or crediting of dividend equivalents where the deferred amounts are denominated in shares.

**6.6 Share Certificates; Fractional Shares.** Share certificates evidencing Restricted Shares will bear a legend making appropriate reference to the restrictions imposed hereunder and will be held by the Company or by a third party designated by the Administrator until the restrictions on such shares have lapsed, the shares have vested in accordance with the provisions of the Award Agreement and Section 6.4, and any related loan has been repaid. Fractional share interests will be disregarded, but may be accumulated. The Administrator, however, may determine that cash, other securities, or other property will be paid or transferred in lieu of any fractional share interests.

**6.7 Dividend and Voting Rights.** Unless otherwise provided in the applicable Award Agreement, a Participant holding Restricted Shares will be entitled to cash dividend and voting rights for all Restricted Shares issued even though they are not vested, but such rights will terminate immediately as to any Restricted Shares which cease to be eligible for vesting or are repurchased by the Company.

**6.8 Termination of Employment; Return to the Company.** Unless the Administrator otherwise expressly provides, Restricted Shares subject to an Award that remain subject to vesting conditions that have not been satisfied by the time specified in the applicable Award Agreement (which may include, without limitation, the Participant's Severance Date), will not vest and will be reacquired by the Company in such manner and on such terms as the Administrator provides, which terms shall include, to the extent not prohibited by law, return or repayment of the lower of (a) the Fair Market Value of the Restricted Shares at the time of the termination, or (b) if applicable, the original purchase price of the Restricted Shares, without interest. The Award Agreement shall specify any other terms or conditions of the repurchase if the Award fails to vest. Any other Share Award that has not been exercised as of a Participant's Severance Date shall terminate on that date unless otherwise expressly provided by the Administrator in the applicable Award Agreement.

**6.9 Waiver of Restrictions.** Subject to Sections 4 and 7.7 and the specific limitations on Share Awards contained in this Plan, the Administrator from time to time may authorize, generally or in specific cases only, for the benefit of any Eligible Person, any adjustment in the vesting schedule, or the restrictions upon or the term of, a Share Award granted under this Plan by amendment, by substitution of an outstanding Share Award, by waiver or by other legally valid means.

7. **PROVISIONS APPLICABLE TO ALL AWARDS.**

7.1 ***Rights of Eligible Persons, Participants and Beneficiaries.***

7.1.1 **Employment Status.** No Person shall have any claim or rights to be granted an Award (or additional Awards, as the case may be) under this Plan, subject to any express contractual rights (set forth in a document other than this Plan) to the contrary.

7.1.2 **No Employment/Service Contract.** Nothing contained in this Plan (or in any other documents under this Plan or related to any Award) shall confer upon any Eligible Person or Participant any right to continue in the employ or other service of the Company or any of its Affiliates, constitute any contract or agreement of employment or other service or affect an employee's status as an employee at will, nor shall interfere in any way with the right of the Company or any Affiliate to change such person's compensation or other benefits, or to terminate his or her employment or other service, with or without cause at any time. Nothing in this Section 7.1.2, or in Section 7.3 or 7.15, however, is intended to adversely affect any express independent right of such person under a separate employment or service contract. An Award Agreement shall not constitute a contract of employment or service.

7.1.3 **Plan Not Funded.** Awards payable under this Plan will be payable in Ordinary Shares or from the general assets of the Company, and (except as to the share reservation provided in Section 4.4) no special or separate reserve, fund or deposit will be made to assure payment of such Awards. No Participant, Beneficiary or other person will have any right, title or interest in any fund or in any specific asset (including Ordinary Shares, except as expressly provided) of the Company or any of its Affiliates by reason of any Award hereunder. Neither the provisions of this Plan (or of any related documents), nor the creation or adoption of this Plan, nor any action taken pursuant to the provisions of this Plan will create, or be construed to create, a trust of any kind or a fiduciary relationship between the Company or any of its Affiliates and any Participant, Beneficiary or other person. To the extent that a Participant, Beneficiary or other person acquires a right to receive payment pursuant to any Award hereunder, such right will be no greater than the right of any unsecured general creditor of the Company.

7.1.4 **Charter Documents.** The Memorandum and Articles of Association of the Company, as may lawfully be amended from time to time, may provide for additional restrictions and limitations with respect to the Ordinary Shares (including additional restrictions and limitations on the voting or transfer of Ordinary Shares) or priorities, rights and preferences as to securities and interests prior in rights to the Ordinary Shares. These restrictions and limitations are in addition to (and not in lieu of) those set forth in this Plan or any Award Agreement and are incorporated herein by this reference.

7.2 ***No Transferability; Limited Exception to Transfer Restrictions.***

7.2.1 **Limit on Exercise and Transfer.** Unless otherwise expressly provided in (or pursuant to) this Section 7.2, by applicable law and by the Award Agreement, as the same may be amended:

- (a) all Awards are non-transferable and will not be subject in any manner to sale, transfer, anticipation, alienation, assignment, pledge, encumbrance or charge;
- (b) Awards will be exercised only by the Participant; and
- (c) amounts payable or shares issuable pursuant to an Award will be delivered only to (or for the account of), and, in the case of Ordinary Shares, registered in the name of, the Participant.

In addition, the shares shall be subject to the restrictions set forth in the applicable Award Agreement.



7.2.2 Further Exceptions to Limits on Transfer. The exercise and transfer restrictions in Section 7.2.1 will not apply to:

- (a) transfers to the Company;
- (b) transfers by gift or domestic relations order to one or more “family members” (as that term is defined in SEC Rule 701 promulgated under the Securities Act) of the Participant, including transfers to a trust in which the Participant (or other family member) has more than 50% of the beneficial interest, a foundation in which the Participant (or other family member) controls the management of assets, or an entity in which the Participant (or other family member) owns more than 50% of the voting interest, so long as such transfer is expressly authorized by the Administrator and is in compliance with all applicable laws;
- (c) the designation of a Beneficiary to receive benefits if the Participant dies or, if the Participant has died, transfers to or exercises by the Participant’s Beneficiary, or, in the absence of a validly designated Beneficiary, transfers by will or the laws of descent and distribution; or
- (d) if the Participant has suffered a disability, permitted transfers or exercises on behalf of the Participant by the Participant’s duly authorized legal representative.

Notwithstanding anything else in this Section 7.2.2 to the contrary, but subject to compliance with all applicable laws, Incentive Stock Options and Restricted Share Awards will be subject to any and all transfer restrictions under the Code applicable to such awards or necessary to maintain the intended tax consequences of such Awards. Notwithstanding clause (b) above but subject to compliance with all applicable laws, any contemplated transfer by gift or domestic relations order to one or more family members of a Participant as referenced in clause (b) above is subject to the condition precedent that the transfer be approved by the Administrator in order for it to be effective. The Administrator may, in its sole discretion, withhold its approval of any such proposed transfer.

### 7.3 *Adjustments; Changes in Control.*

**7.3.1 Adjustments.** Subject to Section 7.3.2 below, upon (or, as may be necessary to effect the adjustment, immediately prior to) any reclassification, recapitalization, share split (including a share split in the form of a share dividend) or reverse share split; any merger, combination, consolidation, or other reorganization; any split-up, spin-off, or similar extraordinary dividend distribution in respect of the Ordinary Shares; or any exchange of Ordinary Shares or other securities of the Company, or any similar, unusual or extraordinary corporate transaction in respect of the Ordinary Shares; then the Administrator shall equitably and proportionately adjust (1) the number and type of shares of Ordinary Shares (or other securities) that thereafter may be made the subject of Awards (including the specific share limits, maximums and numbers of shares set forth elsewhere in this Plan), (2) the number, amount and type of Ordinary Shares (or other securities or property) subject to any outstanding Awards, (3) the grant, purchase, exercise or base price of any outstanding Awards, and/or (4) the securities, cash or other property deliverable upon exercise or vesting of any outstanding Awards, in each case to the extent necessary to preserve (but not increase) the level of incentives intended by this Plan and the then-outstanding Awards.

Unless otherwise expressly provided in the applicable Award Agreement, upon (or, as may be necessary to effect the adjustment, immediately prior to) any event or transaction described in the preceding paragraph or a sale of all or substantially all of the business or assets of the Company as an entirety, the Administrator shall equitably and proportionately adjust the performance standards applicable to any then-outstanding performance-based Awards to the extent necessary to preserve (but not increase) the level of incentives intended by this Plan and the then-outstanding performance-based Awards.

It is intended that, if possible, any adjustments contemplated by the preceding two paragraphs be made in a manner that satisfies applicable legal, tax (including, without limitation and as applicable in the circumstances, Sections 409A, 424 and 457A of the Code) and accounting (so as to not trigger any charge to earnings with respect to such adjustment) requirements.

Without limiting the generality of Section 2.3, any good faith determination by the Administrator as to whether an adjustment is required in the circumstances pursuant to this Section 7.3.1, and the extent and nature of any such adjustment, shall be conclusive and binding on all persons.

Unless otherwise expressly provided by the Administrator, in no event shall a conversion of one or more outstanding shares of the Company's preferred share (if any) or any new issuance of securities by the Company for consideration be deemed, in and of itself, to require an adjustment pursuant to this Section 7.3.1.

**7.3.2 Consequences of a Change in Control Event.** Upon the occurrence of a Change in Control Event, the Administrator may make provision for a cash payment in settlement of, or for the assumption, substitution or exchange of any or all outstanding Awards (or the cash, securities or other property deliverable to the holder(s) of any or all outstanding Awards) based upon, to the extent relevant in the circumstances, the distribution or consideration payable to holders of the Ordinary Shares upon or in respect of such event.

The Administrator may, in its sole discretion, provide in the applicable Award Agreement or by an amendment thereto for the accelerated vesting of one or more Awards to the extent such Awards are outstanding upon a Change in Control Event or such other events or circumstances as the Administrator may provide.

The Administrator may adopt such valuation methodologies for outstanding Awards as it deems reasonable in the event of a cash, securities or other property settlement. In the case of Options and SARs, but without limitation on other methodologies, the Administrator may base such settlement solely upon the excess (if any) of the amount payable upon or in respect of such event over the exercise or base price of the Option or SAR, as applicable, to the extent of the then vested and exercisable shares subject to the Option or SAR.

In any of the events referred to in this Section 7.3.2, the Administrator may take such action contemplated by this Section 7.3.2 prior to such event (as opposed to on the occurrence of such event) to the extent that the Administrator deems the action necessary to permit the Participant to realize the benefits intended to be conveyed with respect to the underlying shares. Without limiting the generality of the foregoing, the Administrator may deem an acceleration to occur immediately prior to the applicable event and/or reinstate the original terms of the Award if an event giving rise to an acceleration does not occur.

**7.3.3** Early Termination of Awards. Upon the occurrence of a Change in Control Event, each then-outstanding Award (whether or not vested and/or exercisable) shall terminate, subject to any provision that has been expressly made by the Administrator, through a plan of reorganization or otherwise, for the survival, substitution, assumption, exchange or other continuation or settlement of such Award and provided that, in the case of Options and SARs that will not survive or be substituted for, assumed, exchanged, or otherwise continued or settled in the Change in Control Event, the holder of such Award shall be given reasonable advance notice of the impending termination and a reasonable opportunity to exercise his or her outstanding and vested Options and SARs in accordance with their terms before the termination of the Awards (except that in no case shall more than ten days' notice of the impending termination be required). For purposes of this Section 7.3, an Award shall be deemed to have been "assumed" if (without limiting other circumstances in which an Award is assumed) the Award continues after the Change in Control Event, and/or is assumed and continued by a Parent (as such term is defined in the definition of Change in Control Event) following a Change in Control Event, and confers the right to purchase or receive, as applicable and subject to vesting and the other terms and conditions of the Award, for each Ordinary Share subject to the Award immediately prior to the Change in Control Event, the consideration (whether cash, shares, or other securities or property) received in the Change in Control Event by the shareholders of the Company for each Ordinary Share sold or exchanged in such transaction (or the consideration received by a majority of the shareholders participating in such transaction if the shareholders were offered a choice of consideration);

provided, however, that if the consideration offered for an Ordinary Share in the transaction is not solely the ordinary or common shares of a successor company or a Parent, the Administrator may provide for the consideration to be received upon exercise or payment of the Award, for each share subject to the Award, to be solely ordinary or common shares (as applicable) of the successor company or a Parent equal in Fair Market Value to the per share consideration received by the shareholders participating in the Change in Control Event.

**7.3.4** Other Acceleration Rules. The Administrator may override the provisions of this Section 7.3 as to any Award by express provision in the applicable Award Agreement and may accord any Participant a right to refuse any acceleration, whether pursuant to the Award Agreement or otherwise, in such circumstances as the Administrator may approve. The portion of any Incentive Stock Option accelerated in connection with a Change in Control Event (or such other circumstances as may trigger accelerated vesting of the Incentive Stock Option) shall remain exercisable as an Incentive Stock Option only to the extent the applicable US\$100,000 limitation on Incentive Stock Options is not exceeded. To the extent exceeded, the accelerated portion of the Option shall be exercisable as a Nonqualified Option.

**7.4** *Termination of Employment or Services.*

**7.4.1** Events Not Deemed a Termination of Employment. Unless the Administrator otherwise expressly provides with respect to a particular Award, if a Participant's employment by or service to the Company or an Affiliate terminates but immediately thereafter the Participant continues in the employ of or service to another Affiliate or the Company, as applicable, the Participant shall be deemed to have not had a termination of employment or service for purposes of this Plan and the Participant's Awards. Unless the express policy of the Company or the Administrator otherwise provides, a Participant's employment relationship with the Company or any of its Affiliates shall not be considered terminated solely due to any sick leave, military leave, or any other leave of absence authorized by the Company or any Affiliate or the Administrator; provided that, unless reemployment upon the expiration of such leave is guaranteed by contract or law, such leave is for a period of not more than three months. In the case of any Participant on an approved leave of absence, continued vesting of the Award while on leave from the employ of or service with the Company or any of its Affiliates will be suspended until the Participant returns to service, unless the Administrator otherwise provides or applicable law otherwise requires. In no event shall an Award be exercised after the expiration of the term of the Award set forth in the Award Agreement.

**7.4.2** Effect of Change of Affiliate Status. For purposes of this Plan and any Award, if an entity ceases to be an Affiliate, a termination of employment or service will be deemed to have occurred with respect to each Eligible Person in respect of such Affiliate who does not continue as an Eligible Person in respect of another Affiliate that continues as such after giving effect to the transaction or other event giving rise to the change in status unless the Affiliate that is sold, spun-off or otherwise divested (or its successor or a direct or indirect parent of such Affiliate or successor) assumes the Eligible Person's award(s) in connection with such transaction.

**7.4.3** Administrator Discretion. Notwithstanding the provisions of Section 5.6 or 6.8, in the event of, or in anticipation of, a termination of employment or service with the Company or any of its Affiliates for any reason, the Administrator may accelerate the vesting and exercisability of all or a portion of the Participant's Award, and/or, subject to the provisions of Sections 5.4.2 and 7.3, extend the exercisability period of the Participant's Option or SAR upon such terms as the Administrator determines and expressly sets forth in or by amendment to the Award Agreement.

**7.4.4** Termination of Consulting or Affiliate Services. If the Participant is an Eligible Person solely by reason of clause (c) of Section 3, the Administrator shall be the sole judge of whether the Participant continues to render services to the Company or any of its Affiliates, unless a written contract or the Award Agreement otherwise provides.

**7.5** *Compliance with Laws.*

**7.5.1** General. This Plan, the granting and vesting of Awards under this Plan, and the offer, issuance and delivery of Ordinary Shares, the acceptance of promissory notes and/or the payment of money under this Plan or under Awards are subject to compliance with all applicable federal and state laws, applicable foreign laws, rules and regulations (including but not limited to state and federal securities laws, and federal margin requirements) and to such approvals by any listing, regulatory or governmental authority as may, in the opinion of counsel for the Company, be necessary or advisable in connection therewith. Any person acquiring any securities under this Plan will, if requested by the Company, provide such assurances and representations to the Company as the Administrator may deem necessary or desirable to assure compliance with all applicable legal and accounting requirements.

**7.5.2** Compliance with Securities Laws. No Participant shall sell, pledge or otherwise transfer Ordinary Shares acquired pursuant to an Award or any interest in such shares except in accordance with the express terms of this Plan and the applicable Award Agreement. Any attempted transfer in violation of this Section 7.5 shall be void and of no effect. Without in any way limiting the provisions set forth above, no Participant shall make any disposition of all or any portion of Ordinary Shares acquired or to be acquired pursuant to an Award, except in compliance with all applicable federal and state securities laws and unless and until:

- (a) there is then in effect a registration statement under the Securities Act covering such proposed disposition and such disposition is made in accordance with such registration statement;
- (b) such disposition is made in accordance with Rule 144 under the Securities Act; or
- (c) such Participant notifies the Company of the proposed disposition and furnishes the Company with a statement of the circumstances surrounding the proposed disposition, and, if requested by the Company, furnishes to the Company an opinion of counsel acceptable to the Company's counsel, that such disposition will not require registration under the Securities Act and will be in compliance with all applicable state securities laws.

Notwithstanding anything else herein to the contrary, neither the Company or any Affiliate has any obligation to register the Ordinary Shares or file any registration statement under either federal or state securities laws, nor does the Company or any Affiliate make any representation concerning the likelihood of a public offering of the Ordinary Shares or any other securities of the Company or any Affiliate.

**7.5.3** Share Legends. All certificates evidencing Ordinary Shares issued or delivered under this Plan shall bear the following legends and/or any other appropriate or required legends under applicable laws:

“OWNERSHIP OF THIS CERTIFICATE, THE SHARES EVIDENCED BY THIS CERTIFICATE AND ANY INTEREST THEREIN ARE SUBJECT TO SUBSTANTIAL RESTRICTIONS ON TRANSFER UNDER APPLICABLE LAW AND UNDER AGREEMENTS WITH THE COMPANY, INCLUDING RESTRICTIONS ON SALE, ASSIGNMENT, TRANSFER, PLEDGE OR OTHER DISPOSITION.”

“THE SHARES ARE SUBJECT TO THE COMPANY’S RIGHT OF FIRST REFUSAL AND CALL RIGHTS TO REPURCHASE THE SHARES UNDER THE COMPANY’S SHARE INCENTIVE PLAN AND AGREEMENTS WITH THE COMPANY THEREUNDER.”

“THE SHARES REPRESENTED BY THIS CERTIFICATE ARE SUBJECT TO A LOCK-UP PERIOD FOLLOWING THE EFFECTIVE DATE OF A REGISTRATION STATEMENT OF THE COMPANY FILED UNDER THE SECURITIES ACT OF 1933, AS AMENDED (“ACT”), AS SET FORTH IN AN AGREEMENT BETWEEN THE COMPANY AND THE ORIGINAL HOLDER OF THESE SHARES, A COPY OF WHICH MAY BE OBTAINED AT THE PRINCIPAL OFFICE OF THE COMPANY. SUCH LOCK-UP PERIOD IS BINDING ON TRANSFEREES OF THESE SHARES.”

“THE SECURITIES REPRESENTED HEREBY HAVE NOT BEEN REGISTERED OR QUALIFIED UNDER THE ACT, NOR HAVE THEY BEEN REGISTERED OR QUALIFIED UNDER THE SECURITIES LAWS OF ANY STATE. NO TRANSFER OF SUCH SECURITIES WILL BE PERMITTED UNLESS A REGISTRATION STATEMENT UNDER THE ACT IS IN EFFECT AS TO SUCH TRANSFER, THE TRANSFER IS MADE IN ACCORDANCE WITH RULE 144 UNDER THE ACT, OR IN THE OPINION OF COUNSEL TO THE COMPANY, REGISTRATION UNDER THE ACT IS UNNECESSARY IN ORDER FOR SUCH TRANSFER TO COMPLY WITH THE ACT AND WITH ANY OTHER APPLICABLE SECURITIES LAWS.”

**7.5.4** Confidential Information. Any financial or other information relating to the Company obtained by Participants in connection with or as a result of this Plan or their Awards shall be treated as confidential.

7.6 **Tax Withholding.** Upon any exercise, vesting, or payment of any Award or upon the disposition of Ordinary Shares acquired pursuant to the exercise of an Incentive Stock Option prior to satisfaction of the holding period requirements of Section 422 of the Code, the Company or any of its Affiliates shall have the right at its option to:

- (a) require the Participant (or the Participant's Personal Representative or Beneficiary, as the case may be) to pay or provide for payment of at least the minimum amount of any taxes which the Company or Affiliate may be required to withhold with respect to such Award event or payment;
- (b) deduct from any amount otherwise payable (in respect of an Award or otherwise) in cash to the Participant (or the Participant's Personal Representative or Beneficiary, as the case may be) the minimum amount of any taxes which the Company or Affiliate may be required to withhold with respect to such Award event or payment; or
- (c) reduce the number of Ordinary Shares to be delivered by (or otherwise reacquire shares held by the Participant) the appropriate number of Ordinary Shares, valued at their then Fair Market Value, to satisfy the minimum withholding obligation.

In any case where a tax is required to be withheld (including taxes in the PRC where applicable) in connection with the delivery of Ordinary Shares under this Plan (including the sale of Ordinary Shares as may be required to comply with foreign exchange rules in the PRC for Participants resident in the PRC), the Administrator may in its sole discretion (subject to Section 7.5) grant (either at the time of the Award or thereafter) to the Participant the right to elect, pursuant to such rules and subject to such conditions as the Administrator may establish, to have the Company reduce the number of shares to be delivered by (or otherwise reacquire) the appropriate number of shares, valued in a consistent manner at their Fair Market Value or at the sales price in accordance with authorized procedures for cashless exercises, necessary to satisfy the minimum applicable withholding obligation on exercise, vesting or payment. In no event shall the shares withheld exceed the minimum whole number of shares required for tax withholding under applicable law. The Company may, with the Administrator's approval, accept one or more promissory notes from any Eligible Person in connection with taxes required to be withheld upon the exercise, vesting or payment of any Award under this Plan; provided that any such note shall be subject to terms and conditions established by the Administrator and the requirements of applicable law. Any such note need not otherwise comply with the provisions of Section 5.3.3.

**7.7 Plan and Award Amendments, Termination and Suspension.**

**7.7.1 Board Authorization.** The Board may, at any time, terminate or, from time to time, amend, modify or suspend this Plan, in whole or in part. No Awards may be granted during any period that the Board suspends this Plan.

**7.7.2 Shareholder Approval.** To the extent then required by applicable law or any applicable listing agency or required under Sections 162, 422 or 424 of the Code or other applicable tax law, rules or regulations, to preserve the intended tax consequences of this Plan, or deemed necessary or advisable by the Board, any amendment to this Plan shall be subject to shareholder approval.

**7.7.3 Amendments to Awards.** Without limiting any other express authority of the Administrator under (but subject to) the express limits of this Plan, the Administrator by agreement or resolution may waive conditions of or limitations on Awards to Participants that the Administrator in the prior exercise of its discretion has imposed, without the consent of a Participant, and (subject to the requirements of Sections 2.2 and 7.7.4) may make other changes to the terms and conditions of Awards.

**7.7.4 Limitations on Amendments to Plan and Awards.** No amendment, suspension or termination of this Plan or amendment of any outstanding Award shall, without written consent of the Participant, affect in any manner materially adverse to the Participant any rights or benefits of the Participant or obligations of the Company under any Award granted under this Plan prior to the effective date of such change. Changes, settlements and other actions contemplated by Section 7.3 shall not be deemed to constitute changes or amendments for purposes of this Section 7.7.

**7.8 Privileges of Share Ownership.** Except as otherwise expressly authorized by the Administrator, a Participant will not be entitled to any privilege of share ownership as to any Ordinary Shares not actually delivered to and held of record by the Participant. Except as expressly required by Section 7.3.1, no adjustment will be made for dividends or other rights as a shareholder for which a record date is prior to such date of delivery.

**7.9 Share-Based Awards in Substitution for Awards Granted by Other Company.** Awards may be granted to Eligible Persons in substitution for or in connection with an assumption of employee share options, share appreciation rights, restricted shares or other share-based awards granted by other entities to persons who are or who will become Eligible Persons in respect of the Company or one of its Affiliates, in connection with a distribution, merger, amalgamation or other reorganization by or with the granting entity or an affiliated entity, or the acquisition by the Company or one of its Affiliates, directly or indirectly, of all or a substantial part of the shares or assets of the employing entity. The Awards so granted need not comply with other specific terms of this Plan, provided the Awards reflect only adjustments giving effect to the assumption or substitution consistent with the conversion applicable to the Ordinary Shares in the transaction and any change in the issuer of the security. Any shares that are delivered and any Awards that are granted by, or become obligations of, the Company, as a result of the assumption by the Company of, or in substitution for, outstanding awards previously granted by an acquired company (or previously granted by a predecessor employer (or direct or indirect parent thereof) in the case of persons that become employed by the Company or one of its Affiliates in connection with a business or asset acquisition or similar transaction) shall not be counted against the Share Limit or other limits on the number of shares available for issuance under this Plan.



**7.10 Effective Date of the Plan.** This Plan is effective upon the Effective Date, subject to approval by the shareholders of the Company within twelve months after the date the Board approves this Plan.

**7.11 Term of the Plan.** Unless earlier terminated by the Board, this Plan will terminate at the close of business on the day before the 10<sup>th</sup> anniversary of the Effective Date. After the termination of this Plan either upon such stated expiration date or its earlier termination by the Board, no additional Awards may be granted under this Plan, but previously granted Awards (and the authority of the Administrator with respect thereto, including the authority to amend such Awards) shall remain outstanding in accordance with their applicable terms and conditions and the terms and conditions of this Plan.

**7.12 Governing Law/Severability/Construction.**

**7.12.1 Choice of Law.** This Plan, the Awards, all documents evidencing Awards and all other related documents will be governed by, and construed in accordance with, the laws of the Cayman Islands.

**7.12.2 Severability.** If it is determined that any provision of this Plan or an Award Agreement is invalid and unenforceable, the remaining provisions of this Plan and/or the Award Agreement, as applicable, will continue in effect provided that the essential economic terms of this Plan and the Award can still be enforced.

**7.12.3 Construction.** It is intended that this Plan, and any Award under this Plan, will be exempt from, or comply with, Sections 409A and 457A of the Code so as to not result in any tax, penalty or interest thereunder, and this Plan and each Award shall be construed and interpreted consistent with that intent.

**7.13 Captions.** Captions and headings are given to the sections and subsections of this Plan solely as a convenience to facilitate reference. Such headings will not be deemed in any way material or relevant to the construction or interpretation of this Plan or any provision thereof.

**7.14 Non-Exclusivity of Plan.** Nothing in this Plan will limit or be deemed to limit the authority of the Board or the Administrator to grant awards or authorize any other compensation, with or without reference to the Ordinary Shares, under any other plan or authority.

**7.15 No Restriction on Corporate Powers.** The existence of this Plan, the Award Agreements, and the Awards granted hereunder, shall not limit, affect or restrict in any way the right or power of the Board or the shareholders of the Company to make or authorize: (a) any adjustment, recapitalization, reorganization or other change in the Company's or any Affiliate's capital structure or its business; (b) any merger, amalgamation, consolidation or change in the ownership of the Company or any Affiliate; (c) any issue of bonds, debentures, capital, preferred or prior preference shares ahead of or affecting the Company's authorized shares or the rights thereof; (d) any dissolution or liquidation of the Company or any Affiliate; (e) any sale or transfer of all or any part of the Company or any Affiliate's assets or business; or (f) any other corporate act or proceeding by the Company or any Affiliate. No Participant, Beneficiary or any other person shall have any claim under any Award or Award Agreement against any member of the Board or the Administrator, or the Company or any employees, officers or agents of the Company or any Affiliate, as a result of any such action.

**7.16 Other Company Compensation or Benefit Programs.** Payments and other benefits received by a Participant under an Award made pursuant to this Plan shall not be deemed a part of a Participant's compensation for purposes of the determination of benefits under any other employee welfare or benefit plans or arrangements, if any, provided by the Company or any Affiliate, except where the Administrator or the Board expressly otherwise provides or authorizes in writing. Awards under this Plan may be made in addition to, in combination with, as alternatives to or in payment of grants, awards or commitments under any other plans or arrangements of the Company or any Affiliate.

**8. DEFINITIONS.**

"**Administrator**" has the meaning given to such term in Section 2.1.

"**Affiliate**" means (a) any corporation (other than the Company) in an unbroken chain of corporations ending with the Company if, at the time of the determination, each of the corporations other than the Company owns stock possessing fifty percent (50%) or more of the total combined voting power of all classes of stock in one of the other corporations in such chain, or (b) any corporation (other than the Company) in an unbroken chain of corporations beginning with the Company if, at the time of the determination, each of the corporations other than the last corporation in the unbroken chain owns stock possessing fifty percent (50%) or more of the total combined voting power of all classes of stock in one of the other corporations in such chain.

"**Award**" means an award of any Option, SAR or Share Award, or any combination thereof, whether alternative or cumulative, authorized by and granted under this Plan.

"**Award Agreement**" means any writing, approved by the Administrator, setting forth the terms of an Award that has been duly authorized and approved.

"**Award Date**" means the date upon which the Administrator took the action granting an Award or such later date as the Administrator designates as the Award Date at the time of the grant of the Award.

"**Beneficiary**" means the person, persons, trust or trusts designated by a Participant, or, in the absence of a designation, entitled by will or the laws of descent and distribution, to receive the benefits specified in the Award Agreement and under this Plan if the Participant dies, and means the Participant's executor or administrator if no other Beneficiary is designated and able to act under the circumstances.

“**Board**” means the Board of Directors of the Company.

“**Cause**” with respect to a Participant means (unless otherwise expressly provided in the applicable Award Agreement, or another applicable contract with the Participant that defines such term for purposes of determining the effect that a “for cause” termination has on the Participant’s Awards) a termination of employment or service based upon a finding by the Company or any of its Affiliates, acting in good faith and based on its reasonable belief at the time, that the Participant:

- (a) has been negligent in the discharge of his or her duties to the Company or any Affiliate, has refused to perform stated or assigned duties or is incompetent in or (other than by reason of a disability or analogous condition) incapable of performing those duties;
- (b) has been dishonest or committed or engaged in an act of theft, embezzlement or fraud, a breach of confidentiality, an unauthorized disclosure or use of inside information, customer lists, trade secrets or other confidential information;
- (c) has breached a fiduciary duty, or willfully and materially violated any other duty, law, rule, regulation or policy of the Company or any of its Affiliates; or has been convicted of, or pled guilty or nolo contendere to, a felony or misdemeanor (other than minor traffic violations or similar offenses);
- (d) has materially breached any of the provisions of any agreement with the Company or any of its Affiliates;
- (e) has engaged in unfair competition with, or otherwise acted intentionally in a manner injurious to the reputation, business or assets of, the Company or any of its Affiliates; or
- (f) has improperly induced a vendor or customer to break or terminate any contract with the Company or any of its Affiliates or induced a principal for whom the Company or any Affiliate acts as agent to terminate such agency relationship.

A termination for Cause shall be deemed to occur (subject to reinstatement upon a contrary final determination by the Administrator) on the date on which the Company or any Affiliate first delivers written notice to the Participant of a finding of termination for Cause.

“**Change in Control Event**” means any of the following:

- (a) Approval by shareholders of the Company (or, if no shareholder approval is required, by the Board alone) of the complete dissolution or liquidation of the Company, other than in the context of a Business Combination that does not constitute a Change in Control Event under paragraph (c) below;
- (b) The acquisition by any individual, entity or group (within the meaning of Section 13(d)(3) or 14(d)(2) of the Exchange Act (a “**Person**”)) of beneficial ownership (within the meaning of Rule 13d-3 promulgated under the Exchange Act) of 50% or more of either (1) the then-outstanding Ordinary Shares of the Company (the “**Outstanding Company Ordinary Shares**”) or (2) the combined voting power of the then-outstanding voting securities of the Company entitled to vote generally in the election of directors (the “**Outstanding Company Voting Securities**”); provided, however, that, for purposes of this paragraph (b), the following acquisitions shall not constitute a Change in Control Event; (A) any acquisition directly from the Company, (B) any acquisition by the Company, (C) any acquisition by any employee benefit plan (or related trust) sponsored or maintained by the Company or any Affiliate or a successor, (D) any acquisition by any entity pursuant to a Business Combination, (E) any acquisition by a Person described in and satisfying the conditions of Rule 13d-1(b) promulgated under the Exchange Act, or (F) any acquisition by a Person who is the beneficial owner (within the meaning of Rule 13d-3 promulgated under the Exchange Act) of 50% or more of the Outstanding Company Ordinary Shares and/or the Outstanding Company Voting Securities on the Effective Date (or an affiliate, heir, descendant, or related party of or to such Person);

- (c) Consummation of a reorganization, amalgamation, merger, statutory share exchange or consolidation or similar corporate transaction involving the Company or any other entity a majority of whose outstanding voting shares or voting power is beneficially owned directly or indirectly by the Company (a “**Subsidiary**”), a sale or other disposition of all or substantially all of the assets of the Company, or the acquisition of assets or shares of another entity by the Company or any of its Subsidiaries (each, a “**Business Combination**”), in each case unless, following such Business Combination, (1) all or substantially all of the individuals and entities that were the beneficial owners of the Outstanding Company Ordinary Shares and the Outstanding Company Voting Securities immediately prior to such Business Combination beneficially own, directly or indirectly, more than 50% of the then-outstanding ordinary or common shares and the combined voting power of the then-outstanding voting securities entitled to vote generally in the election of directors, as the case may be, of the entity resulting from such Business Combination (including, without limitation, an entity that, as a result of such transaction, owns the Company or all or substantially all of the Company’s assets directly or through one or more subsidiaries (a “**Parent**”), and (2) no Person (excluding any individual or entity described in clauses (C), (E) or (F) of paragraph (b) above) beneficially owns (within the meaning of Rule 13d-3 promulgated under the Exchange Act), directly or indirectly, more than 50% of, respectively, the then-outstanding ordinary or common shares of the entity resulting from such Business Combination or the combined voting power of the then-outstanding voting securities of such entity, except to the extent that the ownership in excess of 50% existed prior to the Business Combination;

provided, however, that a transaction shall not constitute a Change in Control Event if it is in connection with the underwritten public offering of the Company’s securities.

“**Code**” means the U.S. Internal Revenue Code of 1986, as amended from time to time.

“**Company**” means BELITE BIO, INC, an exempted company organized under the Companies Law, Cap 22 (Law 3 of 1961, as consolidated and revised) of the Cayman Islands, and its successors.

“**Effective Date**” means the date the Board approved this Plan.

“**Eligible Person**” has the meaning given to such term in Section 3 of this Plan.

“**Exchange Act**” means the U.S. Securities Exchange Act of 1934, as amended from time to time.

“**Fair Market Value**,” for purposes of this Plan and unless otherwise determined or provided by the Administrator in the circumstances, means as follows:

- (a) If the Ordinary Shares are listed or admitted to trade on the New York Stock Exchange or other national securities exchange (the “**Exchange**”), the Fair Market Value shall equal the closing price of an Ordinary Share as reported on the composite tape for securities on the Exchange for the date in question, or, if no sales of Ordinary Shares were made on the Exchange on that date, the closing price of an Ordinary Share as reported on said composite tape for the next preceding day on which sales of Ordinary Shares were made on the Exchange. The Administrator may, however, provide with respect to one or more Awards that the Fair Market Value shall equal the closing price of an Ordinary Share as reported on the composite tape for securities listed on the Exchange on the last trading day preceding the date in question or the average of the high and low trading prices of an Ordinary Share as reported on the composite tape for securities listed on the Exchange for the date in question or the most recent trading day.
- (b) If the Ordinary Shares are not listed or admitted to trade on a national securities exchange, the Fair Market Value shall be the value as reasonably determined by the Administrator for purposes of the Award in the circumstances (with the expectation being that, in the case of a valuation as of a transaction in which Ordinary Shares or similar securities are being sold or exchanged, such determination by the Administrator will be principally based on the value of the consideration received by the holders of the securities sold or exchanged in such transaction).

The Administrator also may adopt a different methodology for determining Fair Market Value with respect to one or more Awards if a different methodology is necessary or advisable to secure any intended favorable tax, legal or other treatment for the particular Award(s) (for example, and without limitation, the Administrator may provide that Fair Market Value for purposes of one or more Awards will be based on an average of closing prices (or the average of high and low daily trading prices) for a specified period preceding the relevant date).

Any determination as to Fair Market Value made pursuant to this Plan shall be made without regard to any restriction other than a restriction which, by its terms, will never lapse, and shall be conclusive and binding on all persons with respect to Awards granted under this Plan.

“**Incentive Stock Option**” means an Option that is designated and intended as an “incentive stock option” within the meaning of Section 422 of the Code, the award of which contains such provisions (including but not limited to the receipt of shareholder approval of this Plan, if the award is made prior to such approval) and is made under such circumstances and to such persons as may be necessary to comply with that section.

“**Nonqualified Option**” means an Option that is not an “incentive stock option” within the meaning of Section 422 of the Code and includes any Option designated or intended as a Nonqualified Option and any Option designated or intended as an Incentive Stock Option that fails to meet the applicable legal requirements thereof.

“**Option**” means an option to purchase Ordinary Shares granted under Section 5 of this Plan. The Administrator will designate any Option granted to an employee of the Company or an Affiliate as a Nonqualified Option or an Incentive Stock Option and may also designate any Option as an Early Exercise Option.

“**Ordinary Shares**” means the Company’s Ordinary Shares, par value US\$0.0001 per share, and such other securities or property as may become the subject of Awards, or become subject to Awards, pursuant to an adjustment made under Section 7.3.1 of this Plan.

“**Participant**” means an Eligible Person who has been granted and holds an Award under this Plan.

“**Personal Representative**” means the person or persons who, upon the disability or incompetence of a Participant, has acquired on behalf of the Participant, by legal proceeding or otherwise, the power to exercise the rights or receive benefits under this Plan by virtue of having become the legal representative of the Participant.

“**Plan**” means this BELITE BIO, INC Share Incentive Plan, as it may hereafter be amended from time to time.

“**Public Offering Date**” means the date the Ordinary Shares are first registered under the Exchange Act and listed or quoted on a recognized national securities exchange.

“**Restricted Shares**” means Ordinary Shares awarded to a Participant under this Plan, subject to payment of such consideration and such conditions on vesting (which may include, among others, the passage of time, specified performance objectives or other factors) and such transfer and other restrictions as are established in or pursuant to this Plan and the related Award Agreement, to the extent such remain unvested and restricted under the terms of the applicable Award Agreement.

“**Restricted Share Award**” means an award of Restricted Shares.

“**SAR**” means a share appreciation right, representing the right, subject to the terms and conditions of the Plan and the applicable Award Agreement, to receive a payment, in cash (subject to compliance with Section 457A of the Code) and/or Ordinary Shares (in each case, as specified in the applicable Award Agreement), equal to the excess of the Fair Market Value of an Ordinary Share on the date the SAR is exercised over the “base price” of the SAR, which base price shall be set forth in the applicable Award Agreement.

“**Securities Act**” means the U.S. Securities Act of 1933, as amended from time to time.

“**Severance Date**” with respect to a particular Participant means, unless otherwise provided in the applicable Award Agreement:

- (a) if the Participant is an Eligible Person under clause (a) of Section 3 and the Participant’s employment by the Company or any of its Affiliates terminates (regardless of the reason), the last day that the Participant is actually employed by the Company or such Affiliate (unless, immediately following such termination of employment, the Participant is a member of the Board or, by express written agreement with the Company or any of its Affiliates, continues to provide other services to the Company or any Affiliate as an Eligible Person under clause (c) of Section 3, in which case the Participant’s Severance Date shall not be the date of such termination of employment but shall be determined in accordance with clause (b) or (c) below, as applicable, in connection with the termination of the Participant’s other services);
- (b) if the Participant is not an Eligible Person under clause (a) of Section 3 but is an Eligible Person under clause (b) thereof, and the Participant ceases to be a member of the Board (regardless of the reason), the last day that the Participant is actually a member of the Board (unless, immediately following such termination, the Participant is an employee of the Company or any of its Affiliates or, by express written agreement with the Company or any of its Affiliates, continues to provide other services to the Company or any Affiliate as an Eligible Person under clause (c) of Section 3, in which case the Participant’s Severance Date shall not be the date of such termination but shall be determined in accordance with clause (a) above or (c) below, as applicable, in connection with the termination of the Participant’s employment or other services);
- (c) if the Participant is not an Eligible Person under clause (a) or clause (b) of Section 3 but is an Eligible Person under clause (c) thereof, and the Participant ceases to provide services to the Company or any of its Affiliates as determined in accordance with Section 7.4.4 (regardless of the reason), the last day that the Participant actually provides services to the Company or such Affiliate as an Eligible Person under clause (c) of Section 3 (unless, immediately following such termination, the Participant is an employee of the Company or any of its Affiliates or is a member of the Board, in which case the Participant’s Severance Date shall not be the date of such termination of services but shall be determined in accordance with clause (a) or (b) above, as applicable, in connection with the termination of the Participant’s employment or membership on the Board).

“**Share Award**” means an award granted under Section 6 of this Plan. A Share Award may include: (a) Restricted Shares, share bonuses, performance shares, share units, phantom shares, dividend equivalents, or similar rights to purchase or acquire Ordinary Shares, whether at a fixed or variable price or ratio related to the Ordinary Shares, upon the passage of time, the occurrence of one or more events, or the satisfaction of performance criteria or other conditions, or any combination thereof; or (b) any similar securities with a value derived from the value of or related to the Ordinary Shares and/or returns thereon.

“**Total Disability**” means a “total and permanent disability” within the meaning of Section 22(e)(3) of the Code and, with respect to Awards other than Incentive Stock Options, such other disabilities, infirmities, afflictions, or conditions as the Administrator may include.

**EMPLOYMENT AGREEMENT**

**THIS EMPLOYMENT AGREEMENT** (the "**Agreement**") is made and entered into on \_\_\_\_\_ by and between Belite Bio, Inc, a Company incorporated in the Cayman Islands (the "**Company**") and, together with all of its direct or indirect parent companies, subsidiaries, affiliates, or subsidiaries or affiliates of its parent companies, collectively referred to as the "**Company Group**"), and [ ], an individual, a [ ] citizen with [his/her] passport number being [ ] (the "**Executive**").

**RECITALS**

**THE PARTIES ENTER THIS AGREEMENT** on the basis of the following facts, understandings and intentions:

**A.** The Company desires that the Executive be employed by the Company to carry out the duties and responsibilities described below, all on the terms and conditions hereinafter set forth.

**B.** The Executive desires to accept such employment on such terms and conditions.

**NOW, THEREFORE**, in consideration of the above recitals incorporated herein and the mutual covenants and promises contained herein and other good and valuable consideration, the receipt and sufficiency of which are hereby expressly acknowledged, the parties agree as follows:

**1. Retention and Duties.**

**1.1 Retention.** The Company does hereby hire, engage and employ the Executive for the Period of Employment (as defined in Section 2) on the terms and conditions expressly set forth in this Agreement. The Executive does hereby accept and agree to such hiring, engagement and employment, on the terms and conditions expressly set forth in this Agreement. The Executive agrees to commence active employment with the Company on or before [Date] (the first day of such employment is referred to as the "**Employment Commencement Date**").

**1.2 Duties.** During the Period of Employment, the Executive shall serve the Company as its [position] and shall have such powers, duties and obligations consistent with such position as the Company shall determine from time to time. The duties of the Executive include, among others, (i) [Duties]; and (ii) [Duties]. The Executive shall be subject to such directives of the Board and comply with the corporate policies of the Company and the Company Group as they are in effect from time to time throughout the Period of Employment (including, without limitation, the Company's business conduct and ethics policies, as amended from time to time). During the Period of Employment, the Executive shall report to [the Chairman/CEO and/or the Board of the Company]/[the Board of the Company].



- 1.3 **No Other Employment; Minimum Time Commitment.** During the Period of Employment, the Executive shall (i) devote substantially all of the Executive's business time, energy and skill to the performance of the Executive's duties for the Company and Company Group, and (ii) hold no other employment, except for (in the case of (i)) or by (in the case of (ii)) one or more other companies in the Company Group or, in each case of (i) and (ii), as instructed or otherwise permitted by the Company in writing. The Executive's service on the boards of directors (or similar body) of business entities other than the Company Group is subject to the approval of the Board [of the Company]. The Company shall have the right to require the Executive to resign from any board [of directors] or similar body which he may then serve if the Board [of the Company] reasonably determines in writing that the Executive's service on such board or body interferes with the effective discharge of the Executive's duties and responsibilities to the Company or that any business related to such service is then in competition with any business of the Company or any of its affiliates, successors or assigns.
- 1.4 **No Breach of Contract.** The Executive hereby represents to the Company that: (i) the execution and delivery of this Agreement by the Executive and the Company and the performance by the Executive of the Executive's duties hereunder shall not constitute a breach of, or otherwise contravene, the terms of any other agreement or policy to which the Executive is a party or otherwise bound; (ii) that the Executive has no information (including, without limitation, confidential information and trade secrets) relating to any other person or entity which would prevent, or be violated by, the Executive entering into this Agreement or carrying out his duties hereunder; (iii) that the Executive is not bound by any confidentiality, trade secret or similar agreement (other than this Agreement) with any other person or entity.
2. **Period of Employment.** The "Period of Employment" shall be the period commencing on the Employment Commencement Date and ending at the close of business on the date this Agreement is terminated by the Executive or the Company. [The Executive's employment with the Company is "at will." Either the Executive or the Company is entitled to terminate the employment at any time for any reason, with or without cause and with 3-monthnotice, without liability.]
3. **Compensation.**
- 3.1 **Base Salary and Bonus.** The Executive's base salary (the "Base Salary") during the Period of Employment shall be [determined by the Company as specified in a separate agreement between the Executive and the Company's designated subsidiary or affiliate (the "Subsidiary Employment Agreement"). During the Period of Employment, the Executive shall be eligible to receive a bonus as determined in the Subsidiary Employment Agreement.] / [paid in accordance with the Company's regular payroll practices in effect from time to time, but not less frequently than in monthly installments. The Executive's Base Salary of the Period of Employment shall be at an annualized rate of US\$ [.]. During the Period of Employment, the Executive will be eligible to a base bonus of 10% of his/her annual base salary by year end based on the number of month that the Executive works at the Company in that year. Performance Bonuses [within 5%-10% of his/her annual base salary] will be payable against milestones discussed and agreed between the Executive and the Chairman/CEO and/or the Board of the Company. Except as otherwise expressly provided in this Agreement, the Executive must be employed by the Company through the last day of the period to which a Bonus relates in order to be eligible for a Bonus (or portion thereof) with respect to that period (and, if the Executive is not so employed at such time, in no event shall he have been considered to have "earned" any Bonus with respect to such period). Any Bonus will be paid, subject to applicable tax withholding, as soon as practicable after the end of the period to which such bonus relates. The Company will review the Executive's Base Salary and Bonuses at least annually.]

3.2 **Intentionally Left Blank**

3.3 **Intentionally Left Blank**

3.4 **Intentionally Left Blank**

4. **Benefits.**

4.1 **Retirement, Welfare and Fringe Benefits.** During the Period of Employment, the Executive shall be entitled to participate in all employee pension and welfare benefit plans and programs, and fringe benefit plans and programs if made available by the Company to the Company's employees generally, in accordance with the eligibility and participation provisions of such plans and as such plans or programs may be in effect from time to time. [The Company will reimburse 100% of the insurance premiums of the Executive and the dependents of the Executive.] / [The Company will, pursuant to the relevant requirements under applicable laws and regulations, make necessary arrangements for the Executive to participate in the labor insurance program, the national health insurance program, and any other statutory insurance program.]

4.2 **Reimbursement of Business Expenses.** The Executive is authorized to incur reasonable expenses in carrying out the Executive's duties for the Company under this Agreement and reimbursement for all reasonable business expenses the Executive incurs during the Period of Employment in connection with carrying out the Executive's duties for the Company, subject to the Company's expense reimbursement policies in effect from time to time.

4.3 **Vacation and Other Leave.** During the Period of Employment, the Executive shall accrue and be entitled to take paid vacation days in accordance with the Company's vacation policies in effect from time to time, including the Company's policies regarding vacation accruals; provided that the Executive's rate of vacation accrual during the Period of Employment shall be no less than the number of days per year as determined in the Subsidiary Employment Agreement. The Executive shall also be entitled to all other holiday and leave pay generally available to other executives of the Company. The Executive may choose to cash out unused annual leave entitlements per year at the year end at the rate of his base salary by submitting an annual leave cash out agreement or accrue the unused annual leave entitlements to the following year. Any accrued but unused and unpaid annual leave will be paid out at termination of employment at the rate of his base salary upon termination.

5. **Termination.** [This Agreement may be terminated at any time by mutual agreement of the parties hereto. This Agreement may also be terminated by either party pursuant to the relevant provisions of applicable law.]

5.1 **Termination at will.** The Executive's employment by the Company, and the Period of Employment, may be terminated at any time by the Company or by the Executive [with 3-month notice]. / [Intentionally Left Blank]

5.2 **Benefits Upon Termination.** If the Executive's employment by the Company is terminated for any reason, upon the date that the Executive's employment by the Company terminates (the "Severance Date"), [the Company shall have no further obligation to make or provide to the Executive, and the Executive shall have no further right to receive or obtain from the Company, any payments or benefits except as follows] / [in addition to any statutory severance payment to which the Executive is entitled]:

(a) The Company shall pay the Executive (or, in the event of [his/her] death, the Executive's estate) any Accrued Obligations (as defined in Section 5.4); and

(b) [Subject to applicable laws, if/If] a Change of Control (as defined in Section 5.4) occurs any time during the Period of Employment and on or within six months following such Change of Control, the Executive's employment with the Company terminates as a result of an Involuntary Termination (as defined in Section 5.4), the Executive shall be entitled to [(i) a severance payment in the amount equals to the then applicable Base Salary rate of the Executive for a six-month period, such amount to be paid to the Executive in the month following the month in which the Executive's Separation from Service occurs; and (ii) the accelerated vesting of any then-outstanding and unvested portion of the grants of the Company's stock options granted to the Executive so that such outstanding stock options shall become vested in full as of the Severance Date.

(c) Notwithstanding the foregoing provisions of this Section 5.2, if the Executive breaches [his/her] obligations under Section 6 of this Agreement at any time, from and after the date of such breach and not in any way in limitation of any right or remedy otherwise available to the Company, the Executive will no longer be entitled to, and the Company will no longer be obligated to pay, any remaining unpaid severance amount contemplated by Section 5.2[; provided that, if the Executive provides the release contemplated by Section 5.3, in no event shall the Executive be entitled to benefits pursuant to Section 5.2(b) of less than US\$5,000 (or the amount of such benefits, if less than US\$5,000), which amount the parties agree is good and adequate consideration, in and of itself, for the Executive's release contemplated by Section 5.3].

(d) The foregoing provisions of this Section 5.2 shall not affect: [(i) the Executive's receipt of benefits otherwise due to terminated employees under group insurance coverage consistent with the terms of the applicable Company welfare benefit plan; (ii) the Executive's rights under COBRA to continue health coverage; or (iii) the Executive's receipt of benefits otherwise due in accordance with the terms of the Company's 401(k) plan (if any).] / [the Executive's receipt of benefits otherwise due to terminated employees under insurance coverage consistent with the terms of the applicable Company labor insurance program, national health insurance program, or any other statutory insurance program.]

**5.3 Release; Exclusive Remedy.**

(a) This Section 5.3 shall apply notwithstanding anything else contained in this Agreement or any stock option or other equity-based award agreement to the contrary. As a condition precedent to any Company obligation to the Executive pursuant to Section 5.2(b) or any other obligation to accelerate vesting of any equity-based award in connection with the termination of the Executive's employment, the Executive shall, upon or promptly following [his/her] last day of employment with the Company (and in all events within twenty-one (21) days after [his/her] last day of employment with the Company), execute and deliver to the Company a valid general release of claims (the "General Release") in a form acceptable to the Board and such release agreement shall have not been revoked by the Executive pursuant to any revocation rights afforded by applicable law.

(b) The Executive agrees that [in addition to any statutory severance payment to which the Executive is entitled,] the payments contemplated by Section 5.2 (and any applicable acceleration of vesting of an equity-based award in accordance with the terms of such award in connection with the termination of the Executive's employment) shall constitute the exclusive and sole remedy for any termination of [his/her] employment and the Executive covenants not to assert or pursue any other remedies, at law or in equity, with respect to any termination of employment. The Company and Executive acknowledge and agree that there is no duty of the Executive to mitigate damages under this Agreement. All amounts paid to the Executive pursuant to Section 5.2 shall be paid without regard to whether the Executive has taken or takes actions to mitigate damages.

**5.4 Certain Defined Terms.**

(a) As used herein, "Accrued Obligations" means:

- (i) any Base Salary that had accrued but had not been paid (including accrued and unpaid vacation time) on or before the Severance Date; and
- (ii) any reimbursement due to the Executive pursuant to Section 4.2 for expenses incurred by the Executive on or before the Severance Date.

(b) As used herein, "Cause" shall mean, as reasonably determined by the Board of the Company (excluding the Executive, if he is then a member of the Board of the Company), (i) any act of personal dishonesty taken by the Executive in connection with [his/her] responsibilities as an employee of the Company which is intended to result in substantial personal enrichment of the Executive and is reasonably likely to result in material harm to the Company, (ii) the Executive's conviction of a crime which the Board of the Company reasonably believes has had or will have a material detrimental effect on the Company's reputation or business, (iii) a willful act by the Executive which constitutes misconduct and is materially injurious to the Company, or (iv) continued violations by the Executive of the Executive's obligations to the Company after there has been delivered to the Executive a written demand for performance from the Company which describes the basis for the Company's belief that the Executive has violated [his/her] obligations to the Company.

(c) As used herein, "Change of Control" shall mean (x) a merger, amalgamation or consolidation of the Company or Parent, in one or a series of related transactions, as a result of which the shareholders of the Company or Parent, as applicable, do not control fifty percent (50%) or more of the total voting power of the surviving entity (other than a transaction, the sole purpose of which is to effect the reincorporation of the Company or Parent in a different jurisdiction), or (y) the sale, transfer or other disposition of all or substantially all of the Company or Parent's assets in one or a series of related transactions in liquidation or dissolution of the Company or Parent .

(d) As used herein, "Constructive Termination" shall mean a resignation by the Executive within thirty (30) days after the occurrence of any of the following [events, subject to applicable law] (in each case, without the Executive's prior written consent): (i) a material reduction of the Executive's duties, authority or responsibilities relative to the Executive's duties, position or responsibilities in effect immediately prior to such reduction; (ii) a material reduction by the Company of the Executive's Base Salary as in effect immediately prior to such reduction; or (iii) the relocation of the Executive's principal place of employment with the Company to a facility or a location more than fifty (50) miles from [his/her] current location; provided, however, that any such condition or conditions, as applicable, shall not constitute grounds for Constructive Termination unless both (x) the Executive provides written notice to the Company of the condition claimed to constitute grounds for Constructive Termination within thirty (30) days of the initial existence of such condition(s) (such notice to be delivered in accordance with Section 17), and (y) the Company fails to remedy such condition(s) within thirty (30) days of receiving such written notice thereof; and provided, further, that in all events the termination of the Executive's employment with the Company shall not constitute a Constructive Termination unless such termination occurs not more than ninety (90) days following the initial existence of the condition claimed to constitute grounds for Constructive Termination.

(e) As used herein, "Disability" shall mean a physical or mental impairment which, as reasonably determined by the Board of the Company, renders the Executive unable to perform the essential functions of [his/her] employment with the Company, even with reasonable accommodation that does not impose an undue hardship on the Company, for more than 180 days in any 12-month period, unless a longer period is required by applicable law, in which case that longer period would apply.

(f) As used herein, "Involuntary Termination" shall mean a Constructive Termination or a termination of the Executive by the Company without Cause. For purposes of clarity, the term Involuntary Termination does not include a termination of the Executive's employment due to the Executive's death or Disability.

(g) [As used herein, a "Separation from Service" occurs when the Executive dies, retires, or otherwise has a termination of employment with the Company that constitutes a "separation from service" within the meaning of Treasury Regulation Section 1.409A-1(h)(1), without regard to the optional alternative definitions available thereunder.] / [Intentionally Left Blank]

**6. Confidentiality; Inventions; Non-Solicitation.**

**6.1 Confidential Information.**

(a) Company Information. The Executive hereby agrees that at all times during the Period of Employment and thereafter, to hold in strictest confidence, and not to use, except for the benefit of the Company Group, or to disclose to any person, firm or corporation without written authorization of an officer of the Company Group (other than the Executive), any Confidential Information, except under a non-disclosure agreement duly authorized and executed by the Company. The Executive understands that "Confidential Information" means any non-public information of the Company that relates to its actual or anticipated business or research and development, or to its technical data, trade secrets or know-how. "Confidential Information" includes, without limitation, research, product plans or other information regarding products or services and markets therefor, developments, inventions, processes, formulas, designs, drawings, technology, research and clinical data, chemical structures and formulations, software, protocols, algorithms, engineering, hardware configuration information, customer lists and customers (including, but not limited to, customers of the Company on whom the Executive called or with whom the Executive became acquainted during the Period of Employment), marketing, finances or other business information of the Company. The Executive further understands that Confidential Information does not include any of the foregoing items that have become publicly known and made generally available through no wrongful act (or failure to act) of the Executive or of others who were under confidentiality obligations as to the item or items involved or improvements or new versions thereof. The Executive acknowledges that, as between he and the Company, all Confidential Information shall be the sole and exclusive property of the Company and its assigns.

(b) Company Property. The Executive understands that all documents (including computer records, facsimile and e-mail) and materials created, received or transmitted in connection with [his/her] work or using the facilities of the Company Group are property of the Company Group and subject to inspection by the Company Group, at any time. Upon termination of the Executive's employment with the Company (or at any other time when requested by the Company), the Executive will promptly deliver to the Company all documents and materials of any nature pertaining to [his/her] work with the Company and will provide written certification of [his/her] compliance with this Agreement. Under no circumstances will the Executive have, following [his/her] termination, in [his/her] possession any property of the Company Group, or any documents or materials or copies thereof containing any Confidential Information. In the event of the termination of the Executive's employment, the Executive hereby agrees to sign and deliver the "Termination Certification" attached hereto as Exhibit B.

(c) Former Employer Information. The Executive hereby agrees that [he/she] will not, during the Period of Employment, improperly use or disclose any proprietary information (including, but not limited to, software, source and object code, developments, techniques, inventions, processes, technology, designs and drawings) or trade secrets of any former or concurrent employer or other person or entity and that [he/she] will not bring onto the premises of the Company Group any unpublished document or proprietary information belonging to any such employer, person or entity unless consented to in writing by such employer, person or entity and by an officer of the Company (other than the Executive). The Executive hereby agrees to indemnify the Company Group and hold it harmless from all claims, liabilities, damages and expenses, including reasonable attorneys' fees and costs for resolving disputes, arising out of or in connection with any violation or claimed violation of a third party's rights resulting from any use by the Company Group of such proprietary information or trade secrets improperly used or disclosed by the Executive.

(d) Third Party Information. The Executive recognizes that the Company Group has received and in the future will receive from third parties their confidential or proprietary information subject to a duty on the Company Group's part to maintain the confidentiality of such information and to use it only for certain limited purposes. The Executive hereby agrees to hold all such confidential or proprietary information in the strictest confidence and not to disclose it to any person, firm or corporation or to use it except as necessary in carrying out [his/her] work for the Company consistent with the Company Group's agreement with such third party.

## 6.2 Inventions

(a) Inventions Retained and Licensed. The Executive has attached hereto, as Exhibit C, a list describing all inventions, original works of authorship, developments, improvements, trade secrets, and IC layout designs/mask works which were made by the Executive prior to [his/her] employment with the Company which belong to the Executive, which relate to the Company Group's proposed or current business, products or research and development, and which are not assigned to any member of the Company Group hereunder (collectively referred to as "Prior Inventions"); or, if no such list is attached, The Executive hereby represents that there are no such Prior Inventions. The Executive hereby agrees that he or she will not incorporate any Prior Inventions into any products, processes or machines of the Company Group; provided, however, that if in the course of the Executive's employment with the Company, he or she incorporates into a product, process or machine of the Company Group a Prior Invention owned by the Executive or in which he or she has an interest, the Executive hereby represents that he or she has all necessary rights, powers and authorization to use such Prior Invention in the manner it is used and such use will not infringe any right of any company, entity or person and, in such a circumstance, each member of the Company Group is hereby granted and shall have a nonexclusive, royalty-free, sublicensable, transferable, irrevocable, perpetual, worldwide license to make, have made, modify, use and sell such Prior Invention as part of or in connection with such product, process or machine. The Executive hereby agrees to indemnify the Company Group and hold it harmless from all claims, liabilities, damages and expenses, including reasonable attorneys' fees and costs for resolving disputes, arising out of or in connection with any violation or claimed violation of a third party's rights resulting from any use, sublicensing, modification, transfer, or sale by the Company Group of such Prior Invention.

(b) Assignment of Inventions. The Executive hereby agrees that he or she will promptly make full written disclosure to the Company and the Company Group, will hold in trust for the sole right and benefit of the Company and the Company Group, and hereby assign to the Company and the Company Group, or their respective designee, all of [his/her] right, title, and interest in and to any and all inventions, ideas, information, designs, original works of authorship, processes, formulas, computer software programs, databases, mask works, developments, concepts, improvements or trade secrets, whether or not patentable or registrable under patent, copyright, circuit layout design or similar laws or anywhere else in the world, which he or she may solely or jointly conceive or develop or reduce to practice or cause to be conceived or developed or reduced to practice, during the Period of Employment (whether or not during business hours) that are either related to the scope of [his/her] employment with the Company or make use, in any manner, of the resources of the Company Group (collectively referred to as "Inventions"). The Executive hereby acknowledges that the Company or the Company Group shall be the sole owner of all rights, title and interest in the Inventions created hereunder. In the event the foregoing assignment of Inventions to the Company or the Company Group is ineffective for any reason, each member of the Company Group is hereby granted and shall have a [exclusive] royalty-free, sublicensable, transferable, irrevocable, perpetual, worldwide license to make, have made, modify, use, and sell such Inventions as part of or in connection with any product, process or machine. Such exclusive license shall continue in effect for the maximum term as may now or hereafter be permissible under applicable law. Upon expiration, such license, without further consent or action on the Executive's part, shall automatically be renewed for the maximum term as is then permissible under applicable law, unless, within the six-month period prior to such expiration, the Company and the Executive have agreed that such license will not be renewed. The Executive also hereby forever waives and agrees never to assert any and all rights he or she may have in or with respect to any Inventions even after termination of [his/her] employment with the Company. The Executive hereby further acknowledges that all Inventions created by him or her (solely or jointly with others) are, to the extent permitted by applicable law, "works made for hire" or "inventions made for hire," as those terms are defined in the applicable laws and regulations], respectively in the relevant jurisdiction, and all titles, rights and interests in or to such Inventions are or shall be vested in the Company.

(c) Maintenance of Records. The Executive hereby agrees to keep and maintain adequate and current written records of all Inventions. The records will be in the form of notes, sketches, drawings, and any other format that may be specified by the Company. The records will be available to and remain the sole property of the Company at all times.



(d) **Patent and Copyright Registrations.** The Executive hereby agrees to assist the Company, or its respective designees, at the expense of the Company, in every proper way to secure the Company's rights in the Inventions in any and all countries, to further evidence, record and perfect any grant or assignment by the Executive of the Inventions hereunder and to perfect, obtain, maintain, enforce and defend any rights so granted or assigned, including the disclosure to the Company of all pertinent information and data with respect thereto, the execution of all applications, specifications, oaths, assignments and all other instruments which the Company shall deem necessary in order to apply for and obtain such rights and in order to assign and convey to the Company, its successors, assigns and nominees the sole and exclusive rights, title and interest in and to such Inventions. The Executive hereby further agrees that [his/her] obligations to execute or cause to be executed, when it is in [his/her] power to do so, any such instrument or papers shall continue after the termination of this Agreement. The Executive hereby irrevocably designates and appoints the Company and its duly authorized officers and agents as the Executive's agent and attorney in fact, to act for and in the Executive's behalf and stead to execute and file any such documents and to do all other lawfully permitted acts to further the foregoing with the same legal force and effect as if executed by the Executive.

- 6.3 **Conflicting Employment.** The Executive hereby agrees that, during Period of Employment, he or she will not engage in any other employment, occupation, consulting or other business activity related to the business in which the Company Group is now involved or becomes involved during Period of Employment, nor will the Executive engage in any other activities that conflict with [his/her] obligations to the Company except by, for or on behalf of one or more other companies within the Company Group, or as instructed or otherwise permitted by the Company with a prior written consent.
- 6.4 **Notification of New Employer.** In the event that the Executive leaves the employment of the Company, the Executive hereby grants consent to notification by the Company to [his/her] new employer about [his/her] rights and obligations under this Agreement.
- 6.5 **Non-Solicitation of Employees.** The Executive hereby agrees that, during the Period of Employment and for a period of one (1) year immediately following the termination of [his/her] relationship with the Company for any reason, whether with or without cause, he or she shall not either directly or indirectly solicit, induce, recruit or encourage any employees of the Company Group to leave their employment, or attempt to solicit, induce, recruit, or encourage employees of the Company Group to leave their employment
- 6.6 **Non-Interference with Customers.** The Executive hereby agrees that, during the Period of Employment and [for a period of one (1) year immediately following the termination of [his/her] relationship with the Company for any reason, whether with or without cause, the Executive] / [thereafter, he/she] will not, directly or indirectly through any other person, use any of the Company Group's trade secrets to influence or attempt to influence customers, vendors, suppliers, licensors, lessors, joint venturers, associates, consultants, agents, or partners of any entity within the Company Group to divert their business away from such entity, and the Executive will not otherwise use the Company Group's trade secrets to interfere with, disrupt or attempt to disrupt the business relationships, contractual or otherwise, between any entity within the Company Group, on the one hand, and any of its or their customers, suppliers, vendors, lessors, licensors, joint venturers, associates, officers, employees, consultants, managers, partners, members or investors, on the other hand.

- 6.7 **Understanding of Covenants.** The Executive acknowledges that, in the course of [his/her] employment with the Company Group members and their predecessors, he has become familiar, or will become familiar, with the Company Group members' and their predecessors' trade secrets and with other confidential and proprietary information concerning the Company Group members and their respective predecessors and that [his/her] services have been and will be of special, unique and extraordinary value to the Company Group. The Executive agrees that the foregoing covenants set forth in this Section 6 (together, the "**Restrictive Covenants**") are reasonable and necessary to protect the Company Group's trade secrets and other confidential and proprietary information, good will, stable workforce, and customer relations.
- 6.8 **Enforcement.** The Executive agrees that the Executive's services are unique and that he has access to Confidential Information. Accordingly, the Executive agrees that a breach by the Executive of any of the covenants in this Section 6 would cause immediate and irreparable harm to the Company that would be difficult or impossible to measure, and that damages to the Company for any such injury would therefore be an inadequate remedy for any such breach. Therefore, the Executive agrees that in the event of any breach or threatened breach of any provision of this Section 6, the Company shall be entitled, in addition to and without limitation upon all other remedies the Company may have under this Agreement, at law or otherwise, to obtain specific performance, injunctive relief and/or other appropriate relief (without posting any bond or deposit) in order to enforce or prevent any violations of the provisions of this Section 6, or require the Executive to account for and pay over to the Company all compensation, profits, moneys, accruals, increments or other benefits derived from or received as a result of any transactions constituting a breach of this Section 6 if and when final judgment of a court of competent jurisdiction [or arbitrator], as applicable, is so entered against the Executive. The Executive further agrees that the applicable period of time any Restrictive Covenant is in effect following the Severance Date, as determined pursuant to the foregoing provisions of this Section 6, such period of time shall be extended by the same amount of time that Executive is in breach of any Restrictive Covenant.
7. **Withholding Taxes.** Notwithstanding anything else herein to the contrary, the Company may withhold (or cause there to be withheld, as the case may be) from any amounts otherwise due or payable under or pursuant to this Agreement such national, provincial, local or any other income, employment, or other taxes as may be required to be withheld pursuant to any applicable law or regulation.
8. **Assignment.** This Agreement is personal in its nature and neither of the parties hereto shall, without the consent of the other, assign or transfer this Agreement or any rights or obligations hereunder; provided, however, that in the event of a merger, consolidation, or transfer or sale of all or substantially all of the assets of the Company with or to any other individual(s) or entity, this Agreement shall, subject to the provisions hereof, be binding upon and inure to the benefit of such successor and such successor shall discharge and perform all the promises, covenants, duties, and obligations of the Company hereunder.

9. **Number and Gender.** Where the context requires, the singular shall include the plural, the plural shall include the singular, and any gender shall include all other genders.
10. **Section Headings.** The section headings of, and titles of paragraphs and subparagraphs contained in, this Agreement are for the purpose of convenience only, and they neither form a part of this Agreement nor are they to be used in the construction or interpretation thereof.
11. **Governing Law; Venue.** This Agreement shall be governed by and construed in accordance with the laws of [the State of California] without giving effect to any choice or conflict of law provision or rule that would cause the application of the laws of any jurisdiction other than [the State of California]. [Any dispute arising out of or relating to this Agreement shall be exclusively referred to [ ].]
12. **Severability.** If any provision of this Agreement or the application thereof is held invalid, the invalidity shall not affect other provisions or applications of this Agreement which can be given effect without the invalid provisions or applications and to this end the provisions of this Agreement are declared to be severable.
13. **Entire Agreement.** This Agreement, including the documents referred to herein, embodies the entire agreement of the parties hereto respecting the matters within its scope. This Agreement supersedes all prior and contemporaneous agreements of the parties hereto that directly or indirectly bears upon the subject matter hereof (including, without limitation, any offer letter or previous employment agreement). Any prior negotiations, correspondence, agreements, proposals or understandings relating to the subject matter hereof shall be deemed to have been merged into this Agreement, and to the extent inconsistent herewith, such negotiations, correspondence, agreements, proposals, or understandings shall be deemed to be of no force or effect. There are no representations, warranties, or agreements, whether express or implied, or oral or written, with respect to the subject matter hereof, except as expressly set forth herein.
14. **Modifications.** This Agreement may not be amended, modified or changed (in whole or in part), except by a formal, definitive written agreement expressly referring to this Agreement, which agreement is executed by both of the parties hereto.
15. **Waiver.** Neither the failure nor any delay on the part of a party to exercise any right, remedy, power or privilege under this Agreement shall operate as a waiver thereof, nor shall any single or partial exercise of any right, remedy, power or privilege preclude any other or further exercise of the same or of any right, remedy, power or privilege, nor shall any waiver of any right, remedy, power or privilege with respect to any occurrence be construed as a waiver of such right, remedy, power or privilege with respect to any other occurrence. No waiver shall be effective unless it is in writing and is signed by the party asserted to have granted such waiver.

16. **[Arbitration; Waiver of Jury Trial]**. The Executive and the Company agree that any controversy arising out of or relating to this Agreement, its enforcement or interpretation, or because of an alleged breach, default, or misrepresentation in connection with any of its provisions, or any other controversy arising out of the Executive's employment shall be submitted to arbitration in the United States, before a sole arbitrator (the "Arbitrator") as the exclusive forum for the resolution of such dispute; provided, however, that provisional injunctive relief may, but need not, be sought by either party to this Agreement in a court of law while arbitration proceedings are pending, and any provisional injunctive relief granted by such court shall remain effective until the matter is finally determined by the Arbitrator. Final resolution of any dispute through arbitration may include any remedy or relief which the Arbitrator deems just and equitable, including any and all remedies provided by applicable statutes. At the conclusion of the arbitration, the Arbitrator shall issue a written decision that sets forth the essential findings and conclusions upon which the Arbitrator's award or decision is based. Any award or relief granted by the Arbitrator hereunder shall be final and binding on the parties hereto and may be enforced by any court of competent jurisdiction. The parties acknowledge and agree that they are hereby waiving any rights to trial by jury in any action, proceeding or counterclaim brought by either of the parties against the other in connection with any matter whatsoever arising out of or in any way connected with this Agreement or the Executive's employment. The parties agree that each party shall pay its own attorneys' fees and other expenses.] / **[Intentionally Left Blank]**

17. **Notices.**

(a) All notices, requests, demands and other communications required or permitted under this Agreement shall be in writing and shall be deemed to have been duly given and made if (i) delivered by hand, (ii) otherwise delivered against receipt therefor, or (iii) sent by internationally recognized courier with next-day or second-day delivery. Any notice shall be duly addressed to the parties as follows:

(i) if to the Company:

Address:  
Attention:  
Email:

(ii) if to the Executive:

Email:  
[Attention:]

(b) Any party may alter the address to which communications or copies are to be sent by giving notice of such change of address in conformity with the provisions of this Section 17 for the giving of notice. Any communication shall be effective when delivered by hand, when otherwise delivered against receipt therefor, or three (3) business days after being sent in accordance with the foregoing.

18. **Counterparts.** This Agreement may be executed in any number of counterparts, each of which shall be deemed an original as against any party whose signature appears thereon, and all of which together shall constitute one and the same instrument. This Agreement shall become binding when one or more counterparts hereof, individually or taken together, shall bear the signatures of all of the parties reflected hereon as the signatories. Photographic copies of such signed counterparts may be used in lieu of the originals for any purpose.
19. **Legal Counsel; Mutual Drafting.** Each party recognizes that this is a legally binding contract and acknowledges and agrees that they have had the opportunity to consult with legal counsel of their choice. Each party has cooperated in the drafting, negotiation and preparation of this Agreement. Hence, in any construction to be made of this Agreement, the same shall not be construed against either party on the basis of that party being the drafter of such language. The Executive agrees and acknowledges that he has read and understands this Agreement, is entering into it freely and voluntarily, and has been advised to seek counsel prior to entering into this Agreement and has had ample opportunity to do so.
20. **Intentionally Left Blank**

*[The remainder of this page has intentionally been left blank.]*

IN WITNESS WHEREOF, the Company and the Executive have executed this Agreement as of date first written above.

**“Belite Bio, Inc”**

By: \_\_\_\_\_  
Name: Tom Lin  
Title: Director

IN WITNESS WHEREOF, the Company and the Executive have executed this Agreement as of the date first written above.

**“EXECUTIVE”**

\_\_\_\_\_  
Name:

EXHIBIT A

Intentionally Left Blank



**EXHIBIT B**

**TERMINATION CERTIFICATE**

This is to certify that I do not have in my possession, nor have I failed to return, any Confidential Information belonging to Belite Bio, Inc (the "Company"), its subsidiaries, parent companies, affiliates, successors or assigns (together, the "Company Group"). For purposes of this Termination Certificate, the term "Confidential Information" shall have the meaning assigned thereto in my Employment Agreement with the Company, dated on or about \_\_\_\_\_ (the "**Agreement**").

I further certify that I have complied with all the terms of the Agreement signed by me, including all of the provisions of Section 6 of the Agreement.

I further agree that, in compliance with the Agreement, I will preserve as confidential all Confidential Information.

I further agree that for one (1) year from this date, I will not either directly or indirectly solicit, induce, recruit or encourage any employees of the Company or the Company Group to leave their employment, or take away such employees, or attempt to solicit, induce, recruit, encourage or take away employees of the Company or the Company Group and/or any suppliers, customers or consultants of the Company or the Company Group, either for myself or for any other person or entity.

Date: \_\_\_\_\_

\_\_\_\_\_  
*Signature*

\_\_\_\_\_  
*Print Name*

**EXHIBIT C**

**LIST OF PRIOR INVENTIONS**

Title

Date

Identifying Number  
or Brief Description

\_\_\_\_\_ No inventions or improvements

\_\_\_\_\_ Additional Sheets Attached

Signature of Employee: \_\_\_\_\_

Print Name of Employee: \_\_\_\_\_

Date: \_\_\_\_\_

## INDEMNIFICATION AGREEMENT

THIS INDEMNIFICATION AGREEMENT (this "*Agreement*") is made as of \_\_\_\_\_, by and between Belite Bio, Inc, an exempted company with limited liability duly incorporated and validly existing under the laws of the Cayman Islands (the "*Company*"), and \_\_\_\_\_ (Passport/ID Number \_\_\_\_\_) (the "*Indemnitee*"), a [director/an executive officer] of the Company.

WHEREAS, the Indemnitee has served or has agreed to serve as a director/an executive officer of the Company and in such capacity will render valuable services to the Company; and

WHEREAS, in order to induce and encourage highly experienced and capable persons such as the Indemnitee to serve as directors/an executive officer of the Company, the Board of Directors has determined that this Agreement is not only reasonable and prudent, but necessary to promote and ensure the best interests of the Company and its shareholders;

NOW, THEREFORE, in consideration of the premises and mutual agreements hereinafter set forth, and other good and valuable consideration, including, without limitation, the service of the Indemnitee, the receipt of which hereby is acknowledged, and in order to induce the Indemnitee to serve as a director/an executive officer of the Company, the Company and the Indemnitee hereby agree as follows:

1. **Definitions.** As used in this Agreement:

(a) "**Board of Directors**" shall mean the board of directors of the Company.

(b) "**Change in Control**" shall mean a change in control of the Company of a nature that would be required to be reported in response to Item 6(e) of Schedule 14A of Regulation 14A (or in response to any similar item on any similar or successor schedule or form) promulgated under the United States Securities Exchange Act of 1934, as amended, and the rules and regulations promulgated thereunder (collectively, the "**Act**"), whether or not the Company is then subject to such reporting requirement; provided, however, that, without limitation, such a Change in Control shall be deemed to have occurred (irrespective of the applicability of the initial clause of this definition) if (i) any "person" (as such term is used in Sections 13(d) and 14(d) of the Act, but excluding any trustee or other fiduciary holding securities pursuant to an employee benefit or welfare plan or employee share plan of the Company or any subsidiary of the Company, or any entity organized, appointed, established or holding securities of the Company with voting power for or pursuant to the terms of any such plan) is or becomes the "beneficial owner" (as defined in Rule 13d-3 under the Act), directly or indirectly, of securities of the Company representing 20% or more of the combined voting power of the Company's then outstanding securities without the prior approval of at least two-thirds of the Continuing Directors (as defined below) in office immediately prior to such person's attaining such interest; (ii) the Company is a party to a merger, consolidation, scheme of arrangement, sale of assets or other reorganization, or a proxy contest, as a consequence of which Continuing Directors in office immediately prior to such transaction or event constitute less than a majority of the Board of Directors of the Company (or any successor entity) thereafter; or (iii) during any period of two (2) consecutive years, individuals who at the beginning of such period constituted the Board of Directors of the Company (including for this purpose any new director whose election or nomination for election by the Company's shareholders was approved by a vote of at least two-thirds of the directors then still in office who were directors at the beginning of such period) (such directors being referred to herein as "**Continuing Directors**") cease for any reason to constitute at least a majority of the Board of Directors of the Company.

(c) “**Disinterested Director**” with respect to any request by the Indemnitee for indemnification or advancement of expenses hereunder shall mean a director of the Company who neither is nor was a party to the Proceeding (as defined below) in respect of which indemnification or advancement is being sought by the Indemnitee.

(d) The term “**Expenses**” shall mean, without limitation, expenses of Proceedings, including attorneys’ fees, disbursements and retainers, accounting and witness fees, expenses related to the preparation or service as a witness, travel and deposition costs, expenses of investigations, judicial or administrative proceedings and appeals, amounts paid in settlement of a Proceeding by or on behalf of the Indemnitee, costs of attachment or similar bonds, any expenses of attempting to establish or establishing a right to indemnification or advancement of expenses, under this Agreement, the Company’s Memorandum of Association and Articles of Association as currently in effect (the “**Articles**”), applicable law or otherwise, and reasonable compensation for time spent by the Indemnitee in connection with the investigation, defense or appeal of a Proceeding or action for indemnification for which the Indemnitee is not otherwise compensated by the Company or any third party. The term “Expenses” shall not include the amount of judgments, fines, interest or penalties, or excise taxes assessed with respect to any employee benefit or welfare plan, which are actually levied against or sustained by the Indemnitee to the extent sustained after final adjudication.

(e) The term “**Independent Legal Counsel**” shall mean any firm of attorneys reasonably selected by the Board of Directors of the Company, so long as such firm has not represented the Company, the Company’s subsidiaries or affiliates, the Indemnitee, any entity controlled by the Indemnitee, or any party adverse to the Company, within the preceding five (5) years. Notwithstanding the foregoing, the term “Independent Legal Counsel” shall not include any person who, under applicable standards of professional conduct then prevailing, would have a conflict of interest in representing either the Company or the Indemnitee in an action to determine the Indemnitee’s right to indemnification or advancement of Expenses under this Agreement, the Company’s Articles, applicable law or otherwise.

(f) The term “**Proceeding**” shall mean any threatened, pending or completed action, suit, arbitration, alternate dispute resolution mechanism, or any other proceeding (including, without limitation, an appeal therefrom), formal or informal, whether brought in the name of the Company or otherwise, whether of a civil, criminal, administrative or investigative nature, and whether by, in or involving a court or an administrative, other governmental or private entity or body (including, without limitation, an investigation by the Company or its Board of Directors), by reason of (i) the fact that the Indemnitee is or was a director/an executive officer of the Company, or is or was serving at the request of the Company as an agent of another enterprise, whether or not the Indemnitee is serving in such capacity at the time any liability or expense is incurred for which indemnification or reimbursement is to be provided under this Agreement, (ii) any actual or alleged act or omission or neglect or breach of duty, including, without limitation, any actual or alleged error or misstatement or misleading statement, which the Indemnitee commits or suffers while acting in any such capacity, or (iii) the Indemnitee attempting to establish or establishing a right to indemnification or advancement of Expenses pursuant to this Agreement, the Company’s Articles, applicable law or otherwise.

(g) The phrase “*servicing at the request of the Company as an agent of another enterprise*” or any similar terminology shall mean, unless the context otherwise requires, serving at the request of the Company as a director, officer, employee or agent of another corporation, partnership, joint venture, limited liability company, trust, employee benefit or welfare plan or other enterprise, foreign or domestic. The phrase “serving at the request of the Company” shall include, without limitation, any service as a director/an executive officer of the Company which imposes duties on, or involves services by, such director/an executive officer with respect to the Company or any of the Company’s subsidiaries, affiliates, employee benefit or welfare plans, such plan’s participants or beneficiaries or any other enterprise, foreign or domestic. In the event that the Indemnitee shall be a director, officer, employee or agent of another corporation, partnership, joint venture, limited liability company, trust, employee benefit or welfare plan or other enterprise, foreign or domestic, 50% or more of the ordinary shares, combined voting power or total equity interest of which is owned by the Company or any subsidiary or affiliate thereof, then it shall be presumed conclusively that the Indemnitee is so acting at the request of the Company.

2. **Services by the Indemnitee.** The Indemnitee agrees to serve as a director of the Company under the terms of the Indemnitee’s agreement with the Company for so long as the Indemnitee is duly elected and qualified, appointed or until such time as the Indemnitee tenders a resignation in writing or is removed as a director; provided, however, that the Indemnitee may at any time and for any reason resign from such position (subject to any other contractual obligation or other obligation imposed by operation of law).

3. **Proceeding Other Than a Proceeding by or in the Right of the Company.** The Company shall indemnify the Indemnitee if the Indemnitee is a party to or threatened to be made a party to or is otherwise involved in any Proceeding (other than a Proceeding by or in the right of the Company), by reason of the fact that the Indemnitee is or was a director/an executive officer of the Company, or is or was serving at the request of the Company as an agent of another enterprise, against all Expenses, judgments, fines, interest or penalties, and excise taxes assessed with respect to any employee benefit or welfare plan, which are actually and reasonably incurred by the Indemnitee in connection with such a Proceeding, to the fullest extent permitted by applicable law; provided, however, that any settlement of a Proceeding must be approved in advance in writing by the Company (which approval shall not be unreasonably withheld).

4. **Proceedings by or in the Right of the Company.** The Company shall indemnify the Indemnitee if the Indemnitee is a party to or threatened to be made a party to or is otherwise involved in any Proceeding by or in the right of the Company to procure a judgment in its favor by reason of the fact that the Indemnitee is or was a director/an executive officer of the Company, or is or was serving at the request of the Company as an agent of another enterprise, against all Expenses, judgments, fines, interest or penalties, and excise taxes assessed with respect to any employee benefit or welfare plan, which are actually and reasonably incurred by the Indemnitee in connection with such a Proceeding, to the fullest extent permitted by applicable law, if the Indemnitee acted in good faith and in a manner the Indemnitee reasonably believed to be in or not opposed to the best interests of the Company and, in the case of a criminal Proceeding, had no reasonable cause to believe that the conduct involved was unlawful; except that no indemnification under this section shall be made in respect of any claim, issue or matter as to which such person shall have been adjudicated by final judgment by a court of competent jurisdiction to be liable to the Company for willful misconduct in the performance of his/her duty to the Company, unless and only to the extent that the court in which such Proceeding was brought shall determine upon application that, despite the adjudication of liability but in view of all the circumstances of the case, such person is fairly and reasonably entitled to indemnity for such amounts which such other court shall deem proper.

5. **Indemnification for Costs, Charges and Expenses of Witness or Successful Party.** Notwithstanding any other provision of this Agreement (except as set forth in subparagraph 9(a) hereof), and without a requirement for determination as required by Paragraph 8 hereof, to the extent that the Indemnitee (a) has prepared to serve or has served as a witness in any Proceeding in any way relating to (i) the Company or any of the Company's subsidiaries, affiliates, employee benefit or welfare plans or such plan's participants or beneficiaries or (ii) anything done or not done by the Indemnitee as a director/an executive officer of the Company or in connection with serving at the request of the Company as an agent of another enterprise, or (b) has been successful, in whole or in part, in defense of any Proceeding or in defense of any claim, issue or matter therein, on the merits or otherwise, including the dismissal of a Proceeding without prejudice or the settlement of a Proceeding without an admission of liability, the Indemnitee shall be indemnified against all Expenses actually and reasonably incurred by the Indemnitee in connection therewith to the fullest extent permitted by applicable law. If the Indemnitee has been wholly unsuccessful in defense of any Proceeding or in defense of any claim, issue or matter therein, the Indemnitee shall be indemnified against all Expenses actually and reasonably incurred by the Indemnitee in connection therewith to the extent the Indemnitee acted in good faith and in a manner the Indemnitee reasonably believed to be in or not opposed to the best interests of the Company and, in the case of a criminal Proceeding, had no reasonable cause to believe that the conduct involved was unlawful.

6. **Partial Indemnification.** If the Indemnitee is entitled under any provision of this Agreement to indemnification by the Company for a portion of the Expenses, judgments, fines, interest or penalties, or excise taxes assessed with respect to any employee benefit or welfare plan, which are actually and reasonably incurred by the Indemnitee in the investigation, defense, appeal or settlement of any Proceeding, but not, however, for the total amount of the Indemnitee's Expenses, judgments, fines, interest or penalties, or excise taxes assessed with respect to any employee benefit or welfare plan, then the Company shall nevertheless indemnify the Indemnitee for the portion of such Expenses, judgments, fines, interest penalties or excise taxes to which the Indemnitee is entitled.

7. **Advancement of Expenses.** The Expenses incurred by the Indemnitee in any Proceeding shall be paid promptly by the Company in advance of the final disposition of the Proceeding at the written request of the Indemnitee to the fullest extent permitted by applicable law; provided, however, that the Indemnitee shall set forth in such request reasonable evidence that such Expenses have been incurred by the Indemnitee in connection with such Proceeding, a statement that such Expenses do not relate to any matter described in subparagraph 9(a) of this Agreement, and an undertaking in writing to repay any advances if it is ultimately determined as provided in subparagraph 8(b) of this Agreement that the Indemnitee is not entitled to indemnification under this Agreement.

8. **Indemnification Procedure; Determination of Right to Indemnification.**

(a) Promptly after receipt by the Indemnitee of notice of the commencement of any Proceeding, the Indemnitee shall, if a claim for indemnification or advancement of Expenses in respect thereof is to be made against the Company under this Agreement, notify the Company of the commencement thereof in writing. The omission to so notify the Company will not relieve the Company from any liability which the Company may have to the Indemnitee under this Agreement unless the Company shall have lost significant substantive or procedural rights with respect to the defense of any Proceeding as a result of such omission to so notify.

(b) The Indemnitee shall be conclusively presumed to have met the relevant standards of conduct, if any, as defined by applicable law, for indemnification pursuant to this Agreement and shall be absolutely entitled to such indemnification, unless a determination is made that the Indemnitee has not met such standards by a court of competent jurisdiction.

(c) If a claim for indemnification or advancement of Expenses under this Agreement is not paid by the Company within thirty (30) days after receipt by the Company of written notice thereof, the rights provided by this Agreement shall be enforceable by the Indemnitee in any court of competent jurisdiction. Such judicial proceeding shall be made de novo. The burden of proving that indemnification or advances are not appropriate shall be on the Company. Neither the failure of the directors or shareholders of the Company or Independent Legal Counsel to have made a determination prior to the commencement of such action that indemnification or advancement of Expenses is proper in the circumstances because the Indemnitee has met the applicable standard of conduct, if any, nor an actual determination by the directors or shareholders of the Company or Independent Legal Counsel that the Indemnitee has not met the applicable standard of conduct shall be a defense to an action by the Indemnitee or create a presumption for the purpose of such an action that the Indemnitee has not met the applicable standard of conduct. The termination of any Proceeding by judgment, order, settlement or conviction, or upon a plea of *nolo contendere* or its equivalent, shall not, of itself (i) create a presumption that the Indemnitee did not act in good faith and in a manner which he reasonably believed to be in the best interests of the Company and/or its shareholders, and, with respect to any criminal Proceeding, that the Indemnitee had reasonable cause to believe that his conduct was unlawful or (ii) otherwise adversely affect the rights of the Indemnitee to indemnification or advancement of Expenses under this Agreement, except as may be provided herein. The Company further agrees to stipulate in any such judicial proceeding that the Company is bound by all the provisions of this Agreement and is precluded from making any assertion to the contrary.

(d) The Company's obligations to indemnify the Indemnitee hereunder are primary in nature as to any other right to indemnification that the Indemnitee may be entitled to. The Company shall process Indemnitee's request for indemnification or advancement for Expenses immediately in accordance with the procedures set out herein and shall not decline a claim from the Indemnitee on the basis that the Indemnitee may have the right to seek indemnification under arrangements other than those contained hereunder.

(e) If a court of competent jurisdiction shall determine that the Indemnitee is entitled to any indemnification or advancement of Expenses hereunder, the Company shall pay all Expenses actually and reasonably incurred by the Indemnitee in connection with such adjudication (including, but not limited to, any appellate proceedings). The Indemnitee's Expenses incurred in connection with any Proceeding concerning the Indemnitee's right to indemnification or advancement of Expenses in whole or in part pursuant to this Agreement shall also be indemnified by the Company, regardless of the outcome of such a Proceeding, to the fullest extent permitted by applicable law and the Company's Articles.

(f) With respect to any Proceeding for which indemnification or advancement of Expenses is requested, the Company will be entitled to participate therein at its own expense and, except as otherwise provided below, to the extent that it may wish, the Company may assume the defense thereof, with counsel reasonably satisfactory to the Indemnitee. After notice from the Company to the Indemnitee of its election to assume the defense of a Proceeding, the Company will not be liable to the Indemnitee under this Agreement for any Expenses subsequently incurred by the Indemnitee in connection with the defense thereof, other than as provided below. The Company shall not settle any Proceeding in any manner which would impose any penalty or limitation on the Indemnitee without the Indemnitee's written consent. The Indemnitee shall have the right to employ his own counsel in any Proceeding, but the fees and expenses of such counsel incurred after notice from the Company of its assumption of the defense of the Proceeding shall be at the expense of the Indemnitee, unless (i) the employment of counsel by the Indemnitee has been authorized by the Company, (ii) the Indemnitee shall have reasonably concluded that there may be a conflict of interest between the Company and the Indemnitee in the conduct of the defense of a Proceeding, or (iii) the Company shall not in fact have employed counsel to assume the defense of a proceeding, in each of which cases the fees and expenses of the Indemnitee's counsel shall be advanced by the Company. The Company shall not be entitled to assume the defense of any Proceeding brought by or on behalf of the Company or as to which the Indemnitee has reasonably concluded that there may be a conflict of interest between the Company and the Indemnitee.



9. **Limitations on Indemnification**. No payments pursuant to this Agreement shall be made by the Company:

(a) To indemnify or advance funds to the Indemnitee for Expenses with respect to (i) Proceedings initiated or brought voluntarily by the Indemnitee and not by way of defense, except with respect to Proceedings brought to establish or enforce a right to indemnification under this Agreement or any other statute or law or otherwise as required under applicable law or (ii) Expenses incurred by the Indemnitee in connection with preparing to serve or serving, prior to a Change in Control, as a witness in cooperation with any party or entity who or which has threatened or commenced any action or proceeding against the Company, or any director, officer, employee, trustee, agent, representative, subsidiary, parent corporation or affiliate of the Company, but such indemnification or advancement of Expenses in each such case may be provided by the Company if the Board of Directors finds it to be appropriate;

(b) To indemnify the Indemnitee for any Expenses, judgments, fines, interest or penalties, or excise taxes assessed with respect to any employee benefit or welfare plan, and sustained in any Proceeding for which payment is actually made to the Indemnitee under a valid and collectible insurance policy carried out by the Company, except in respect of any excess beyond the amount of payment under such insurance;

(c) To indemnify the Indemnitee for any Expenses, judgments, fines, interest or penalties sustained in any Proceeding for an accounting of profits made from the purchase or sale by the Indemnitee of securities of the Company pursuant to the provisions of Section 16(b) of the Act or similar provisions of any foreign or United States federal, state or local statute or regulation;

(d) To indemnify the Indemnitee for any Expenses, judgments, fines, interest or penalties, or excise taxes assessed with respect to any employee benefit or welfare plan, for which the Indemnitee is fully indemnified by the Company otherwise than pursuant to this Agreement;

(e) To indemnify the Indemnitee for any Expenses (including without limitation any Expenses relating to a Proceeding attempting to enforce this Agreement), judgments, fines, interest or penalties, or excise taxes assessed with respect to any employee benefit or welfare plan, on account of the Indemnitee's conduct if such conduct shall be finally adjudged to have been knowingly fraudulent, deliberately dishonest or willful misconduct, including, without limitation, breach of the duty of loyalty;

(f) If a court of competent jurisdiction finally determines that any indemnification hereunder is unlawful;

(g) To indemnify the Indemnitee in connection with Indemnitee's personal tax matter; or

(h) To indemnify the Indemnitee with respect to any claim related to any dispute or breach arising under any contract or similar obligation between the Company or any of its subsidiaries or affiliates and such Indemnitee.

**10. Contribution in the Event of Joint Liability.**

(a) To the fullest extent not prohibited by (and not merely to the extent affirmatively permitted by) law, if the indemnification rights provided for in this Agreement are unavailable to the Indemnitee in whole or in part for any reason whatsoever, in respect of any Proceeding in which the Company is jointly liable with the Indemnitee (or would be if joined in such Proceeding), the Company, in lieu of indemnifying the Indemnitee, shall pay, in the first instance, the entire amount incurred by the Indemnitee, whether for judgments, liabilities, fines, penalties, amounts paid or to be paid in settlement and/or for Expenses, without requiring the Indemnitee to contribute to such payment, and the Company hereby waives and relinquishes any right of contribution it may have at any time against the Indemnitee.

(b) The Company shall not enter into any settlement of any Proceeding in which the Company is jointly liable with the Indemnitee (or would be if joined in such Proceeding) unless such settlement provides for a full and final release of all claims asserted against the Indemnitee.

(c) The Company hereby agrees to fully indemnify, hold harmless and exonerate the Indemnitee from any claims for contribution which may be brought by officers, directors or employees of the Company (other than the Indemnitee) who may be jointly liable with the Indemnitee.

**11. Continuation of Indemnification.** All agreements and obligations of the Company contained herein shall continue during the period that the Indemnitee is a director/an executive officer of the Company (or is or was serving at the request of the Company as an agent of another enterprise, foreign or domestic), regardless of whether the Indemnitee was appointed before or after the date of this Agreement and shall continue thereafter so long as the Indemnitee shall be subject to any possible Proceeding by reason of the fact that the Indemnitee was a director/an executive officer of the Company or serving in any other capacity referred to in this Paragraph 11.

**12. Indemnification Hereunder Not Exclusive.** The indemnification provided by this Agreement shall not be deemed to be exclusive of any other rights to which the Indemnitee may be entitled under the Company's Articles, any agreement, vote of shareholders or vote of Disinterested Directors, provisions of applicable law, or otherwise, both as to action or omission in the Indemnitee's official capacity and as to action or omission in another capacity on behalf of the Company while holding such office.

**13. Successors and Assigns.**

(a) This Agreement shall be binding upon, and shall inure to the benefit of, the Indemnitee and the Indemnitee's heirs, executors, administrators and assigns, whether or not the Indemnitee has ceased to be a director/an executive officer, and the Company and its successors and assigns. Upon the sale of all or substantially all of the business, assets or share capital of the Company to, or upon the merger of the Company into or with, any corporation, partnership, joint venture, trust or other person, this Agreement shall inure to the benefit of and be binding upon both the Indemnitee and such purchaser or successor person. Subject to the foregoing, this Agreement may not be assigned by either party without the prior written consent of the other party hereto.

(b) If the Indemnitee is deceased and is entitled to indemnification under any provision of this Agreement, the Company shall indemnify the Indemnitee's estate and the Indemnitee's spouse, heirs, executors, administrators and assigns against, and the Company shall, and does hereby agree to assume, any and all Expenses actually and reasonably incurred by or for the Indemnitee or the Indemnitee's estate, in connection with the investigation, defense, appeal or settlement of any Proceeding. Further, when requested in writing by the spouse of the Indemnitee, and/or the Indemnitee's heirs, executors, administrators and assigns, the Company shall provide appropriate evidence of the Company's agreement set out herein to indemnify the Indemnitee against and to itself assume such Expenses.

14. **Subrogation.** In the event of payment under this Agreement, the Company shall be subrogated to the extent of such payment to all of the rights of recovery of the Indemnitee, who shall execute all documents required and shall do all acts that may be necessary to secure such rights and to enable the Company effectively to bring suit to enforce such rights.

15. **Severability.** Each and every paragraph, sentence, term and provision of this Agreement is separate and distinct so that if any paragraph, sentence, term or provision thereof shall be held to be invalid, unlawful or unenforceable for any reason, such invalidity, unlawfulness or unenforceability shall not affect the validity, unlawfulness or enforceability of any other paragraph, sentence, term or provision hereof. To the extent required, any paragraph, sentence, term or provision of this Agreement may be modified by a court of competent jurisdiction to preserve its validity and to provide the Indemnitee with the broadest possible indemnification permitted under applicable law. The Company's inability, pursuant to a court order or decision, to perform its obligations under this Agreement shall not constitute a breach of this Agreement.

16. **Savings Clause.** If this Agreement or any paragraph, sentence, term or provision hereof is invalidated on any ground by any court of competent jurisdiction, the Company shall nevertheless indemnify the Indemnitee as to any Expenses, judgments, fines, interest or penalties, or excise taxes assessed with respect to any employee benefit or welfare plan, which are incurred with respect to any Proceeding to the fullest extent permitted by any (a) applicable paragraph, sentence, term or provision of this Agreement that has not been invalidated or (b) applicable law.

17. **Interpretation; Governing Law.** This Agreement shall be construed as a whole and in accordance with its fair meaning and any ambiguities shall not be construed for or against either party. Headings are for convenience only and shall not be used in construing meaning. This Agreement shall be governed and interpreted in accordance with the laws of the Cayman Islands without regard to the conflict of laws principles thereof.

18. **Amendments**. No amendment, waiver, modification, termination or cancellation of this Agreement shall be effective unless in writing signed by the party against whom enforcement is sought. The indemnification rights afforded to the Indemnitee hereby are contract rights and may not be diminished, eliminated or otherwise affected by amendments to the Company's Articles, or by other agreements, including directors' and officers' liability insurance policies, of the Company.

19. **Counterparts**. This Agreement may be executed in one or more counterparts, all of which shall be considered one and the same agreement and shall become effective when one or more counterparts have been signed by each party and delivered to the other.

20. **Notices**. Any notice required to be given under this Agreement shall be directed to Belite Bio, Inc at 5820 Oberlin Drive, Suite 101, San Diego, CA 92121, and to the Indemnitee at \_\_\_\_\_ or to such other address as either shall designate to the other in writing.

[Signatures on the Next Page]

IN WITNESS WHEREOF, the parties have executed this Indemnification Agreement as of the date first written above.

**INDEMNITEE**

\_\_\_\_\_  
Name:

**Belite Bio, Inc**

By: \_\_\_\_\_  
Name:  
Title:

*[Signature Page to the Indemnification Agreement]*

---

**SERIES A PREFERRED SHARE PURCHASE AND NOTE CONVERSION AGREEMENT**

THIS SERIES A PREFERRED SHARE PURCHASE AGREEMENT (this "Agreement") is made and entered into on January 21, 2020 by and among:

1. Belite Bio, Inc, an exempted company organized under the Laws of the Cayman Islands (the "Company"),
2. each of the Persons listed in Schedule I attached hereto (each, a "Note Holder" and collectively, the "Note Holders"), and
3. each of the Persons listed on Schedule II attached hereto (each, an "Investor" and collectively, the "Investors").

Each of the parties to this Agreement is referred to herein individually as a "Party" and collectively as the "Parties".

**RECITALS**

- A. The Company is engaged in the business of drug development (the "Business"). The Company seeks expansion capital to grow the Business and, correspondingly, seeks to secure an investment from the Investors, on the terms and conditions set forth herein.
- B. The Note Holders hold the Notes and seek to convert the unpaid principal and interest accrued thereon into Series A Preferred Shares (as defined below) pursuant to the terms and subject to the conditions of this Agreement.
- C. The Investors wish to invest in the Company by subscribing for Series A Preferred Shares to be issued by the Company pursuant to the terms and subject to the conditions of this Agreement, and the Company wishes to issue and sell Series A Preferred Shares to the Investors pursuant to the terms and subject to the conditions of this Agreement.
- D. The Parties desire to enter into this Agreement and make the respective representations, warranties, covenants and agreements set forth herein on the terms and conditions set forth herein.

**WITNESSETH**

NOW, THEREFORE, in consideration of the foregoing recitals, the mutual promises hereinafter set forth, and other good and valuable consideration, the receipt and sufficiency of which are hereby acknowledged, the Parties intending to be legally bound hereto hereby agree as follows:

**1. Definitions.**

**1.1** Capitalized terms used and not otherwise defined herein shall have the meaning ascribed to them below:

"Accounting Standards" means International Financial Reporting Standards as promulgated from time to time by the International Accounting Standards Board (the "IASB") (including, without limitation, standards and interpretations approved by the IASB and International Accounting Principles issued under previous constitutions thereof), together with the IASB's pronouncements thereon from time to time, applied on a consistent basis.

“Action” means any charge, claim, action, complaint, petition, investigation, appeal, suit, litigation, grievance, inquiry or other proceeding, whether administrative, civil, regulatory or criminal, whether at law or in equity, or otherwise under any applicable Law, and whether or not before any mediator, arbitrator or Governmental Authority.

“Affiliate” means, with respect to a Person, any other Person that, directly or indirectly, Controls, is Controlled by or is under common Control with such Person. In the case of an Investor, the term “Affiliate” also includes (v) any Controlling shareholder of the Investor, (w) any of such shareholder's or Investors' general partners or limited partners, (x) the fund manager managing such shareholder or Investor (and general partners, limited partners and officers thereof) and other funds managed by such fund manager, and (y) trusts controlled by or for the benefit of any such Person referred to in (v), (w) or (x).

“Associate” means, with respect to any Person, (1) a corporation or organization (other than the Group Companies) of which such Person is an officer or partner or is, directly or indirectly, the record or beneficial owner of ten (10) percent or more of any class of Equity Securities of such corporation or organization, (2) any trust or other estate in which such Person has a substantial beneficial interest or as to which such Person serves as trustee or in a similar capacity, or (3) any relative or spouse of such Person, or any relative of such spouse.

“Benefit Plan” means any employment Contract, deferred compensation Contract, bonus plan, incentive plan, profit sharing plan, mandatory provident scheme, occupational retirement scheme, retirement Contract or other employment compensation Contract or any other plan which provides or provided benefits for any past or present employee, officer, consultant, and/or director of a Person or with respect to which contributions are or have been made on account of any past or present employee, officer, consultant, and/or director of such a Person.

“Board” or “Board of Directors” means the board of directors of the Company.

“Business Day” means any day that is not a Saturday, Sunday, legal holiday or other day on which commercial banks are required or authorized by law to be closed in the PRC, Taiwan, or the United States.

“CFC” means a controlled foreign corporation as defined in the Code.

“Charter Documents” means, with respect to a particular legal entity, the articles of incorporation, certificate of incorporation, formation or registration (including, if applicable, certificates of change of name), memorandum of association, articles of association, bylaws, articles of organization, limited liability company agreement, trust deed, trust instrument, operating agreement, joint venture agreement, business license, or similar or other constitutive, governing, or charter documents, or equivalent documents, of such entity.

“Code” means the United States Internal Revenue Code of 1986, as amended.

“Company Owned IP” means all Intellectual Property owned by, purported to be owned by, or exclusively licensed to, the Group Companies.

“Company Registered IP” means all Intellectual Property for which registrations are owned by or held in the name of, or for which applications have been made in the name of, any Group Company.

“Consent” means any consent, approval, authorization, release, waiver, permit, grant, franchise, concession, agreement, license, exemption or order of, registration, certificate, declaration or filing with, or report or notice to, any Person, including any Governmental Authority.

“Contract” means a contract, agreement, indenture, note, bond, loan, instrument, lease, mortgage, franchise, license, commitment, purchase order, and other legally binding arrangement, whether written or oral.

“Control” of a given Person means the power or authority, whether exercised or not, to direct the business, management and policies of such Person, directly or indirectly, whether through the ownership of voting securities, by Contract or otherwise; provided, that such power or authority shall conclusively be presumed to exist upon possession of beneficial ownership or power to direct the vote of more than fifty percent (50%) of the votes entitled to be cast at a meeting of the members or shareholders of such Person or power to control the composition of a majority of the board of directors of such Person. The terms “Controlled” and “Controlling” have meanings correlative to the foregoing.

“Conversion Shares” means Ordinary Shares issuable upon conversion of any Shares.

“Equity Securities” means, with respect to any Person that is a legal entity, any and all shares of capital stock, membership interests, units, profits interests, ownership interests, equity interests, registered capital, and other equity securities of such Person, and any right, warrant, option, call, commitment, conversion privilege, preemptive right or other right to acquire any of the foregoing, or security convertible into, exchangeable or exercisable for any of the foregoing.

“FCPA” means Foreign Corrupt Practices Act of the United States of America, as amended from time to time.

“Governmental Authority” means any government of any nation, federation, province or state or any other political subdivision thereof, any entity, authority or body exercising executive, legislative, judicial, regulatory or administrative functions of or pertaining to government, including any governmental authority, agency, department, board, commission or instrumentality of the PRC or any other country, or any political subdivision thereof, any court, tribunal or arbitrator, and any self-regulatory organization.



“Governmental Order” means any applicable order, ruling, decision, verdict, decree, writ, subpoena, mandate, precept, command, directive, consent, approval, award, judgment, injunction or other similar determination or finding by, before or under the supervision of any Governmental Authority.

“Group Company” means the Company, together with its Subsidiary of any of the foregoing, and “Group” refers to all of Group Companies collectively.

“Hong Kong” means the Hong Kong Special Administrative Region of the People’s Republic of China.

“Indebtedness” of any Person means, without duplication, each of the following of such Person: (i) all indebtedness for borrowed money, (ii) all obligations issued, undertaken or assumed as the deferred purchase price of property or services (other than trade payables entered into in the ordinary course of business), (iii) all reimbursement or payment obligations with respect to letters of credit, surety bonds and other similar instruments, (iv) all obligations evidenced by notes, bonds, debentures or similar instruments, including obligations so evidenced that are incurred in connection with the acquisition of properties, assets or businesses, (v) all indebtedness created or arising under any conditional sale or other title retention agreement, or incurred as financing, in either case with respect to any property or assets acquired with the proceeds of such indebtedness (even though the rights and remedies of the seller or bank under such agreement in the event of default are limited to repossession or sale of such property), (vi) all obligations that are capitalized (including capitalized lease obligations), (vii) all obligations under banker’s acceptance, letter of credit or similar facilities, (viii) all obligations to purchase, redeem, retire, defease or otherwise acquire for value any Equity Securities of such Person, (ix) all obligations in respect of any interest rate swap, hedge or cap agreement, and (x) all guarantees issued in respect of the Indebtedness referred to in clauses (i) through (ix) above of any other Person, but only to the extent of the Indebtedness guaranteed.

“Intellectual Property” means any and all (i) patents, patent rights and applications therefor and reissues, reexaminations, continuations, continuations-in-part, divisions, and patent term extensions thereof, (ii) inventions (whether patentable or not), discoveries, improvements, concepts, innovations and industrial models, (iii) registered and unregistered copyrights, copyright registrations and applications, mask works and registrations and applications therefor, author’s rights and works of authorship (including artwork, software, computer programs, source code, object code and executable code, firmware, development tools, files, records and data, and related documentation), (iv) URLs, web sites, web pages and any part thereof, (v) technical information, know-how, trade secrets, drawings, designs, design protocols, specifications, proprietary data, customer lists, databases, proprietary processes, technology, formulae, and algorithms and other intellectual property, (vi) trade names, trade dress, trademarks, domain names, service marks, logos, business names, and registrations and applications therefor, and (vii) the goodwill symbolized or represented by the foregoing.

“Key Employee” means all employees of the Group Companies listed on Schedule IV.

“Knowledge” means, with respect to the Company, the actual knowledge of any of the Key Employees, and that knowledge which should have been acquired by each such individual after making such due inquiry and exercising such due diligence as a prudent business person would have made or exercised in the management of his or her business affairs.

“Law” or “Laws” means any and all provisions of any applicable constitution, treaty, statute, law, regulation, ordinance, code, rule, or rule of common law, any governmental approval, concession, grant, franchise, license, agreement, directive, requirement, or other governmental restriction or any similar form of decision of, or determination by, or any interpretation or administration of any of the foregoing by, any Governmental Authority, in each case as amended, and any and all applicable Governmental Orders.

“Liabilities” means, with respect to any Person, all liabilities, obligations and commitments of such Person of any nature, whether accrued, absolute, contingent or otherwise, and whether due or to become due.

“Lien” means any claim, charge, easement, encumbrance, lease, covenant, security interest, lien, option, pledge, rights of others, or restriction (whether on voting, sale, transfer, disposition or otherwise), whether imposed by Contract, understanding, law, equity or otherwise.

“Material Adverse Effect” means any (i) event, occurrence, fact, condition, change or development that has had, has, or could reasonably be expected to have, individually or together with other events, occurrences, facts, conditions, changes or developments, a material adverse effect on the business, properties, assets, employees, operations, results of operations, condition (financial or otherwise), prospects, assets or liabilities of the Group taken as a whole, (ii) material impairment of the ability of any Party (other than the Investors) to perform the material obligations of such party under any Transaction Documents, or (iii) material impairment of the validity or enforceability of this Agreement or any other Transaction Document against any Party hereto or thereto (other than the Investors).

“Memorandum and Articles” means the amended and restated memorandum of association of the Company and the amended and restated articles of association of the Company attached hereto as Exhibits A-1 and Exhibit A-2, respectively, to be adopted in accordance with applicable Law on or before the Closing.

“MOFCOM” means the Ministry of Commerce of the PRC or, with respect to any matter to be submitted for examination and approval by the Ministry of Commerce, any Governmental Authority which is delegated or authorized by the Ministry of Commerce to examine and approve such matter under the laws of the PRC.

“Note Purchase Agreement” means all the note purchase agreement between the Company and the Note Holders, as listed in Schedule I.

“Note” means all the convertible promissory notes issued by the Company pursuant to the Note Purchase Agreement, as listed in Schedule I.

“Ordinary Shares” means the Company’s ordinary shares, par value US\$0.0001 per share.

“Permitted Liens” means (i) Liens for Taxes not yet delinquent or the validity of which are being contested in good faith and for which there are adequate reserves on the applicable financial statements, and (ii) Liens incurred in the ordinary course of business, which (x) do not individually or in the aggregate materially detract from the value, use, or transferability of the assets that are subject to such Liens, and (y) were not incurred in connection with the borrowing of money.

“Person” means any individual, corporation, partnership, limited partnership, proprietorship, association, limited liability company, firm, trust, estate or other enterprise or entity.

“PFIC” means a passive foreign investment company as defined in the Code.

“PRC” means the People’s Republic of China, but solely for the purposes of this Agreement and the other Transaction Documents, excluding Hong Kong, the Macau Special Administrative Region and the islands of Taiwan.

“Prohibited Person” means any Person that is (1) a national or resident of any U.S. embargoed or restricted country, (2) included on, or Affiliated with any Person on, the United States Commerce Department’s Denied Parties List, Entities and Unverified Lists; the U.S. Department of Treasury’s Specially Designated Nationals, Specially Designated Narcotics Traffickers or Specially Designated Terrorists, or the Annex to Executive Order No. 13224; the Department of State’s Debarred List; UN Sanctions, (3) a member of any PRC military organization, or (4) a Person with whom business transactions, including exports and re-exports, are restricted by a U.S. Governmental Authority, including, in each clause above, any updates or revisions to the foregoing and any newly published rules.

“Public Official” means any executive, official, or employee of a Governmental Authority, political party or member of a political party, political candidate; executive, employee or officer of a public international organization; or director, officer or employee or agent of a wholly owned or partially state-owned or controlled enterprise.

“Related Party” means any Affiliate, officer, director, supervisory board member, employee, or holder of any Equity Security of any Group Company, and any Affiliate or Associate of any of the foregoing.

“SAFE” means the State Administration of Foreign Exchange of the PRC.

“SAMR” means the State Administration for Market Regulation of the PRC or, with respect to the issuance of any business license or filing or registration to be effected by or with the State Administration for Market Regulation, any Governmental Authority which is similarly competent to issue such business license or accept such filing or registration under the laws of the PRC.

“Securities Act” means the U.S. Securities Act of 1933, as amended and interpreted from time to time.

“Series A Preferred Shares” means the Series A Preferred Shares of the Company, par value US\$0.0001 per share, with the rights and privileges as set forth in the Memorandum and Articles.

“Shareholders Agreement” means the Shareholders Agreement to be entered into by and among the parties named therein on or prior to the Closing, which shall be in the form attached hereto as Exhibit B.

“Shares” means the Series A Preferred Shares issued to the Investors and Note Holders hereunder.

“Social Insurance” means any form of social insurance required under applicable Laws, including without limitation, the PRC national and local contributions for pensions, medical insurance, unemployment insurance, work-related injury insurance, pregnancy benefits, and housing accumulation funds.

“Subsidiary” means, with respect to any given Person, any other Person that is Controlled directly or indirectly by such given Person.

“Tax” means (i) in the PRC: (a) any national, provincial, municipal, or local taxes, charges, fees, levies, or other assessments, including, without limitation, all net income (including enterprise income tax and individual income withholding tax), turnover (including value-added tax, business tax, and consumption tax), resource (including urban and township land use tax), special purpose (including land value-added tax, urban maintenance and construction tax, and additional education fees), property (including urban real estate tax and land use fees), documentation (including stamp duty and deed tax), filing, recording, social insurance (including pension, medical, unemployment, housing, and other social insurance withholding), tariffs (including import duty and import value-added tax), and estimated and provisional taxes, charges, fees, levies, or other assessments of any kind whatsoever, (b) all interest, penalties (administrative, civil or criminal), or additional amounts imposed by any Governmental Authority in connection with any item described in clause (a) above, and (c) any form of transferee liability imposed by any Governmental Authority in connection with any item described in clauses (a) and (b) above and (ii) in any jurisdiction other than the PRC: all similar liabilities as described in clause (i)(a) and (i)(b) above.

“Tax Return” means any return, report or statement showing Taxes, used to pay Taxes, or required to be filed with respect to any Tax (including any elections, declarations, schedules or attachments thereto, and any amendment thereof), including any information return, claim for refund, amended return or declaration of estimated or provisional Tax.

“Transaction Documents” means this Agreement, the Shareholders Agreement, the Memorandum and Articles, and each of the other agreements and documents otherwise required in connection with implementing the transactions contemplated by any of the foregoing.

“U.S. real property holding corporation” has the meaning as defined in the Code.

**1.2 Other Defined Terms.** The following terms shall have the meanings defined for such terms in the Sections set forth below:

Agreement	Preamble
Arbitration Notice	Section 9.4(i)
Annual Statement Date	Section 3.10
Balance Sheet	Section 3.10
Business	Preamble
Closing	Section 2.3(i)
Company	Preamble
Company IP	Section 3.15(i)
Compliance Laws	Section 3.13(i)
Disclosure Schedule	Section 3
Dispute	Section 9.4(i)
ESOP	Section 3.2(i)
Financial Statements	Section 3.10
HKIAC	Section 9.4(ii)
HKIAC Rules	Section 9.4(ii)
Investor/Investors	Preamble
Licenses	Section 3.15(v)
Party/Parties	Preamble
Principal	Preamble
Purchase Price	Section 2.1
Representatives	Section 3.13(i)
SEC	Section 4.3
Shares	Section 2.1
Statement Date	Section 3.10

**2. Purchase and Sale of Shares.**

**2.1 Conversion of Notes and Issuance of the Series A-1 Preferred Shares at Closing.** Subject to the terms and conditions of this Agreement, at the Closing (as defined below), the Note Holders have elected, and the Company agrees, to convert the Notes, with total outstanding principal amount of US\$2,000,000 and accrued but unpaid interest thereon of US\$ 13,835.62 as of January 31, 2020 into a total number of 543,750 Series A Preferred Shares, with each Note Holder converting all Notes held thereby into such number of Series A Preferred Shares as set forth opposite to such Note Holder’s name in Schedule I attached hereto.

**2.2 Sale and Issuance of the Shares.** Subject to the terms and conditions of this Agreement, at the Closing (as defined below), each Investor, severally and not jointly, agrees to subscribe for and purchase, and the Company agrees to issue and sell to such Investor, that number of Series A Preferred Shares set forth opposite such Investor's name on Schedule II attached hereto, with each Investor to pay as consideration for such Shares the aggregate purchase price set forth opposite such Investor's name on Schedule II attached hereto (the "Purchase Price").

**2.3 Closing.**

(i) **Closing.** The consummation of the sale and issuance of the Shares pursuant to Section 2.1 (the "Closing") shall take place remotely via the exchange of documents and signatures as soon as practicable, but in no event later than three (3) Business Days after all closing conditions specified in Section 6 and Section 7 hereof have been waived or satisfied (other than those conditions to be satisfied at the Closing, but subject to the satisfaction or waiver thereof at the Closing), or at such other time and place as the Company and the Investors and the Note Holders shall mutually agree in writing.

(ii) **Deliveries by the Company at Closing.** At the Closing, in addition to any items the delivery of which is made an express condition to the Investor's and the Note Holders' obligations at the Closing pursuant to Section 6, the Company shall deliver to each Investor and each Note Holder (a) a scanned copy of the updated register of members of the Company, reflecting the issuance of Shares, and (b) a copy of duly executed certificate or certificates issued in the name of such Investor and Note Holder representing the Shares being purchased by such Investor and Note Holder at the Closings. Within ten (10) Business Days after the Closing, the Company shall deliver to the Investors and the Note Holders the original share certificates representing the Shares being purchased by such Investors and the Note Holders.

(iii) **Deliveries by the Investors at Closing.** At the Closing, subject to the satisfaction or waiver of all the conditions set forth in Section 6 below, each Investor shall pay the Purchase Price by wire transfer of immediately available funds in U.S. dollars to the bank account as set forth in Schedule V attached hereto or any other bank account designated by the Company in writing.

(iv) **Deliveries by the Note Holders at Closing.** At the Closing, subject to the satisfaction or waiver of all the conditions set forth in Section 6 below, each Note Holder shall immediately surrender all Notes held by such Note Holder, or in case of a lost note, an affidavit of loss, damage or mutilation and agreement to indemnify the Company pursuant to section 10 of each Note, to the Company for cancellation. Upon update of register of members of the Company in consideration for surrender and cancellation of the Notes, (i) all obligations of the Company in favor of the Note Holders pursuant to the Note Purchase Agreement and the Notes shall be deemed fully discharged and the Note Purchase Agreement shall be terminated and (ii) the Note Holders shall have no further rights or claims under or in respect of such Notes. Immediately following the Closing, whether or not surrendered, the Notes shall be deemed to be null and void; provided that a Note which was not surrendered at the Closing shall continue to represent the right to receive the shares that the Note Holder is entitled to receive upon surrender of such Note which have not otherwise been issued in respect of such Note.

(v) If, at the Closing, any Investor shall fail to perform its obligations to fund its Purchase Price pursuant to Section 2.3(iii), or any Note Holder shall fail to surrender all the Notes held thereby pursuant to Section 2.3(iv) and Section 7.4, the Closing shall take place with respect to the other Investors and Note Holders. The closing with respect to such Investor or Note Holder shall take place until such time they have fulfilled their obligations hereunder but in any event no later than January 31, 2020 (the “Long Stop Date”) unless otherwise mutually agreed by the Company and such investor. The Company shall not be obliged to proceed with the closing with any such investor or note holder after the Long Stop Date.

**3. Representations and Warranties of the Company.** Subject to such exceptions as may be specifically set forth in the disclosure schedule delivered by the Company to the Investors and the Note Holders as of the date hereof and attached hereto as Schedule VI (the “Disclosure Schedule”) which forms part of the representation and warranties herein, the Company represents and warrants to the Investors and the Note Holders that the following statements are true and correct as of the date hereof and as of the Closing:

**3.1 Organization, Good Standing and Qualification.** Each Group Company is duly organized, validly existing and in good standing (or equivalent status in the relevant jurisdiction) under, and by virtue of, the Laws of the place of its incorporation or establishment and has all requisite power and authority to own its properties and assets and to carry on its business as now conducted, and to perform each of its obligations under the Transaction Documents to which it is a party. Each Group Company is qualified to do business and is in good standing (or equivalent status in the relevant jurisdiction) in each jurisdiction where failure to be so qualified would be a Material Adverse Effect. Each Group Company has a valid business license issued by the relevant Government Authorities, and has, since its establishment, carried on its Business materially in compliance with the business scope set forth in its business license.

**3.2 Capitalization and Voting Rights.**

(i) **Company.** The authorized share capital of the Company is and immediately prior to the Closing shall be US\$50,000 divided into (a) a total of 497,500,000 authorized Ordinary Shares, 8,840,321 of which are issued and outstanding, and 1,960,080 of which have been reserved for issuance to officers, directors, employees, consultants or service providers of the Company pursuant to an equity incentive plan of the Company (the “ESOP”); and (b) a total of 2,500,000 authorized Series A Preferred Shares, none of which are issued and outstanding. Section 3.2(i) of the Disclosure Schedule set forth the capitalization table of each Group Company as of immediately prior to the Closing, and immediately after the Closing, in each case reflecting all the outstanding and authorized Equity Securities of such Group Company, the record and beneficial holders thereof, the issuance date, and the terms of any vesting applicable thereto.

(ii) **No Other Securities.** Except for (a) the conversion privileges of the Series A Preferred Share, and (b) certain rights provided in the Memorandum and Article and the Shareholders Agreement, (1) there are no and at the Closing there shall be no other authorized or outstanding Equity Securities of any Group Company; (2) no Equity Securities of any Group Company are subject to any preemptive rights, rights of first refusal or other rights to purchase such Equity Securities or any other rights with respect to such Equity Securities, and (3) no Group Company is a party or subject to any Contract that affects or relates to the voting or giving of written consents with respect to, or the right to cause the redemption, or repurchase of, any Equity Security of such Group Company. Except as set forth in the Shareholders Agreement, the Company has not granted any registration or information rights to any other Person, nor is the Company obliged to list, any of the Equity Securities of any Group Companies on any securities exchange. Except as contemplated under the Transaction Documents, there are no voting or similar agreements which relate to the share capital or registered capital of any Group Company.

(iii) **Issuance and Status.** All share capital or registered capital, as the case may be, of each Group Company have been duly and validly issued, are fully paid (or subscribed for) and nonassessable, and are and as of the Closing shall be free of any and all Liens (except for any restrictions on transfer under the Shareholders Agreement and applicable Laws). Except as contemplated under the Transaction Documents, there are no (a) resolutions pending to increase the share capital or registered capital of any Group Company or cause the liquidation, winding up, or dissolution of any Group Company, nor has any distress, execution or other process been levied against any Group Company, (b) dividends which have accrued or been declared but are unpaid by any Group Company, (c) obligations, contingent or otherwise, of any Group Company to repurchase, redeem, or otherwise acquire any Equity Securities, or (d) outstanding or authorized equity appreciation, phantom equity, equity plans or similar rights with respect to any Group Company. All dividends (if any) or distributions (if any) declared, made or paid by each Group Company, and all repurchases and redemptions of Equity Securities of each Group Company (if any), have been declared, made, paid, repurchased or redeemed, as applicable, in accordance with its Charter Documents and all applicable Laws.

(iv) **Title.** Each Group Company is the sole record and beneficial holder of all of the Equity Securities set forth opposite its name on Section 3.2(i) of the Disclosure Schedule, free and clear of all Liens of any kind other than those arising under applicable Law or as set forth in the Transaction Documents.

**3.3 Corporate Structure; Subsidiaries.** Section 3.3 of the Disclosure Schedule sets forth a complete structure chart showing Group Companies, and indicating the ownership and Control relationships among all Group Companies, the nature of the legal entity which each Group Company constitutes, the jurisdiction in which each Group Company was organized, and each jurisdiction in which each Group Company is required to be qualified or licensed to do business as a foreign Person. No Group Company owns or Controls, or has ever owned or Controlled, directly or indirectly, any Equity Security, interest or share in any other Person or is or was a participant in any joint venture, partnership or similar arrangement. No Group Company is obligated to make any investment in or capital contribution in or on behalf of any other Person.



**3.4 Authorization.** The Company has all requisite power and authority to execute and deliver the Transaction Documents to which it is a party and to carry out and perform its obligations thereunder. The authorization, issuance (or reservation for issuance), sale and delivery of the Shares and the reservation for issuance the Conversion Shares, has been taken or will be taken prior to the Closing or at the Closing, as applicable. Each Transaction Document, when executed and delivered, constitutes valid and legally binding obligations of such party, enforceable against such party in accordance with its terms, except (i) as limited by applicable bankruptcy, insolvency, reorganization, moratorium, and other Laws of general application affecting enforcement of creditors' rights generally, and (ii) as limited by Laws relating to the availability of specific performance, injunctive relief, or other equitable remedies.

**3.5 Valid Issuance of Shares.** The Shares, when issued, delivered and paid for in accordance with the terms of this Agreement for the consideration expressed herein, will be duly and validly issued, fully paid and non-assessable, free from any Liens (except for any restrictions on transfer under applicable Laws and under the Shareholders Agreement). The Conversion Shares will be reserved at Closing for issuance and, upon issuance in accordance with the terms of the Memorandum and Articles, will be duly and validly issued, fully paid and non-assessable, free from any Liens (except for any restrictions on transfer under applicable securities Laws and under the Shareholders Agreement). The issuance of the Shares and the Conversion Shares will not be subject to any preemptive rights, rights of first refusal or similar rights other than those that have been or will be duly waived prior to or at the Closing, as applicable.

**3.6 Consents; No Conflicts.** All Consents from or with any Governmental Authority or any other Person required in connection with the execution, delivery and performance of the Transaction Documents by the Company, and the consummation of the transactions contemplated by the Transaction Documents by the Company, have been duly obtained or completed (as applicable) and are in full force and effect. The execution, delivery and performance of each Transaction Document by the Company do not, and the consummation by the Company of the transactions contemplated thereby will not, with or without notice or lapse of time or both, (i) result in any violation of, be in conflict with, or constitute a default under any provision of any Charter Document of the Company, or (ii) result in any violation of, be in conflict with, or constitute a default under, in any material respect, any Governmental Order or any applicable Law.

**3.7 Offering.** Subject in part to the accuracy of the Investors' representations and the Note Holders' representations set forth in [Section 4](#) and [5](#) of this Agreement, the offer, sale and issuance of the Shares are, and the issuance of the Conversion Shares will be, exempt from the qualification, registration and prospectus delivery requirements of the Securities Act and any other applicable securities Laws.

**3.8 Compliance with Laws; Consents.**

(i) Each Group Company is, and has been, in compliance in all material respects with all applicable Laws. To the Company's Knowledge, no event has occurred and no circumstance exists that (with or without notice or lapse of time) (a) may constitute or result in a violation by any Group Company of, or a failure on the part of such entity to comply with, any applicable Laws in any material respect, or (b) may give rise to any obligation on the part of any Group Company to undertake, or to bear all or any portion of the cost of, any remedial action of any nature. None of the Group Companies has received any notice from any Governmental Authority regarding any of the foregoing. To the Knowledge of the Company, no Group Company is under investigation with respect to a material violation of any Law.

(ii) All material Consents from or with the relevant Governmental Authority required in respect of the due and proper establishment and operations of each Group Company as now conducted, including but not limited to the Consents from or with authorities, product registration authorities, and health regulatory authorities and the local counterpart thereof, as applicable (or any predecessors thereof, as applicable), have been duly obtained or completed in accordance with all applicable Laws.

(iii) None of the Group Companies is in default in any material respect under any required Governmental Consent. No Group Company has received any letter or other written communication from any Governmental Authority threatening or providing notice of revocation of any Required Governmental Consent issued to any Group Company or the need for compliance or remedial actions in respect of the activities carried out directly or indirectly by any Group Company.

### **3.9 Tax Matters.**

(i) Each Group Company (a) has timely filed all income and other material Tax Returns that are required to have been filed by it with any Governmental Authority, (b) has timely paid all Taxes owed by it which are due and payable (whether or not shown on any Tax Return), except to the extent any failure to timely pay such Taxes would not have a Material Adverse Effect.

(ii) Each Tax Return referred to in paragraph (i) above was properly prepared in compliance with applicable Law and was (and will be) true, correct and complete in all material respects. No reporting position was taken on any such Tax Return which has not been disclosed to the appropriate Tax authority or in such Tax Return, as may be required by Law. All records relating to such Tax Returns or to the preparation thereof required by applicable Law to be maintained by applicable Group Company have been duly maintained. No written claim has been made by a Governmental Authority in a jurisdiction where the Group does not file Tax Returns that any Group Company is or may be subject to taxation by that jurisdiction.

(iii) There is no pending dispute with, or notice from, any Tax authority relating to any of the Tax Returns filed by any Group Company, and to the Knowledge of the Company, there is no proposed Liability for a deficiency in any Tax to be imposed upon the properties or assets of any Group Company.

(iv) No Group Company has been the subject of any examination or investigation by any Tax authority relating to the conduct of its business or the payment or withholding of Taxes that has not been resolved or is currently the subject of any examination or investigation by any Tax authority relating to the conduct of its business or the payment or withholding of Taxes.

(v) [Intentionally Left Blank]

(vi) The Company is treated as a corporation for U.S. federal income tax purposes.

**3.10 Financial Statements.** Section 3.10 of the Disclosure Schedule sets forth the unaudited consolidated balance sheet and statements of operations for the Group as of and for the twelve-months ending December 31, 2018 (the "Annual Statement Date") and the unaudited consolidated balance sheet (the "Balance Sheet") and statements of operations for the Group as of and for the 10-month period ending October 31, 2019 (the "Statement Date") (collectively, the financial statements referred to above, the "Financial Statements"). The Financial Statements (a) have been prepared in accordance with the books and records of the Group, (b) fairly present in all material respects the financial condition and position of the Group as of the dates indicated therein and the results of operations of the Group for the periods indicated therein, except in the case of unaudited financial statements for the omission of notes thereto and normal year-end audit adjustments that are not expected to be material, and (c) were prepared in accordance with the Accounting Standards applied on a consistent basis throughout the periods involved.

**3.11 Actions.** There is no material Action pending or, to the Knowledge of the Company, threatened against or affecting any Group Company or any of its officers, directors or employees with respect to its businesses or proposed business activities, or, to the Knowledge of the Company, any officers, directors or employees of any Group Company in connection with such person's respective relationship with such Group Company. There is no judgment or award unsatisfied against any Group Company, nor is there any Governmental Order in effect and binding on any Group Company or their respective assets or properties. There is no material Action pending by any Group Company against any third party nor does any Group Company intend to commence any such Action. No Governmental Authority has at any time challenged or questioned in writing the legal right of any Group Company to conduct in any material respect its business as presently being conducted.

**3.12 Liabilities.** No Group Company has any Liabilities of the type required to be disclosed on a balance sheet except for (i) liabilities set forth in the Balance Sheet that have not been satisfied since the Statement Date, and (ii) current liabilities, including payables to vendors, incurred since the Statement Date in the ordinary course of the Group's business consistent with its past practices and which do not exceed US\$4,237,450.78 in the aggregate. Except for the Notes and as set forth in Section 3.12 of the Disclosure Schedule and except for Indebtedness incurred in the ordinary course of the Group's business consistent with its past practices, none of the Group Companies has any outstanding Indebtedness. None of the Group Companies is a guarantor or indemnitor of any Liabilities of any other Person (other than a Group Company).

**3.13 Anti-Bribery, Anti-Corruption, Anti-Money Laundering and Sanctions; Absence of Government Interests.**

(i) Each Group Company and to the Knowledge of the Company, their respective directors, officers, employees, agents and other persons acting on their behalf (collectively, “Representatives”) are and have been in material compliance with all applicable Laws relating to anti-bribery, anti-corruption, anti-money laundering, record keeping and internal control laws (collectively, the “Compliance Laws”) including the FCPA as if it were a U.S. Person. Furthermore, no Public Official (i) holds an ownership or other economic interest, direct or indirect, in any of the Group Companies or in the contractual relationship formed by this Agreement, or (ii) serves as an officer, director or employee of any Group Company. To the Knowledge of the Company, neither any Group Company nor any Representative has, directly or indirectly, offered, authorized, promised, condoned, participated in, consummated, or received notice of any allegation of,

(a) the making of any gift or payment of anything of value to any Public Official by any Person to obtain any improper advantage, affect or influence any act or decision of any such Public Official, or assist any Group Company in obtaining or retaining business for, or with, or directing business to, any Person.

(b) the taking of any action by any Person which (i) would violate the FCPA, if taken by an entity subject to the FCPA, or (ii) could reasonably be expected to constitute a violation of any applicable Compliance Law, or

(c) the making of any false or fictitious entries in the books or records of any Group Company by any Person, or

(d) the using of any assets of any Group Company for the establishment of any unlawful or unrecorded fund of monies or other assets, or the making of any unlawful or undisclosed payment.

(ii) No Group Company or any of its Representatives has ever been found by a Governmental Authority to have violated any criminal or securities Law or is subject to any indictment or any government investigation for bribery. None of the beneficial owners of any Equity Securities or other interest in any Group Company or the current or former Representatives of any Group Company are or were Public Officials.

(iii) No Group Company or any of its Representatives is a Prohibited Person, and no Prohibited Person will be given an offer to become an employee, officer, consultant or director of any Group Company. No Group Company has conducted or agreed to conduct any business, or entered into or agreed to enter into any transaction with a Prohibited Person.

(iv) If the Group Companies have beneficial owners or Representatives who are Public Officials, to the Knowledge of the Company, no such Public Official has been involved on behalf of a Governmental Authority in decisions as to whether any Group Company or the Investors or the Note Holders would be awarded business or that otherwise could benefit any Group Company or the Investors or the Note Holders, or in the appointment, promotion, or compensation of persons who will make such decisions.

**3.14 Related Party Transactions.** Other than as set forth in Section 3.14 of the Disclosure Schedule, no Related Party has any Contract with, or is indebted to, any Group Company or has any direct or indirect interest in any Group Company (other than as set forth in Section 3.2(i) of the Disclosure Schedule), nor is any Group Company indebted (or committed to make loans or extend or guarantee credit) to any Related Party (other than for accrued salaries for the current pay period, reimbursable expenses or other standard employee benefits). No Related Party has any direct or indirect interest in any Person with which a Group Company is affiliated or with which a Group Company has a material business relationship (including any Person which purchases from or sells, licenses or furnishes to a Group Company any goods, intellectual or other property rights or services) or in any Contract to which a Group Company is a party or by which it may be bound or affected, and no Related Party directly or indirectly competes with or has any interest in any Person that directly or indirectly competes with any Group Company (other than ownership of less than one percent (1%) of the stock of publicly traded companies), in each case except for as specifically disclosed in Section 3.14 of the Disclosure Schedule.

**3.15 Intellectual Property Rights.**

(i) **Company IP.** Each Group Company owns or otherwise has sufficient rights (including but not limited to the rights of development, maintenance, licensing and sale) to all Intellectual Property necessary and sufficient to conduct its Business ("Company IP") without any conflict with or infringement of the rights of any other Person. Section 3.15(i) of the Disclosure Schedule sets forth a complete and accurate list of all Company Registered IP for each Group Company.

(ii) **IP Ownership.** All Company Registered IP is owned by a Group Company, is valid and subsisting and has not been abandoned, and all necessary registration, maintenance and renewal fees with respect thereto and currently due have been satisfied. To the Knowledge of the Company, no Group Company or any of its employees, officers or directors has taken any actions or failed to take any actions that would cause any Company Owned IP to be invalid, unenforceable or not subsisting. No Group Company is or has been a member or promoter of, or contributor to, any industry standards bodies, patent pooling organizations or similar organizations that could require or obligate a Group Company to grant or offer to any Person any license or right to any material Company Owned IP. No Company Owned IP is subject to any proceeding or outstanding Governmental Order or settlement agreement or stipulation that (a) restricts in any manner the use, transfer or licensing thereof, or the making, using, sale, or offering for sale of any Group Company's products or services, by any Group Company or (b) may affect the validity, use or enforceability of such Company Owned IP. No Group Company has (a) transferred or assigned any material Company Owned IP to any other Person; (b) authorized the joint ownership of other Person in any material Company Owned IP; or (c) permitted the rights of any Group Company in any material Company Owned IP to lapse or enter into the public domain.

(iii) **Infringement, Misappropriation and Claims.** To the Knowledge of the Company, no Group Company has misappropriated, or to the Knowledge of the Company, violated, or infringed in any material respect any Intellectual Property of any other Person, nor has any Group Company received any written notice alleging any of the foregoing. To the Knowledge of the Company, no Person has violated, infringed or misappropriated any material Company Owned IP of any Group Company, and no Group Company has given any written notice to any other Person alleging any of the foregoing. To the Knowledge of the Company, no Person has challenged the ownership or use of any material Company IP by a Group Company. No Group Company has agreed to indemnify any Person for any infringement, violation or misappropriation of any Intellectual Property by such Person.

(iv) **Assignments and Prior IP.** All material inventions and material know-how conceived by employees of a Group Company related to the Business of such Group Company are currently owned exclusively by a Group Company. All employees, contractors, agents and consultants of a Group Company who are or were involved in the creation of any material Intellectual Property for such Group Company have executed an assignment of inventions agreement that vests in a Group Company exclusive ownership of all right, title and interest in and to such Intellectual Property, to the extent not already provided by Law. All employee inventors of Company Owned IP have received reasonable reward and remunerations from a Group Company for his/her service inventions or service technology achievements in accordance with the applicable laws. To the Knowledge of the Company, it will not be necessary to utilize any Intellectual Property of any such Persons made prior to their employment by a Group Company, except for those that are exclusively owned by a Group Company, and none of such Intellectual Property has been utilized by any Group Company. To the Knowledge of the Company, none of the employees, consultants or independent contractors, currently or previously employed or otherwise engaged by any Group Company, (a) is in violation of any current or prior confidentiality, non-competition or non-solicitation obligations to such Group Company or to any other Persons, including former employers, or (b) is obligated under any Contract, or subject to any Governmental Order, that would interfere with the use of his or her best efforts to promote the interests of the Group Companies or that would conflict with the business of such Group Company as presently conducted.

(v) **Licenses.** Section 3.15(y) of the Disclosure Schedule contains a complete and accurate list of the following (collectively, the “Licenses”): (a) all licenses, sublicenses, and other Contracts to which any Group Company is a party and pursuant to which any third party is authorized to use, exercise or receive any benefit from any material Company IP, and (b) all licenses, sublicenses and other Contracts to which any Group Company is a party and pursuant to which such Group Company is authorized to use, exercise, or receive any benefit from any material Intellectual Property of another Person, in each case except for (1) agreements involving “off-the-shelf” commercially available software, and (2) non-exclusive licenses to customers of the Business in the ordinary course of business consistent with past practice.

(vi) **Protection of IP.** Each Group Company has taken reasonable and appropriate steps to protect, maintain and safeguard material Company Owned IP and made all applicable filings, registrations and payments of fees in connection with the foregoing. Without limiting the foregoing, to the Knowledge of the Company, all current and former officers, employees, consultants and independent contractors of any Group Company and all suppliers, customers, distributors, and other third parties having access to any material Company IP have executed and delivered to such Group Company an agreement requiring the protection of such Company IP. To the extent that any material Company IP has been developed or created independently or jointly by an independent contractor or other third party for any Group Company, or is incorporated into any products or services of any Group Company, such Group Company has a written agreement with such independent contractor or third party and has thereby obtained ownership of, and is the exclusive owner of all such independent contractor's or third party's Intellectual Property in such work, material or invention by operation of law or valid assignment.

**3.16 Labor and Employment Matters.**

(i) Each Group Company has complied in all material respects with all applicable Laws related to labor or employment, including provisions thereof relating to wages, hours, working conditions, benefits, retirement, social welfare, equal opportunity and collective bargaining. There is not pending or to the Knowledge of the Company threatened, and there has not been in the last three (3) years, any Action relating to the violation or alleged violation of any applicable Laws by any Group Company related to labor or employment, including any charge or complaint filed by an employee with any Governmental Authority or any Group Company.

(ii) Section 3.16(ii) of the Disclosure Schedule contains a true and complete list of each Benefit Plan currently or previously adopted, maintained, or contributed to by any Group Company or under which any Group Company has any Liability or under which any employee or former employee of any Group Company has any present or future right to benefits.

**3.17 Entire Business.** No Group Company provides any facilities, operational services, assets or properties to any other entity which is not a Group Company.

**3.18** [Intentionally Left Blank]

**4. Representations and Warranties of the Investors.** Each Investor hereby represents and warrants to the Company, severally and not jointly, that:

**4.1 Authorization.** Such Investor has all requisite power and authority to execute and deliver the Transaction Documents to which it is a party and to carry out and perform its obligations thereunder. All action on the part of such Investor (and, as applicable, its officers, directors and shareholders) necessary for the authorization, execution and delivery of the Transaction Documents to which it is a party, and the performance of all obligations of such Investor thereunder, has been taken or will be taken prior to or at the Closing, as applicable. Each Transaction Document that has been duly executed and delivered by such Investor (to the extent such Investor is a party), constitutes valid and legally binding obligations of such Investor, enforceable against such Investor in accordance with its terms, except (i) as limited by applicable bankruptcy, insolvency, reorganization, moratorium, and other Laws of general application affecting enforcement of creditors' rights generally, and (ii) as limited by Laws relating to the availability of specific performance, injunctive relief, or other equitable remedies.

**4.2 Purchase for Own Account.** The Shares and the Conversion Shares will be acquired for such Investor's own account, not as a nominee or agent, and not with a view to or in connection with the sale or distribution of any part thereof, and that the Purchaser has no present intention of selling, granting any participation in, or otherwise distributing the same. By executing this Agreement, the Investor further represents that the Investor does not presently have any contract, undertaking, agreement or arrangement with any Person to sell, transfer or grant participations to such Person or to any third Person, with respect to any of the Shares and the Conversion Shares. The Investor has not been formed for the specific purpose of acquiring the Shares and the Conversion Shares.

**4.3 Status of Investor.** Such Investor is either (i) an "accredited investor" within the meaning of Securities and Exchange Commission ("SEC") Rule 501 of Regulation D, as presently in effect, under the Securities Act, or (ii) not a "U.S. person" as defined in Rule 902 of Regulation S of the Securities Act. Such Investor has the knowledge, sophistication and experience necessary to make an investment decision like that involved in the purchase of the applicable Shares and can bear the economic risk of its investment in the Shares. Such Investor represents that by reason of its, or of its management's, business or financial experience, such Investor has the capacity to protect its own interests in connection with the transactions contemplated in the Transaction Documents. Further, such Investor is aware of no publication of any advertisement in connection with the transactions contemplated in the Agreement.

**4.4 Disclosure of Information.** Such Investor has had an opportunity to discuss the Company's business, management and financial affairs with directors, officers and management of the Company and has had the opportunity to review the Company's operations and facilities. Such Investor has also had the opportunity to ask questions of and receive answers from, the Company and its management regarding the terms and conditions of this investment.

**4.5 Restricted Securities.** Such Investor understands that the Shares and the Conversion Shares are restricted securities within the meaning of Rule 144 under the Securities Act; and that the Shares and the Conversion Shares are not registered or listed publicly and must be held indefinitely unless they are subsequently registered or listed publicly or an exemption from such registration or listing is available. Such Investor understands that the Company has no present intention of registering the Shares or the Conversion Shares. Such Investor also understands that there is no assurance that any exemption from registration under the Securities Act will be available and that, even if available, such exemption may not allow the Investor to transfer all or any portion of the Shares or the Conversion Shares under the circumstances, in the amounts or at the times the Investor might propose.

**4.6 No Brokers.** Neither such Investor nor any of its Affiliates has any Contract with any broker, finder or similar agent with respect to the transactions contemplated by this Agreement or by any of the Transaction Documents, and none of them has incurred any Liability for any brokerage fees, agents' fees, commissions or finders' fees in connection with any of the Transaction Documents or the consummation of the transactions contemplated therein.



**4.7 Legends.** Such Investor understands that the Shares and the Conversion Shares, may be notated with one or all of the following legends:

(i) "THE SHARES REPRESENTED HEREBY HAVE NOT BEEN REGISTERED UNDER THE SECURITIES ACT OF 1933, AND HAVE BEEN ACQUIRED FOR INVESTMENT AND NOT WITH A VIEW TO, OR IN CONNECTION WITH, THE SALE OR DISTRIBUTION THEREOF. NO SUCH TRANSFER MAY BE EFFECTED WITHOUT AN EFFECTIVE REGISTRATION STATEMENT RELATED THERETO OR AN OPINION OF COUNSEL IN A FORM SATISFACTORY TO THE COMPANY THAT SUCH REGISTRATION IS NOT REQUIRED UNDER THE SECURITIES ACT OF 1933."

(ii) Any legend set forth in, or required by, the other Transaction Agreements.

(iii) Any legend required by the securities laws of any state to the extent such laws are applicable to the Shares and the Conversion Shares represented by the certificate, instrument, or book entry so legended.

**4.8 No General Solicitation.** Neither the Investor, nor any of its officers, directors, employees, agents, stockholders or partners has either directly or indirectly, including, through a broker or finder (a) engaged in any general solicitation, or (b) published any advertisement in connection with the offer and sale of the Shares.

**4.10 Residence.** If the Investor is an individual, then the Investor resides in the state or province identified in the address of Investor set forth on Schedule III; if the Investor is a partnership, corporation, limited liability company or other entity, then the office or offices of Investor in which its investment decision was made is located at the address or addresses of the Investor set forth on Schedule III.

**4.11 Transfer Restrictions.** Each Investor acknowledges and agrees that the Shares and, if issued, the Conversion Shares are subject to restrictions on transfer as set forth in the Shareholders Agreement.

**5. Representations and Warranties of the Note Holders.** Each Note Holder hereby represents and warrants to the Company, severally and not jointly, that:

**5.1 Authorization.** Such Note Holder has all requisite power and authority to execute and deliver the Transaction Documents to which it is a party and to carry out and perform its obligations thereunder. All action on the part of such Note Holder (and, as applicable, its officers, directors and shareholders) necessary for the authorization, execution and delivery of the Transaction Documents to which it is a party, and the performance of all obligations of such Note Holder thereunder, has been taken or will be taken prior to or at the Closing, as applicable. Each Transaction Document that has been duly executed and delivered by such Note Holder (to the extent such Note Holder is a party), constitutes valid and legally binding obligations of such Note Holder, enforceable against such Note Holder in accordance with its terms, except (i) as limited by applicable bankruptcy, insolvency, reorganization, moratorium, and other Laws of general application affecting enforcement of creditors' rights generally, and (ii) as limited by Laws relating to the availability of specific performance, injunctive relief, or other equitable remedies.

**5.2 Purchase for Own Account.** The Shares and the Conversion Shares will be acquired for such Note Holder 's own account, not as a nominee or agent, and not with a view to or in connection with the sale or distribution of any part thereof, and that the Purchaser has no present intention of selling, granting any participation in, or otherwise distributing the same. By executing this Agreement, the Note Holder further represents that the Note Holder does not presently have any contract, undertaking, agreement or arrangement with any Person to sell, transfer or grant participations to such Person or to any third Person, with respect to any of the Shares and the Conversion Shares. The Note Holder has not been formed for the specific purpose of acquiring the Shares and the Conversion Shares.

**5.3 Status of Note Holder.** Such Note Holder is either (i) an "accredited investor" within the meaning of Securities and Exchange Commission ("SEC") Rule 501 of Regulation D, as presently in effect, under the Securities Act, or (ii) not a "U.S. person" as defined in Rule 902 of Regulation S of the Securities Act. Such Note Holder has the knowledge, sophistication and experience necessary to make an investment decision like that involved in the purchase of the applicable Shares and can bear the economic risk of its investment in the Shares. Such Note Holder represents that by reason of its, or of its management's, business or financial experience, such Note Holder has the capacity to protect its own interests in connection with the transactions contemplated in the Transaction Documents. Further, such Note Holder is aware of no publication of any advertisement in connection with the transactions contemplated in the Agreement.

**5.4 Disclosure of Information.** Such Note Holder has had an opportunity to discuss the Company's business, management and financial affairs with directors, officers and management of the Company and has had the opportunity to review the Company's operations and facilities. Such Note Holder has also had the opportunity to ask questions of and receive answers from, the Company and its management regarding the terms and conditions of this investment.

**5.5 Restricted Securities.** Such Note Holder understands that the Shares and the Conversion Shares are restricted securities within the meaning of Rule 144 under the Securities Act; and that the Shares and the Conversion Shares are not registered or listed publicly and must be held indefinitely unless they are subsequently registered or listed publicly or an exemption from such registration or listing is available. Such Note Holder understands that the Company has no present intention of registering the Shares or the Conversion Shares. Such Note Holder also understands that there is no assurance that any exemption from registration under the Securities Act will be available and that, even if available, such exemption may not allow the Note Holder to transfer all or any portion of the Shares or the Conversion Shares under the circumstances, in the amounts or at the times the Note Holder might propose.

**5.6 No Brokers.** Neither such Note Holder nor any of its Affiliates has any Contract with any broker, finder or similar agent with respect to the transactions contemplated by this Agreement or by any of the Transaction Documents, and none of them has incurred any Liability for any brokerage fees, agents' fees, commissions or finders' fees in connection with any of the Transaction Documents or the consummation of the transactions contemplated therein.

**5.7 Legends.** Such Note Holder understands that the Shares and the Conversion Shares, may be notated with one or all of the following legends:

(i) "THE SHARES REPRESENTED HEREBY HAVE NOT BEEN REGISTERED UNDER THE SECURITIES ACT OF 1933, AND HAVE BEEN ACQUIRED FOR INVESTMENT AND NOT WITH A VIEW TO, OR IN CONNECTION WITH, THE SALE OR DISTRIBUTION THEREOF. NO SUCH TRANSFER MAY BE EFFECTED WITHOUT AN EFFECTIVE REGISTRATION STATEMENT RELATED THERETO OR AN OPINION OF COUNSEL IN A FORM SATISFACTORY TO THE COMPANY THAT SUCH REGISTRATION IS NOT REQUIRED UNDER THE SECURITIES ACT OF 1933."

(ii) Any legend set forth in, or required by, the other Transaction Agreements.

(iii) Any legend required by the securities laws of any state to the extent such laws are applicable to the Shares and the Conversion Shares represented by the certificate, instrument, or book entry so legended.

**5.8 No General Solicitation.** Neither the Note Holder, nor any of its officers, directors, employees, agents, stockholders or partners has either directly or indirectly, including, through a broker or finder (a) engaged in any general solicitation, or (b) published any advertisement in connection with the offer and sale of the Shares.

**5.10 Residence.** If the Note Holder is an individual, then the Note Holder resides in the state or province identified in the address of Note Holder set forth on Schedule III; if the Note Holder is a partnership, corporation, limited liability company or other entity, then the office or offices of Note Holder in which its investment decision was made is located at the address or addresses of the Note Holder set forth on Schedule III.

**5.11 Transfer Restrictions.** Each Note Holder acknowledges and agrees that the Shares and, if issued, the Conversion Shares are subject to restrictions on transfer as set forth in the Shareholders Agreement.

**5.12 Consent to Promissory Note Conversion and Termination.** Each Note Holder, hereby agrees that the entire amount owed to such Note Holder under such note is being tendered to the Company in exchange for the applicable Shares set forth on the Schedule of Note Holders, and effective upon the Company's and such Note Holder's execution and delivery of this Agreement, without any further action required by the Company or such Note Holder, such note and all obligations set forth therein shall be immediately deemed repaid in full and terminated in their entirety, including, but not limited to, any security interest effected therein.

**6. Conditions of the Investors' and Note Holders' Obligations at the Closing.** The obligations of each Investor and the Note Holders to consummate the Closing under Section 2 of this Agreement are subject to the fulfillment, to the satisfaction of such Investor or such Note Holder on or prior to the Closing, or waiver by such Investor or such Note Holders, of the following conditions:

**6.1 Representations and Warranties.** Each of the representations and warranties of the Company contained in Section 3 shall have been true and complete when made and shall be true and complete in all material respects on and as of the Closing with the same effect as though such representations and warranties had been made on and as of the date of such Closing, except in either case for those representations and warranties that address matters only as of a particular date, which representations will have been true and complete as of such particular date.

**6.2 Performance.** The Company shall have performed and complied with all obligations and conditions contained in the Transaction Documents that are required to be performed or complied with by them on or before the Closing.

**6.3 Authorizations.** All Consents of any competent Governmental Authority or of any other Person that are required to be obtained by the Company in connection with the consummation of the transactions contemplated by the Transaction Documents (including but not limited to those related to the lawful issuance and sale of the Shares, and any waivers of notice requirements, rights of first refusal, preemptive rights, put or call rights), including necessary board and shareholder approvals of the Company, shall have been duly obtained and effective as of the Closing, and evidence thereof shall have been delivered to the Investors and the Note Holders as it may reasonably request.

**6.4 Proceedings and Documents.** All corporate and other proceedings in connection with the transactions to be completed at the Closing and all documents incident thereto with respect to this Agreement and the other Transaction Documents and the transactions contemplated hereby and thereby, shall have been completed in form and substance reasonably satisfactory to the Investors and Note Holders, and each Investor and Note Holder shall have received all such counterpart original or other copies of such documents as it may reasonably request.

**6.5 Memorandum and Articles.** The Memorandum and Articles, in the forms attached hereto as Exhibit A-1 and Exhibit A-2, respectively, shall have been duly adopted by all necessary action of the Board of Directors and/or the members of the Company, and such adoption shall have become effective prior to the Closing with no alternation or amendment as of the Closing.

**6.6 Transaction Documents.** Each of the parties to the Transaction Documents, other than the Investors and the Note Holders, shall have executed and delivered such Transaction Documents to the Investors and the Note Holders.

**6.7** [Intentionally Left Blank]

7. **Conditions of the Company's Obligations at Closing.** The obligations of the Company owed to each Investor and each Note Holder to consummate the Closing under Section 2 of this Agreement, unless otherwise waived in writing by the Company, are subject to the fulfillment on or before the Closing of each of the following conditions:

7.1 **Representations and Warranties.** The representations and warranties of such Investor contained in Section 4 and 5 shall have been true and complete when made and shall be true and complete on and as of the Closing with the same effect as though such representations and warranties had been made on and as of the date of the Closing, except in either case for those representations and warranties that address matters only as of a particular date, which representations will have been true and complete as of such particular date.

7.2 **Performance.** Such Investor shall have performed and complied with all covenants, obligations and conditions contained in this Agreement that are required to be performed or complied with by such Investor on or before the Closing.

7.3 **Execution of Transaction Documents.** Such Investor shall have executed and delivered to the Company the Transaction Documents, to which such Investor is a party.

7.4 **Surrender of Notes.** Each Note Holder shall have surrendered all Notes held by such Note Holder, or lost note affidavits, to the Company for cancellation.

8. **Other Agreements.**

8.1 **Confidentiality.** The terms and conditions of the Transaction Documents (collectively, the "**Financing Terms**"), including their existence, shall be considered confidential information and shall not be disclosed by any of the Parties to any other Person except that (i) each Party, as appropriate, may disclose any of the Financing Terms to its current or bona fide prospective investors, employees, investment bankers, lenders, accountants and attorneys, in each case only where such Persons are under appropriate nondisclosure obligations; (ii) each Investor may disclose any of the Financing Terms to its fund manager and the employees thereof so long as such Persons are under appropriate nondisclosure obligations; and (iii) if any Party is requested or becomes legally compelled (including without limitation, pursuant to securities Laws) to disclose the existence or content of any of the Financing Terms in contravention of the provisions of this Section, such Party shall promptly provide the other Parties with written notice of that fact so that such other Parties may seek a protective order, confidential treatment or other appropriate remedy and in any event shall furnish only that portion of the information that is legally required and shall exercise reasonable efforts to obtain reliable assurance that confidential treatment will be accorded such information.

9. **Miscellaneous.**

9.1 **Further Assurances.** Upon the terms and subject to the conditions herein, each of the Parties hereto agrees to use its reasonable best efforts to take or cause to be taken all action, to do or cause to be done, to execute such further instruments, and to assist and cooperate with the other Parties hereto in doing, all things necessary, proper or advisable under applicable Laws or otherwise to consummate and make effective, in the most expeditious manner practicable, the transactions contemplated by this Agreement and the other Transaction Documents (it being understood that no Party shall be obligated to grant any waiver of any condition or other waiver hereunder).

**9.2 Successors and Assigns.** Except as otherwise provided herein, the terms and conditions of this Agreement shall inure to the benefit of and be binding upon the respective successors and assigns of the Parties hereto whose rights or obligations hereunder are affected by such terms and conditions. This Agreement and the rights and obligations therein may not be assigned by the Company without the prior written consent of the Investors. Nothing in this Agreement, express or implied, is intended to confer upon any Party other than the Parties hereto or their respective successors and assigns any rights, remedies, obligations, or liabilities under or by reason of this Agreement, except as expressly provided in this Agreement.

**9.3 Governing Law.** This Agreement shall be governed by and construed under the Laws of Hong Kong, without regard to principles of conflict of Laws thereunder.

**9.4 Dispute Resolution.**

(i) Any dispute, controversy or claim (each, a “Dispute”) arising out of or relating to this Agreement, or the interpretation, breach, termination, validity or invalidity thereof, shall be referred to arbitration upon the demand of either party to the dispute with notice (the “Arbitration Notice”) to the other.

(ii) The Dispute shall be settled by arbitration in Hong Kong by the Hong Kong International Arbitration Centre (the “HKIAC”) in accordance with the Hong Kong International Arbitration Centre Administered Arbitration Rules (the “HKIAC Rules”) in force when the Arbitration Notice is submitted in accordance with the HKIAC Rules. There shall be one (1) arbitrator. The HKIAC Council shall select the arbitrator, who shall be qualified to practice law in Hong Kong.

(iii) The arbitral proceedings shall be conducted in English. To the extent that the HKIAC Rules are in conflict with the provisions of this Section, including the provisions concerning the appointment of the arbitrators, the provisions of this Section shall prevail.

(iv) Each party to the arbitration shall cooperate with each other party to the arbitration in making full disclosure of and providing complete access to all information and documents requested by such other party in connection with such arbitral proceedings, subject only to any confidentiality obligations binding on such party.

(v) The award of the arbitral tribunal shall be final and binding upon the parties thereto, and the prevailing party may apply to a court of competent jurisdiction for enforcement of such award.

(vi) The arbitral tribunal shall decide any Dispute submitted by the parties to the arbitration strictly in accordance with the substantive Laws of Hong Kong (without regard to principles of conflict of Laws thereunder) and shall not apply any other substantive Law.

(vii) Any party to the Dispute shall be entitled to seek preliminary injunctive relief, if possible, from any court of competent jurisdiction pending the constitution of the arbitral tribunal.

(viii) During the course of the arbitral tribunal's adjudication of the Dispute, this Agreement shall continue to be performed except with respect to the part in dispute and under adjudication.

**9.5 Notices.** Any notice required or permitted pursuant to this Agreement shall be given in writing and shall be given either personally or by sending it by next-day or second-day courier service, fax, electronic mail or similar means to the address of the relevant Party as shown on Schedule III (or at such other address as such Party may designate by fifteen (15) days' advance written notice to the other Parties to this Agreement given in accordance with this Section). Where a notice is sent by next-day or second-day courier service, service of the notice shall be deemed to be effected by properly addressing, pre-paying and sending by next-day or second-day service through an internationally-recognized courier a letter containing the notice, with a written confirmation of delivery, and to have been effected at the earlier of (i) delivery (or when delivery is refused) and (ii) expiration of two (2) Business Days after the letter containing the same is sent as aforesaid. Where a notice is sent by fax or electronic mail, service of the notice shall be deemed to be effected by properly addressing, and sending such notice through a transmitting organization, with a written confirmation of delivery, and to have been effected on the day the same is sent as aforesaid, if such day is a Business Day and if sent during normal business hours of the recipient, otherwise the next Business Day. Notwithstanding the foregoing, to the extent a "with a copy to" address is designated, notice must also be given to such address in the manner above for such notice, request, consent or other communication hereunder to be effective.

**9.6 Rights Cumulative; Specific Performance.** Each and all of the various rights, powers and remedies of a party hereto will be considered to be cumulative with and in addition to any other rights, powers and remedies which such Party may have at Law or in equity in the event of the breach of any of the terms of this Agreement. The exercise or partial exercise of any right, power or remedy will neither constitute the exclusive election thereof nor the waiver of any other right, power or remedy available to such Party. Without limiting the foregoing, the Parties hereto acknowledge and agree irreparable harm may occur for which money damages would not be an adequate remedy in the event that any of the provisions of this Agreement were not performed in accordance with their specific terms or were otherwise breached. It is accordingly agreed that the Parties shall be entitled to injunction to prevent breaches of this Agreement and to enforce specifically the terms and provisions of this Agreement.

**9.7 Fees and Expenses.** Each of the parties hereto shall bear its own costs and expenses in connection with the negotiation, execution, delivery and performance of this Agreement and the other Transaction Documents and the transactions contemplated hereby and thereby. If any action at Law or in equity is necessary to enforce or interpret the terms of this Agreement, the prevailing party shall be entitled to reasonable attorney's fees, costs and necessary disbursements in addition to any other relief to which such party may be entitled.

**9.8** [Intentionally Left Blank]

**9.9 Severability.** In case any provision of the Agreement shall be invalid, illegal or unenforceable, the validity, legality and enforceability of the remaining provisions shall not in any way be affected or impaired thereby. If, however, any provision of this Agreement shall be invalid, illegal, or unenforceable under any such applicable Law in any jurisdiction, it shall, as to such jurisdiction, be deemed modified to conform to the minimum requirements of such Law, or, if for any reason it is not deemed so modified, it shall be invalid, illegal, or unenforceable only to the extent of such invalidity, illegality, or limitation on enforceability without affecting the remaining provisions of this Agreement, or the validity, legality, or enforceability of such provision in any other jurisdiction.

**9.10 Amendments and Waivers.** Any term of this Agreement may be amended, only with the written consent of each of (i) the Company, and (ii) the Investors and the Note Holders that shall hold at least a majority of Shares immediately after the Closing. Any amendment effected in accordance with this paragraph shall be binding upon each of the Parties hereto. Notwithstanding the foregoing, the observance of any term of this Agreement may be waived (either generally or in a particular instance and either retroactively or prospectively) only with the written consent of the Party against whom such waiver is sought.

**9.11 No Waiver.** Failure to insist upon strict compliance with any of the terms, covenants, or conditions hereof will not be deemed a waiver of such term, covenant, or condition, nor will any waiver or relinquishment of, or failure to insist upon strict compliance with, any right, power or remedy power hereunder at any one or more times be deemed a waiver or relinquishment of such right, power or remedy at any other time or times.

**9.12 Delays or Omissions.** No delay or omission to exercise any right, power or remedy accruing to any Party under this Agreement, upon any breach or default of any other Party under this Agreement, shall impair any such right, power or remedy of such non-breaching or non-defaulting Party nor shall it be construed to be a waiver of any such breach or default, or an acquiescence therein, or of or in any similar breach or default thereafter occurring; nor shall any waiver of any single breach or default be deemed a waiver of any other breach or default theretofore or thereafter occurring. Any waiver, permit, consent or approval of any kind or character on the part of any Party of any breach or default under this Agreement, or any waiver on the part of any Party of any provisions or conditions of this Agreement, must be in writing and shall be effective only to the extent specifically set forth in such writing.

**9.13 No Presumption.** The Parties acknowledge that any applicable Law that would require interpretation of any claimed ambiguities in this Agreement against the Party that drafted it has no application and is expressly waived. If any claim is made by a Party relating to any conflict, omission or ambiguity in the provisions of this Agreement, no presumption or burden of proof or persuasion will be implied because this Agreement was prepared by or at the request of any Party or its counsel.



**9.14 Headings and Subtitles; Interpretation.** The titles and subtitles used in this Agreement are used for convenience only and are not to be considered in construing or interpreting this Agreement. Unless a provision hereof expressly provides otherwise: (i) the term “or” is not exclusive; (ii) words in the singular include the plural, and words in the plural include the singular; (iii) the terms “herein”, “hereof”, and other similar words refer to this Agreement as a whole and not to any particular section, subsection, paragraph, clause, or other subdivision; (iv) the term “including” will be deemed to be followed by, “but not limited to”; (v) the masculine, feminine, and neuter genders will each be deemed to include the others; (vi) the terms “shall”, “will”, and “agrees” are mandatory, and the term “may” is permissive; (vii) the term “day” means “calendar day”, and “month” means calendar month, (viii) all references in this Agreement to designated “Sections” and other subdivisions are to the designated Sections and other subdivisions of the body of this Agreement, (ix) all references in this Agreement to designated Schedules, Exhibits and Appendices are to the Schedules, Exhibits and Appendices attached to this Agreement, (x) the phrase “directly or indirectly” means directly, or indirectly through one or more intermediate Persons or through contractual or other arrangements, and “direct or indirect” has the correlative meaning, (xi) references to laws include any such law modifying, re enacting, extending or made pursuant to the same or which is modified, re enacted, or extended by the same or pursuant to which the same is made, (xii) all accounting terms not otherwise defined herein have the meanings assigned under the Accounting Standards, (xiii) pronouns of either gender or neuter shall include, as appropriate, the other pronoun forms, (xiv) references to this Agreement, any other Transaction Documents and any other document shall be construed as references to such document as the same may be amended, supplemented or novated from time to time, and (xv) all references to dollars or to “US\$” are to currency of the United States of America and all references to RMB are to currency of the PRC (and each shall be deemed to include reference to the equivalent amount in other currencies).

**9.15 Counterparts.** This Agreement may be executed in two or more counterparts, each of which shall be deemed an original, but all of which together shall constitute one and the same instrument. Facsimile and e-mailed copies of signatures shall be deemed to be originals for purposes of the effectiveness of this Agreement.

**9.16 Entire Agreement.** This Agreement and the Transaction Documents, together with all schedules and exhibits hereto and thereto, constitute the full and entire understanding and agreement among the Parties with regard to the subjects hereof and thereof, and supersede all other agreements between or among any of the Parties with respect to the subject matters hereof and thereof.

**9.17 Use of English Language.** This Agreement has been executed and delivered in the English language. Any translation of this Agreement into another language shall have no interpretive effect.

*[The remainder of this page has been left intentionally blank]*

IN WITNESS WHEREOF, the parties hereto have caused their respective duly authorized representatives to execute this Agreement on the date and year first above written.

COMPANY:

Belite Bio, Inc

By: /s/ Tom Lin

Name: Tom Lin

Title: Director

---

[Share Purchase Agreement]

IN WITNESS WHEREOF, the parties hereto have caused their respective duly authorized representatives to execute this Agreement on the date and year first above written.

INVESTORS:

By: /s/ Cheng-Chao Sung  
Name: Cheng-Chao Sung  
ID: #####

---

[Share Purchase Agreement]

IN WITNESS WHEREOF, the parties hereto have caused their respective duly authorized representatives to execute this Agreement on the date and year first above written.

INVESTORS:

By: /s/ Sen-Tai Chen

Name: Sen-Tai Chen

ID: #####

---

[Share Purchase Agreement]

IN WITNESS WHEREOF, the parties hereto have caused their respective duly authorized representatives to execute this Agreement on the date and year first above written.

INVESTORS:

By: /s/ Tzu-An Chang  
Name: Tzu-An Chang  
ID: #####

---

[Share Purchase Agreement]

IN WITNESS WHEREOF, the parties hereto have caused their respective duly authorized representatives to execute this Agreement on the date and year first above written.

INVESTORS and NOTE HOLDERS:

By: /s/ Yun-Ju Huang  
Name: Yun-Ju Huang  
ID: #####

---

[Share Purchase Agreement]

IN WITNESS WHEREOF, the parties hereto have caused their respective duly authorized representatives to execute this Agreement on the date and year first above written.

INVESTORS:

By: /s/ Cheng-Han Huang

Name: Cheng-Han Huang

ID: #####

---

[Share Purchase Agreement]

IN WITNESS WHEREOF, the parties hereto have caused their respective duly authorized representatives to execute this Agreement on the date and year first above written.

INVESTORS:

By: /s/ Lijie Chen

Name: Lijie Chen

ID: #####

---

[Share Purchase Agreement]



IN WITNESS WHEREOF, the parties hereto have caused their respective duly authorized representatives to execute this Agreement on the date and year first above written.

INVESTORS:

By: /s/ Jingwen Sun

Name: Jingwen Sun

ID: #####

---

[Share Purchase Agreement]

IN WITNESS WHEREOF, the parties hereto have caused their respective duly authorized representatives to execute this Agreement on the date and year first above written.

INVESTORS:

By: /s/ Baiqing Sun

Name: Baiqing Sun

ID: #####

---

[Share Purchase Agreement]

IN WITNESS WHEREOF, the parties hereto have caused their respective duly authorized representatives to execute this Agreement on the date and year first above written.

NOTE HOLDERS:

H&D Asset Management Co., Ltd.

By: /s/ Chu, Ping-Yu

Name: Chu, Ping-Yu

Title: Legal Representative

ID: #####

---

[Share Purchase Agreement]

**SCHEDULE I**

**SCHEDULE OF NOTE HOLDERS**

---

[Share Purchase Agreement]

**SCHEDULE II**  
**SCHEDULE OF INVESTORS**

[Share Purchase Agreement]

---

**SCHEDULE III**  
**ADDRESS FOR NOTICES**

---

[Share Purchase Agreement]

**SCHEDULE IV**

**LIST OF KEY EMPLOYEES**

---

[Share Purchase Agreement]

**SCHEDULE V**  
**BANK ACCOUNT**

---

[Share Purchase Agreement]



**SCHEDULE VI**  
**DISCLOSURE SCHEDULE**

---

[Share Purchase Agreement]

**EXHIBIT A-1**

**FORM OF AMENDED AND RESTATED MEMORANDUM OF ASSOCIATION**

---

[Share Purchase Agreement]

EXHIBIT A-2

FORM OF AMENDED AND RESTATED ARTICLES OF ASSOCIATION

---

[Share Purchase Agreement]

**EXHIBIT B**  
**FORM OF SHAREHOLDERS AGREEMENT**

---

[Share Purchase Agreement]

**SERIES B PREFERRED SHARE PURCHASE AGREEMENT**

THIS SERIES B PREFERRED SHARE PURCHASE AGREEMENT (this "Agreement") is made and entered into on December 23, 2020 by and among:

1. Belite Bio, Inc, an exempted company organized under the Laws of the Cayman Islands (the "Company"), and
2. each of the Persons listed on Schedule I attached hereto (each, an "Investor" and collectively, the "Investors").

Each of the parties to this Agreement is referred to herein individually as a "Party" and collectively as the "Parties".

**RECITALS**

- A. The Company is engaged in the business of drug development (the "Business"). The Company seeks expansion capital to grow the Business and, correspondingly, seeks to secure an investment from the Investors, on the terms and conditions set forth herein.
- B. The Investors wish to invest in the Company by subscribing for Series B Preferred Shares to be issued by the Company pursuant to the terms and subject to the conditions of this Agreement, and the Company wishes to issue and sell Series B Preferred Shares to the Investors pursuant to the terms and subject to the conditions of this Agreement.
- C. The Parties desire to enter into this Agreement and make the respective representations, warranties, covenants and agreements set forth herein on the terms and conditions set forth herein.

**WITNESSETH**

NOW, THEREFORE, in consideration of the foregoing recitals, the mutual promises hereinafter set forth, and other good and valuable consideration, the receipt and sufficiency of which are hereby acknowledged, the Parties intending to be legally bound hereto hereby agree as follows:

**1. Definitions.**

- 1.1 Capitalized terms used and not otherwise defined herein shall have the meaning ascribed to them below:

"Accounting Standards" means International Financial Reporting Standards as promulgated from time to time by the International Accounting Standards Board (the "IASB") (including, without limitation, standards and interpretations approved by the IASB and International Accounting Principles issued under previous constitutions thereof), together with the IASB's pronouncements thereon from time to time, applied on a consistent basis.

---

“Action” means any charge, claim, action, complaint, petition, investigation, appeal, suit, litigation, grievance, inquiry or other proceeding, whether administrative, civil, regulatory or criminal, whether at law or in equity, or otherwise under any applicable Law, and whether or not before any mediator, arbitrator or Governmental Authority.

“Affiliate” means, with respect to a Person, any other Person that, directly or indirectly, Controls, is Controlled by or is under common Control with such Person. In the case of an Investor, the term “Affiliate” also includes (v) any Controlling shareholder of the Investor, (w) any of such shareholder’s or Investors’ general partners or limited partners, (x) the fund manager managing such shareholder or Investor (and general partners, limited partners and officers thereof) and other funds managed by such fund manager, and (y) trusts controlled by or for the benefit of any such Person referred to in (v), (w) or (x).

“Associate” means, with respect to any Person, (1) a corporation or organization (other than the Group Companies) of which such Person is an officer or partner or is, directly or indirectly, the record or beneficial owner of ten (10) percent or more of any class of Equity Securities of such corporation or organization, (2) any trust or other estate in which such Person has a substantial beneficial interest or as to which such Person serves as trustee or in a similar capacity, or (3) any relative or spouse of such Person, or any relative of such spouse.

“Benefit Plan” means any employment Contract, deferred compensation Contract, bonus plan, incentive plan, profit sharing plan, mandatory provident scheme, occupational retirement scheme, retirement Contract or other employment compensation Contract or any other plan which provides or provided benefits for any past or present employee, officer, consultant, and/or director of a Person or with respect to which contributions are or have been made on account of any past or present employee, officer, consultant, and/or director of such a Person.

“Board” or “Board of Directors” means the board of directors of the Company.

“Business Day” means any day that is not a Saturday, Sunday, legal holiday or other day on which commercial banks are required or authorized by law to be closed in the PRC, Taiwan, or the United States.

“CFC” means a controlled foreign corporation as defined in the Code.

“Charter Documents” means, with respect to a particular legal entity, the articles of incorporation, certificate of incorporation, formation or registration (including, if applicable, certificates of change of name), memorandum of association, articles of association, bylaws, articles of organization, limited liability company agreement, trust deed, trust instrument, operating agreement, joint venture agreement, business license, or similar or other constitutive, governing, or charter documents, or equivalent documents, of such entity.

“Code” means the United States Internal Revenue Code of 1986, as amended.

“Company Owned IP” means all Intellectual Property owned by, purported to be owned by, or exclusively licensed to, the Group Companies.

“Company Registered IP” means all Intellectual Property for which registrations are owned by or held in the name of, or for which applications have been made in the name of, any Group Company.

“Consent” means any consent, approval, authorization, release, waiver, permit, grant, franchise, concession, agreement, license, exemption or order of, registration, certificate, declaration or filing with, or report or notice to, any Person, including any Governmental Authority.

“Contract” means a contract, agreement, indenture, note, bond, loan, instrument, lease, mortgage, franchise, license, commitment, purchase order, and other legally binding arrangement, whether written or oral.

“Control” of a given Person means the power or authority, whether exercised or not, to direct the business, management and policies of such Person, directly or indirectly, whether through the ownership of voting securities, by Contract or otherwise; provided, that such power or authority shall conclusively be presumed to exist upon possession of beneficial ownership or power to direct the vote of more than fifty percent (50%) of the votes entitled to be cast at a meeting of the members or shareholders of such Person or power to control the composition of a majority of the board of directors of such Person. The terms “Controlled” and “Controlling” have meanings correlative to the foregoing.

“Conversion Shares” means Ordinary Shares issuable upon conversion of any Shares.

“Equity Securities” means, with respect to any Person that is a legal entity, any and all shares of capital stock, membership interests, units, profits interests, ownership interests, equity interests, registered capital, and other equity securities of such Person, and any right, warrant, option, call, commitment, conversion privilege, preemptive right or other right to acquire any of the foregoing, or security convertible into, exchangeable or exercisable for any of the foregoing.

“FCPA” means Foreign Corrupt Practices Act of the United States of America, as amended from time to time.

“Governmental Authority” means any government of any nation, federation, province or state or any other political subdivision thereof, any entity, authority or body exercising executive, legislative, judicial, regulatory or administrative functions of or pertaining to government, including any governmental authority, agency, department, board, commission or instrumentality of the PRC or any other country, or any political subdivision thereof, any court, tribunal or arbitrator, and any self-regulatory organization.

“Governmental Order” means any applicable order, ruling, decision, verdict, decree, writ, subpoena, mandate, precept, command, directive, consent, approval, award, judgment, injunction or other similar determination or finding by, before or under the supervision of any Governmental Authority.

“Group Company,” means the Company, together with its Subsidiary of any of the foregoing, and “Group” refers to all of Group Companies collectively.

“Hong Kong” means the Hong Kong Special Administrative Region of the People’s Republic of China.

“Indebtedness” of any Person means, without duplication, each of the following of such Person: (i) all indebtedness for borrowed money, (ii) all obligations issued, undertaken or assumed as the deferred purchase price of property or services (other than trade payables entered into in the ordinary course of business), (iii) all reimbursement or payment obligations with respect to letters of credit, surety bonds and other similar instruments, (iv) all obligations evidenced by notes, bonds, debentures or similar instruments, including obligations so evidenced that are incurred in connection with the acquisition of properties, assets or businesses, (v) all indebtedness created or arising under any conditional sale or other title retention agreement, or incurred as financing, in either case with respect to any property or assets acquired with the proceeds of such indebtedness (even though the rights and remedies of the seller or bank under such agreement in the event of default are limited to repossession or sale of such property), (vi) all obligations that are capitalized (including capitalized lease obligations), (vii) all obligations under banker’s acceptance, letter of credit or similar facilities, (viii) all obligations to purchase, redeem, retire, defease or otherwise acquire for value any Equity Securities of such Person, (ix) all obligations in respect of any interest rate swap, hedge or cap agreement, and (x) all guarantees issued in respect of the Indebtedness referred to in clauses (i) through (ix) above of any other Person, but only to the extent of the Indebtedness guaranteed.

“Intellectual Property,” means any and all (i) patents, patent rights and applications therefor and reissues, reexaminations, continuations, continuations-in-part, divisions, and patent term extensions thereof, (ii) inventions (whether patentable or not), discoveries, improvements, concepts, innovations and industrial models, (iii) registered and unregistered copyrights, copyright registrations and applications, mask works and registrations and applications therefor, author’s rights and works of authorship (including artwork, software, computer programs, source code, object code and executable code, firmware, development tools, files, records and data, and related documentation), (iv) URLs, web sites, web pages and any part thereof, (v) technical information, know-how, trade secrets, drawings, designs, design protocols, specifications, proprietary data, customer lists, databases, proprietary processes, technology, formulae, and algorithms and other intellectual property, (vi) trade names, trade dress, trademarks, domain names, service marks, logos, business names, and registrations and applications therefor, and (vii) the goodwill symbolized or represented by the foregoing.

“Key Employee” means all employees of the Group Companies listed on Schedule III.

“Knowledge” means, with respect to the Company, the actual knowledge of any of the Key Employees, and that knowledge which should have been acquired by each such individual after making such due inquiry and exercising such due diligence as a prudent business person would have made or exercised in the management of his or her business affairs.



“Law” or “Laws” means any and all provisions of any applicable constitution, treaty, statute, law, regulation, ordinance, code, rule, or rule of common law, any governmental approval, concession, grant, franchise, license, agreement, directive, requirement, or other governmental restriction or any similar form of decision of, or determination by, or any interpretation or administration of any of the foregoing by, any Governmental Authority, in each case as amended, and any and all applicable Governmental Orders.

“Liabilities” means, with respect to any Person, all liabilities, obligations and commitments of such Person of any nature, whether accrued, absolute, contingent or otherwise, and whether due or to become due.

“Lien” means any claim, charge, easement, encumbrance, lease, covenant, security interest, lien, option, pledge, rights of others, or restriction (whether on voting, sale, transfer, disposition or otherwise), whether imposed by Contract, understanding, law, equity or otherwise.

“Material Adverse Effect” means any (i) event, occurrence, fact, condition, change or development that has had, has, or could reasonably be expected to have, individually or together with other events, occurrences, facts, conditions, changes or developments, a material adverse effect on the business, properties, assets, employees, operations, results of operations, condition (financial or otherwise), prospects, assets or liabilities of the Group taken as a whole, (ii) material impairment of the ability of any Party (other than the Investors) to perform the material obligations of such party under any Transaction Documents, or (iii) material impairment of the validity or enforceability of this Agreement or any other Transaction Document against any Party hereto or thereto (other than the Investors).

“Memorandum and Articles” means the Second Amended and Restated Memorandum of Association of the Company and the Second Amended and Restated Articles of Association of the Company attached hereto as Exhibits A-1 and Exhibit A-2, respectively, to be adopted in accordance with applicable Law on or before the Closing.

“MOFCOM” means the Ministry of Commerce of the PRC or, with respect to any matter to be submitted for examination and approval by the Ministry of Commerce, any Governmental Authority which is delegated or authorized by the Ministry of Commerce to examine and approve such matter under the laws of the PRC.

“Ordinary Shares” means the Company’s ordinary shares, par value US\$0.0001 per share.

“Permitted Liens” means (i) Liens for Taxes not yet delinquent or the validity of which are being contested in good faith and for which there are adequate reserves on the applicable financial statements, and (ii) Liens incurred in the ordinary course of business, which (x) do not individually or in the aggregate materially detract from the value, use, or transferability of the assets that are subject to such Liens, and (y) were not incurred in connection with the borrowing of money.

“Person” means any individual, corporation, partnership, limited partnership, proprietorship, association, limited liability company, firm, trust, estate or other enterprise or entity.

“PFIC” means a passive foreign investment company as defined in the Code.

“PRC” means the People’s Republic of China, but solely for the purposes of this Agreement and the other Transaction Documents, excluding Hong Kong, the Macau Special Administrative Region and the islands of Taiwan.

“Preferred Shares” means the Series A Preferred Shares and the Series B Preferred Shares.

“Prohibited Person” means any Person that is (1) a national or resident of any U.S. embargoed or restricted country, (2) included on, or Affiliated with any Person on, the United States Commerce Department’s Denied Parties List, Entities and Unverified Lists; the U.S. Department of Treasury’s Specially Designated Nationals, Specially Designated Narcotics Traffickers or Specially Designated Terrorists, or the Annex to Executive Order No. 13224; the Department of State’s Debarred List; UN Sanctions, (3) a member of any PRC military organization, or (4) a Person with whom business transactions, including exports and re-exports, are restricted by a U.S. Governmental Authority, including, in each clause above, any updates or revisions to the foregoing and any newly published rules.

“Public Official” means any executive, official, or employee of a Governmental Authority, political party or member of a political party, political candidate; executive, employee or officer of a public international organization; or director, officer or employee or agent of a wholly owned or partially state-owned or controlled enterprise.

“Related Party” means any Affiliate, officer, director, supervisory board member, employee, or holder of any Equity Security of any Group Company, and any Affiliate or Associate of any of the foregoing.

“SAFE” means the State Administration of Foreign Exchange of the PRC.

“SAMR” means the State Administration for Market Regulation of the PRC or, with respect to the issuance of any business license or filing or registration to be effected by or with the State Administration for Market Regulation, any Governmental Authority which is similarly competent to issue such business license or accept such filing or registration under the laws of the PRC.

“Securities Act” means the U.S. Securities Act of 1933, as amended and interpreted from time to time.

“Series A Preferred Shares” means the Series A Preferred Shares of the Company, par value US\$0.0001 per share, with the rights and privileges as set forth in the Memorandum and Articles.

“Series B Preferred Shares” means the Series B Preferred Shares of the Company, par value US\$0.0001 per share, with the rights and privileges as set forth in the Memorandum and Articles.

“Shareholders Agreement” means the Amended and Restated Shareholders Agreement to be entered into by and among the parties named therein on or prior to the Closing, which shall be in the form attached hereto as Exhibit B.

“Social Insurance” means any form of social insurance required under applicable Laws, including without limitation, the PRC national and local contributions for pensions, medical insurance, unemployment insurance, work-related injury insurance, pregnancy benefits, and housing accumulation funds.

“Subsidiary” means, with respect to any given Person, any other Person that is Controlled directly or indirectly by such given Person.

“Tax” means (i) in the PRC: (a) any national, provincial, municipal, or local taxes, charges, fees, levies, or other assessments, including, without limitation, all net income (including enterprise income tax and individual income withholding tax), turnover (including value-added tax, business tax, and consumption tax), resource (including urban and township land use tax), special purpose (including land value-added tax, urban maintenance and construction tax, and additional education fees), property (including urban real estate tax and land use fees), documentation (including stamp duty and deed tax), filing, recording, social insurance (including pension, medical, unemployment, housing, and other social insurance withholding), tariffs (including import duty and import value-added tax), and estimated and provisional taxes, charges, fees, levies, or other assessments of any kind whatsoever, (b) all interest, penalties (administrative, civil or criminal), or additional amounts imposed by any Governmental Authority in connection with any item described in clause (a) above, and (c) any form of transferee liability imposed by any Governmental Authority in connection with any item described in clauses (a) and (b) above and (ii) in any jurisdiction other than the PRC: all similar liabilities as described in clause (i)(a) and (i)(b) above.

“Tax Return” means any return, report or statement showing Taxes, used to pay Taxes, or required to be filed with respect to any Tax (including any elections, declarations, schedules or attachments thereto, and any amendment thereof), including any information return, claim for refund, amended return or declaration of estimated or provisional Tax.

“Transaction Documents” means this Agreement, the Shareholders Agreement, the Memorandum and Articles, and each of the other agreements and documents otherwise required in connection with implementing the transactions contemplated by any of the foregoing.

“U.S. real property holding corporation” has the meaning as defined in the Code.

**1.2 Other Defined Terms.** The following terms shall have the meanings defined for such terms in the Sections set forth below:

Agreement	Preamble
Arbitration Notice	Section 8.4(i)
Annual Statement Date	Section 3.10
Balance Sheet	Section 3.10
Business	Preamble
Closing	Section 2.2(i)
Company	Preamble
Company IP	Section 3.15(i)
Compliance Laws	Section 3.13(i)
Disclosure Schedule	Section 3
Dispute	Section 8.4(i)
ESOP	Section 3.2(i)
Financial Statements	Section 3.10
HKIAC	Section 8.4(ii)
HKIAC Rules	Section 8.4(ii)
Investor/Investors	Preamble
Licenses	Section 3.15(v)
Party/Parties	Preamble
Principal	Preamble
Purchase Price	Section 2.1
Representatives	Section 3.13(i)
SEC	Section 4.3
Shares	Section 2.1
Statement Date	Section 3.10

**2. Purchase and Sale of Shares.**

**2.1 Sale and Issuance of the Shares.** Subject to the terms and conditions of this Agreement, at the Closing (as defined below), each Investor, severally and not jointly, agrees to subscribe for and purchase, and the Company agrees to issue and sell to such Investor, that number of Series B Preferred Shares set forth opposite such Investor's name on Schedule I attached hereto (the "Shares"), with each Investor to pay as consideration for such Shares the aggregate purchase price set forth opposite such Investor's name on Schedule I attached hereto (the "Purchase Price").

**2.2 Closing.**

(i) **Closing.** The consummation of the sale and issuance of the Shares pursuant to Section 2.1 (the "Closing") shall take place remotely via the exchange of documents and signatures as soon as practicable, but in no event later than three (3) Business Days after all closing conditions specified in Section 5 and Section 6 hereof have been waived or satisfied (other than those conditions to be satisfied at the Closing, but subject to the satisfaction or waiver thereof at the Closing), or at such other time and place as the Company and the Investors shall mutually agree in writing.

(ii) **Deliveries by the Company at Closing.** At the Closing, in addition to any items the delivery of which is made an express condition to the Investor's obligations at the Closing pursuant to Section 5, the Company shall deliver to each Investor (a) a scanned copy of the updated register of members of the Company, reflecting the issuance of Shares, and (b) a copy of duly executed certificate or certificates issued in the name of such Investor representing the Shares being purchased by such Investor at the Closings. Within ten (10) Business Days after the Closing, the Company shall deliver to the Investors the original share certificates representing the Shares being purchased by such Investors.

(iii) **Deliveries by the Investors at Closing.** At the Closing, subject to the satisfaction or waiver of all the conditions set forth in Section 5 below, each Investor shall pay the Purchase Price by wire transfer of immediately available funds in U.S. dollars to the bank account as set forth in Schedule IV attached hereto or any other bank account designated by the Company in writing.

(iv) If, at the Closing, any Investor shall fail to perform its obligations to fund its Purchase Price pursuant to Section 2.2(iii), the Closing shall take place with respect to the other Investors. The closing with respect to such Investor shall take place until such time they have fulfilled their obligations hereunder unless otherwise mutually agreed by the Company and such investor.

**3. Representations and Warranties of the Company.** Subject to such exceptions as may be specifically set forth in the disclosure schedule delivered by the Company to the Investors as of the date hereof and attached hereto as Schedule V (the "Disclosure Schedule") which forms part of the representation and warranties herein, the Company represents and warrants to the Investors that the following statements are true and correct as of the date hereof and as of the Closing:

**3.1 Organization, Good Standing and Qualification.** Each Group Company is duly organized, validly existing and in good standing (or equivalent status in the relevant jurisdiction) under, and by virtue of, the Laws of the place of its incorporation or establishment and has all requisite power and authority to own its properties and assets and to carry on its business as now conducted, and to perform each of its obligations under the Transaction Documents to which it is a party. Each Group Company is qualified to do business and is in good standing (or equivalent status in the relevant jurisdiction) in each jurisdiction where failure to be so qualified would be a Material Adverse Effect. Each Group Company has a valid business license issued by the relevant Government Authorities, and has, since its establishment, carried on its Business materially in compliance with the business scope set forth in its business license.

### 3.2 Capitalization and Voting Rights.

(i) **Company.** The authorized share capital of the Company is and immediately prior to the Closing shall be US\$50,000 divided into (a) a total of 492,179,086 authorized Ordinary Shares, 8,840,321 of which are issued and outstanding, and 4,165,310 of which have been reserved for issuance to officers, directors, employees, consultants or service providers of the Company pursuant to an equity incentive plan of the Company (the "ESOP"); (b) 2,377,642 Series A Preferred Shares of par value US\$0.0001 each, all of which are issued and outstanding; and (c) 5,443,272 Series B Preferred Shares of par value US\$0.0001 each, none of which are issued and outstanding. Section 3.2(i) of the Disclosure Schedule set forth the capitalization table of each Group Company as of immediately prior to the Closing, and immediately after the Closing, in each case reflecting all the outstanding and authorized Equity Securities of such Group Company, the record and beneficial holders thereof, the issuance date, and the terms of any vesting applicable thereto.

(ii) **No Other Securities.** Except for (a) the conversion privileges of the Preferred Share, and (b) certain rights provided in the Memorandum and Article and the Shareholders Agreement, (1) there are no and at the Closing there shall be no other authorized or outstanding Equity Securities of any Group Company; (2) no Equity Securities of any Group Company are subject to any preemptive rights, rights of first refusal or other rights to purchase such Equity Securities or any other rights with respect to such Equity Securities, and (3) no Group Company is a party or subject to any Contract that affects or relates to the voting or giving of written consents with respect to, or the right to cause the redemption, or repurchase of, any Equity Security of such Group Company. Except as set forth in the Shareholders Agreement, the Company has not granted any registration or information rights to any other Person, nor is the Company obliged to list, any of the Equity Securities of any Group Companies on any securities exchange. Except as contemplated under the Transaction Documents, there are no voting or similar agreements which relate to the share capital or registered capital of any Group Company.

(iii) **Issuance and Status.** All share capital or registered capital, as the case may be, of each Group Company have been duly and validly issued, are fully paid (or subscribed for) and nonassessable, and are and as of the Closing shall be free of any and all Liens (except for any restrictions on transfer under the Shareholders Agreement and applicable Laws). Except as contemplated under the Transaction Documents, there are no (a) resolutions pending to increase the share capital or registered capital of any Group Company or cause the liquidation, winding up, or dissolution of any Group Company, nor has any distress, execution or other process been levied against any Group Company, (b) dividends which have accrued or been declared but are unpaid by any Group Company, (c) obligations, contingent or otherwise, of any Group Company to repurchase, redeem, or otherwise acquire any Equity Securities, or (d) outstanding or authorized equity appreciation, phantom equity, equity plans or similar rights with respect to any Group Company. All dividends (if any) or distributions (if any) declared, made or paid by each Group Company, and all repurchases and redemptions of Equity Securities of each Group Company (if any), have been declared, made, paid, repurchased or redeemed, as applicable, in accordance with its Charter Documents and all applicable Laws.

(iv) **Title.** Each Group Company is the sole record and beneficial holder of all of the Equity Securities set forth opposite its name on Section 3.2(i) of the Disclosure Schedule, free and clear of all Liens of any kind other than those arising under applicable Law or as set forth in the Transaction Documents.

**3.3 Corporate Structure; Subsidiaries.** Section 3.3 of the Disclosure Schedule sets forth a complete structure chart showing Group Companies, and indicating the ownership and Control relationships among all Group Companies, the nature of the legal entity which each Group Company constitutes, the jurisdiction in which each Group Company was organized, and each jurisdiction in which each Group Company is required to be qualified or licensed to do business as a foreign Person. No Group Company owns or Controls, or has ever owned or Controlled, directly or indirectly, any Equity Security, interest or share in any other Person or is or was a participant in any joint venture, partnership or similar arrangement. No Group Company is obligated to make any investment in or capital contribution in or on behalf of any other Person.

**3.4 Authorization.** The Company has all requisite power and authority to execute and deliver the Transaction Documents to which it is a party and to carry out and perform its obligations thereunder. The authorization, issuance (or reservation for issuance), sale and delivery of the Shares and the reservation for issuance the Conversion Shares, has been taken or will be taken prior to the Closing or at the Closing, as applicable. Each Transaction Document, when executed and delivered, constitutes valid and legally binding obligations of such party, enforceable against such party in accordance with its terms, except (i) as limited by applicable bankruptcy, insolvency, reorganization, moratorium, and other Laws of general application affecting enforcement of creditors' rights generally, and (ii) as limited by Laws relating to the availability of specific performance, injunctive relief, or other equitable remedies.

**3.5 Valid Issuance of Shares.** The Shares, when issued, delivered and paid for in accordance with the terms of this Agreement for the consideration expressed herein, will be duly and validly issued, fully paid and non-assessable, free from any Liens (except for any restrictions on transfer under applicable Laws and under the Shareholders Agreement). The Conversion Shares will be reserved at Closing for issuance and, upon issuance in accordance with the terms of the Memorandum and Articles, will be duly and validly issued, fully paid and non-assessable, free from any Liens (except for any restrictions on transfer under applicable securities Laws and under the Shareholders Agreement). The issuance of the Shares and the Conversion Shares will not be subject to any preemptive rights, rights of first refusal or similar rights other than those that have been or will be duly waived prior to or at the Closing, as applicable.

**3.6 Consents; No Conflicts.** All Consents from or with any Governmental Authority or any other Person required in connection with the execution, delivery and performance of the Transaction Documents by the Company, and the consummation of the transactions contemplated by the Transaction Documents by the Company, have been duly obtained or completed (as applicable) and are in full force and effect. The execution, delivery and performance of each Transaction Document by the Company do not, and the consummation by the Company of the transactions contemplated thereby will not, with or without notice or lapse of time or both, (i) result in any violation of, be in conflict with, or constitute a default under any provision of any Charter Document of the Company, or (ii) result in any violation of, be in conflict with, or constitute a default under, in any material respect, any Governmental Order or any applicable Law.

**3.7 Offering.** Subject in part to the accuracy of the Investors' representations set forth in Section 4 of this Agreement, the offer, sale and issuance of the Shares are, and the issuance of the Conversion Shares will be, exempt from the qualification, registration and prospectus delivery requirements of the Securities Act and any other applicable securities Laws.

**3.8 Compliance with Laws; Consents.**

(i) Each Group Company is, and has been, in compliance in all material respects with all applicable Laws. To the Company's Knowledge, no event has occurred and no circumstance exists that (with or without notice or lapse of time) (a) may constitute or result in a violation by any Group Company of, or a failure on the part of such entity to comply with, any applicable Laws in any material respect, or (b) may give rise to any obligation on the part of any Group Company to undertake, or to bear all or any portion of the cost of, any remedial action of any nature. None of the Group Companies has received any notice from any Governmental Authority regarding any of the foregoing. To the Knowledge of the Company, no Group Company is under investigation with respect to a material violation of any Law.

(ii) All material Consents from or with the relevant Governmental Authority required in respect of the due and proper establishment and operations of each Group Company as now conducted, including but not limited to the Consents from or with authorities, product registration authorities, and health regulatory authorities and the local counterpart thereof, as applicable (or any predecessors thereof, as applicable), have been duly obtained or completed in accordance with all applicable Laws.

(iii) None of the Group Companies is in default in any material respect under any required Governmental Consent. No Group Company has received any letter or other written communication from any Governmental Authority threatening or providing notice of revocation of any Required Governmental Consent issued to any Group Company or the need for compliance or remedial actions in respect of the activities carried out directly or indirectly by any Group Company.

**3.9 Tax Matters.**

(i) Each Group Company (a) has timely filed all income and other material Tax Returns that are required to have been filed by it with any Governmental Authority, (b) has timely paid all Taxes owed by it which are due and payable (whether or not shown on any Tax Return), except to the extent any failure to timely pay such Taxes would not have a Material Adverse Effect.

(ii) Each Tax Return referred to in paragraph (i) above was properly prepared in compliance with applicable Law and was (and will be) true, correct and complete in all material respects. No reporting position was taken on any such Tax Return which has not been disclosed to the appropriate Tax authority or in such Tax Return, as may be required by Law. All records relating to such Tax Returns or to the preparation thereof required by applicable Law to be maintained by applicable Group Company have been duly maintained. No written claim has been made by a Governmental Authority in a jurisdiction where the Group does not file Tax Returns that any Group Company is or may be subject to taxation by that jurisdiction.

(iii) There is no pending dispute with, or notice from, any Tax authority relating to any of the Tax Returns filed by any Group Company, and to the Knowledge of the Company, there is no proposed Liability for a deficiency in any Tax to be imposed upon the properties or assets of any Group Company.

(iv) No Group Company has been the subject of any examination or investigation by any Tax authority relating to the conduct of its business or the payment or withholding of Taxes that has not been resolved or is currently the subject of any examination or investigation by any Tax authority relating to the conduct of its business or the payment or withholding of Taxes.

(v) The Company is treated as a corporation for U.S. federal income tax purposes.

**3.10 Financial Statements.** Section 3.10 of the Disclosure Schedule sets forth the unaudited consolidated balance sheet and statements of operations for the Group as of and for the twelve-months ending December 31, 2019 (the “Annual Statement Date”) and the unaudited consolidated balance sheet (the “Balance Sheet”) and statements of operations for the Group as of and for the 11-month period ending November 30, 2020 (the “Statement Date”) (collectively, the financial statements referred to above, the “Financial Statements”). The Financial Statements (a) have been prepared in accordance with the books and records of the Group, (b) fairly present in all material respects the financial condition and position of the Group as of the dates indicated therein and the results of operations of the Group for the periods indicated therein, except in the case of unaudited financial statements for the omission of notes thereto and normal year-end audit adjustments that are not expected to be material, and (c) were prepared in accordance with the Accounting Standards applied on a consistent basis throughout the periods involved.

**3.11 Actions.** There is no material Action pending or, to the Knowledge of the Company, threatened against or affecting any Group Company or any of its officers, directors or employees with respect to its businesses or proposed business activities, or, to the Knowledge of the Company, any officers, directors or employees of any Group Company in connection with such person’s respective relationship with such Group Company. There is no judgment or award unsatisfied against any Group Company, nor is there any Governmental Order in effect and binding on any Group Company or their respective assets or properties. There is no material Action pending by any Group Company against any third party nor does any Group Company intend to commence any such Action. No Governmental Authority has at any time challenged or questioned in writing the legal right of any Group Company to conduct in any material respect its business as presently being conducted.

**3.12 Liabilities.** No Group Company has any Liabilities of the type required to be disclosed on a balance sheet except for (i) liabilities set forth in the Balance Sheet that have not been satisfied since the Statement Date, and (ii) current liabilities, including payables to vendors, incurred since the Statement Date in the ordinary course of the Group’s business consistent with its past practices and which do not exceed US\$0 in the aggregate. Except as set forth in Section 3.12 of the Disclosure Schedule and except for Indebtedness incurred in the ordinary course of the Group’s business consistent with its past practices, none of the Group Companies has any outstanding Indebtedness. None of the Group Companies is a guarantor or indemnitor of any Liabilities of any other Person (other than a Group Company).

**3.13 Anti-Bribery, Anti-Corruption, Anti-Money Laundering and Sanctions; Absence of Government Interests.**

(i) Each Group Company and to the Knowledge of the Company, their respective directors, officers, employees, agents and other persons acting on their behalf (collectively, “Representatives”) are and have been in material compliance with all applicable Laws relating to anti-bribery, anti-corruption, anti-money laundering, record keeping and internal control laws (collectively, the “Compliance Laws”) including the FCPA as if it were a U.S. Person. Furthermore, no Public Official (i) holds an ownership or other economic interest, direct or indirect, in any of the Group Companies or in the contractual relationship formed by this Agreement, or (ii) serves as an officer, director or employee of any Group Company. To the Knowledge of the Company, neither any Group Company nor any Representative has, directly or indirectly, offered, authorized, promised, condoned, participated in, consummated, or received notice of any allegation of,



(a) the making of any gift or payment of anything of value to any Public Official by any Person to obtain any improper advantage, affect or influence any act or decision of any such Public Official, or assist any Group Company in obtaining or retaining business for, or with, or directing business to, any Person.

(b) the taking of any action by any Person which (i) would violate the FCPA, if taken by an entity subject to the FCPA, or (ii) could reasonably be expected to constitute a violation of any applicable Compliance Law, or

(c) the making of any false or fictitious entries in the books or records of any Group Company by any Person, or

(d) the using of any assets of any Group Company for the establishment of any unlawful or unrecorded fund of monies or other assets, or the making of any unlawful or undisclosed payment.

(ii) No Group Company or any of its Representatives has ever been found by a Governmental Authority to have violated any criminal or securities Law or is subject to any indictment or any government investigation for bribery. None of the beneficial owners of any Equity Securities or other interest in any Group Company or the current or former Representatives of any Group Company are or were Public Officials.

(iii) No Group Company or any of its Representatives is a Prohibited Person, and no Prohibited Person will be given an offer to become an employee, officer, consultant or director of any Group Company. No Group Company has conducted or agreed to conduct any business, or entered into or agreed to enter into any transaction with a Prohibited Person.

(iv) If the Group Companies have beneficial owners or Representatives who are Public Officials, to the Knowledge of the Company, no such Public Official has been involved on behalf of a Governmental Authority in decisions as to whether any Group Company or the Investors would be awarded business or that otherwise could benefit any Group Company or the Investors, or in the appointment, promotion, or compensation of persons who will make such decisions.

**3.14 Related Party Transactions.** Other than as set forth in Section 3.14 of the Disclosure Schedule, no Related Party has any Contract with, or is indebted to, any Group Company or has any direct or indirect interest in any Group Company (other than as set forth in Section 3.2(i) of the Disclosure Schedule), nor is any Group Company indebted (or committed to make loans or extend or guarantee credit) to any Related Party (other than for accrued salaries for the current pay period, reimbursable expenses or other standard employee benefits). No Related Party has any direct or indirect interest in any Person with which a Group Company is affiliated or with which a Group Company has a material business relationship (including any Person which purchases from or sells, licenses or furnishes to a Group Company any goods, intellectual or other property rights or services) or in any Contract to which a Group Company is a party or by which it may be bound or affected, and no Related Party directly or indirectly competes with or has any interest in any Person that directly or indirectly competes with any Group Company (other than ownership of less than one percent (1%) of the stock of publicly traded companies), in each case except for as specifically disclosed in Section 3.14 of the Disclosure Schedule.

### 3.15 Intellectual Property Rights.

(i) **Company IP.** Each Group Company owns or otherwise has sufficient rights (including but not limited to the rights of development, maintenance, licensing and sale) to all Intellectual Property necessary and sufficient to conduct its Business (“Company IP”) without any conflict with or infringement of the rights of any other Person. Section 3.15(i), of the Disclosure Schedule sets forth a complete and accurate list of all Company Registered IP for each Group Company.

(ii) **IP Ownership.** All Company Registered IP is owned by a Group Company, is valid and subsisting and has not been abandoned, and all necessary registration, maintenance and renewal fees with respect thereto and currently due have been satisfied. To the Knowledge of the Company, no Group Company or any of its employees, officers or directors has taken any actions or failed to take any actions that would cause any Company Owned IP to be invalid, unenforceable or not subsisting. No Group Company is or has been a member or promoter of, or contributor to, any industry standards bodies, patent pooling organizations or similar organizations that could require or obligate a Group Company to grant or offer to any Person any license or right to any material Company Owned IP. No Company Owned IP is subject to any proceeding or outstanding Governmental Order or settlement agreement or stipulation that (a) restricts in any manner the use, transfer or licensing thereof, or the making, using, sale, or offering for sale of any Group Company’s products or services, by any Group Company or (b) may affect the validity, use or enforceability of such Company Owned IP. No Group Company has (a) transferred or assigned any material Company Owned IP to any other Person; (b) authorized the joint ownership of other Person in any material Company Owned IP; or (c) permitted the rights of any Group Company in any material Company Owned IP to lapse or enter into the public domain.

(iii) **Infringement, Misappropriation and Claims.** To the Knowledge of the Company, no Group Company has misappropriated, or to the Knowledge of the Company, violated, or infringed in any material respect any Intellectual Property of any other Person, nor has any Group Company received any written notice alleging any of the foregoing. To the Knowledge of the Company, no Person has violated, infringed or misappropriated any material Company Owned IP of any Group Company, and no Group Company has given any written notice to any other Person alleging any of the foregoing. To the Knowledge of the Company, no Person has challenged the ownership or use of any material Company IP by a Group Company. No Group Company has agreed to indemnify any Person for any infringement, violation or misappropriation of any Intellectual Property by such Person.

(iv) **Assignments and Prior IP.** All material inventions and material know-how conceived by employees of a Group Company related to the Business of such Group Company are currently owned exclusively by a Group Company. All employees, contractors, agents and consultants of a Group Company who are or were involved in the creation of any material Intellectual Property for such Group Company have executed an assignment of inventions agreement that vests in a Group Company exclusive ownership of all right, title and interest in and to such Intellectual Property, to the extent not already provided by Law. All employee inventors of Company Owned IP have received reasonable reward and remunerations from a Group Company for his/her service inventions or service technology achievements in accordance with the applicable laws. To the Knowledge of the Company, it will not be necessary to utilize any Intellectual Property of any such Persons made prior to their employment by a Group Company, except for those that are exclusively owned by a Group Company, and none of such Intellectual Property has been utilized by any Group Company. To the Knowledge of the Company, none of the employees, consultants or independent contractors, currently or previously employed or otherwise engaged by any Group Company, (a) is in violation of any current or prior confidentiality, non-competition or non-solicitation obligations to such Group Company or to any other Persons, including former employers, or (b) is obligated under any Contract, or subject to any Governmental Order, that would interfere with the use of his or her best efforts to promote the interests of the Group Companies or that would conflict with the business of such Group Company as presently conducted.

(v) **Licenses.** Section 3.15(v) of the Disclosure Schedule contains a complete and accurate list of the following (collectively, the “Licenses”): (a) all licenses, sublicenses, and other Contracts to which any Group Company is a party and pursuant to which any third party is authorized to use, exercise or receive any benefit from any material Company IP, and (b) all licenses, sublicenses and other Contracts to which any Group Company is a party and pursuant to which such Group Company is authorized to use, exercise, or receive any benefit from any material Intellectual Property of another Person, in each case except for (1) agreements involving “off-the-shelf” commercially available software, and (2) non-exclusive licenses to customers of the Business in the ordinary course of business consistent with past practice.

(vi) **Protection of IP.** Each Group Company has taken reasonable and appropriate steps to protect, maintain and safeguard material Company Owned IP and made all applicable filings, registrations and payments of fees in connection with the foregoing. Without limiting the foregoing, to the Knowledge of the Company, all current and former officers, employees, consultants and independent contractors of any Group Company and all suppliers, customers, distributors, and other third parties having access to any material Company IP have executed and delivered to such Group Company an agreement requiring the protection of such Company IP. To the extent that any material Company IP has been developed or created independently or jointly by an independent contractor or other third party for any Group Company, or is incorporated into any products or services of any Group Company, such Group Company has a written agreement with such independent contractor or third party and has thereby obtained ownership of, and is the exclusive owner of all such independent contractor’s or third party’s Intellectual Property in such work, material or invention by operation of law or valid assignment.

**3.16 Labor and Employment Matters.**

(i) Each Group Company has complied in all material respects with all applicable Laws related to labor or employment, including provisions thereof relating to wages, hours, working conditions, benefits, retirement, social welfare, equal opportunity and collective bargaining. There is not pending or to the Knowledge of the Company threatened, and there has not been in the last three (3) years, any Action relating to the violation or alleged violation of any applicable Laws by any Group Company related to labor or employment, including any charge or complaint filed by an employee with any Governmental Authority or any Group Company.

(ii) Section 3.16(ii) of the Disclosure Schedule contains a true and complete list of each Benefit Plan currently or previously adopted, maintained, or contributed to by any Group Company or under which any Group Company has any Liability or under which any employee or former employee of any Group Company has any present or future right to benefits.

**3.17 Entire Business.** No Group Company provides any facilities, operational services, assets or properties to any other entity which is not a Group Company.

4. **Representations and Warranties of the Investors.** Each Investor hereby represents and warrants to the Company, severally and not jointly, that:

**4.1 Authorization.** Such Investor has all requisite power and authority to execute and deliver the Transaction Documents to which it is a party and to carry out and perform its obligations thereunder. All action on the part of such Investor (and, as applicable, its officers, directors and shareholders) necessary for the authorization, execution and delivery of the Transaction Documents to which it is a party, and the performance of all obligations of such Investor thereunder, has been taken or will be taken prior to or at the Closing, as applicable. Each Transaction Document that has been duly executed and delivered by such Investor (to the extent such Investor is a party), constitutes valid and legally binding obligations of such Investor, enforceable against such Investor in accordance with its terms, except (i) as limited by applicable bankruptcy, insolvency, reorganization, moratorium, and other Laws of general application affecting enforcement of creditors' rights generally, and (ii) as limited by Laws relating to the availability of specific performance, injunctive relief, or other equitable remedies.

**4.2 Purchase for Own Account.** The Shares and the Conversion Shares will be acquired for such Investor's own account, not as a nominee or agent, and not with a view to or in connection with the sale or distribution of any part thereof, and that the Purchaser has no present intention of selling, granting any participation in, or otherwise distributing the same. By executing this Agreement, the Investor further represents that the Investor does not presently have any contract, undertaking, agreement or arrangement with any Person to sell, transfer or grant participations to such Person or to any third Person, with respect to any of the Shares and the Conversion Shares. The Investor has not been formed for the specific purpose of acquiring the Shares and the Conversion Shares.

**4.3 Status of Investor.** Such Investor is either (i) an "accredited investor" within the meaning of Securities and Exchange Commission ("SEC") Rule 501 of Regulation D, as presently in effect, under the Securities Act, or (ii) not a "U.S. person" as defined in Rule 902 of Regulation S of the Securities Act. Such Investor has the knowledge, sophistication and experience necessary to make an investment decision like that involved in the purchase of the applicable Shares and can bear the economic risk of its investment in the Shares. Such Investor represents that by reason of its, or of its management's, business or financial experience, such Investor has the capacity to protect its own interests in connection with the transactions contemplated in the Transaction Documents. Further, such Investor is aware of no publication of any advertisement in connection with the transactions contemplated in the Agreement.

**4.4 Disclosure of Information.** Such Investor has had an opportunity to discuss the Company's business, management and financial affairs with directors, officers and management of the Company and has had the opportunity to review the Company's operations and facilities. Such Investor has also had the opportunity to ask questions of and receive answers from, the Company and its management regarding the terms and conditions of this investment.

**4.5 Restricted Securities.** Such Investor understands that the Shares and the Conversion Shares are restricted securities within the meaning of Rule 144 under the Securities Act; and that the Shares and the Conversion Shares are not registered or listed publicly and must be held indefinitely unless they are subsequently registered or listed publicly or an exemption from such registration or listing is available. Such Investor understands that the Company has no present intention of registering the Shares or the Conversion Shares. Such Investor also understands that there is no assurance that any exemption from registration under the Securities Act will be available and that, even if available, such exemption may not allow the Investor to transfer all or any portion of the Shares or the Conversion Shares under the circumstances, in the amounts or at the times the Investor might propose.

**4.6 No Brokers.** Neither such Investor nor any of its Affiliates has any Contract with any broker, finder or similar agent with respect to the transactions contemplated by this Agreement or by any of the Transaction Documents, and none of them has incurred any Liability for any brokerage fees, agents' fees, commissions or finders' fees in connection with any of the Transaction Documents or the consummation of the transactions contemplated therein.

**4.7 Legends.** Such Investor understands that the Shares and the Conversion Shares, may be notated with one or all of the following legends:

(i) "THE SHARES REPRESENTED HEREBY HAVE NOT BEEN REGISTERED UNDER THE SECURITIES ACT OF 1933, AND HAVE BEEN ACQUIRED FOR INVESTMENT AND NOT WITH A VIEW TO, OR IN CONNECTION WITH, THE SALE OR DISTRIBUTION THEREOF. NO SUCH TRANSFER MAY BE EFFECTED WITHOUT AN EFFECTIVE REGISTRATION STATEMENT RELATED THERETO OR AN OPINION OF COUNSEL IN A FORM SATISFACTORY TO THE COMPANY THAT SUCH REGISTRATION IS NOT REQUIRED UNDER THE SECURITIES ACT OF 1933."

(ii) Any legend set forth in, or required by, the other Transaction Agreements.

(iii) Any legend required by the securities laws of any state to the extent such laws are applicable to the Shares and the Conversion Shares represented by the certificate, instrument, or book entry so legended.

**4.8 No General Solicitation.** Neither the Investor, nor any of its officers, directors, employees, agents, stockholders or partners has either directly or indirectly, including, through a broker or finder (a) engaged in any general solicitation, or (b) published any advertisement in connection with the offer and sale of the Shares.

**4.10 Residence.** If the Investor is an individual, then the Investor resides in the state or province identified in the address of Investor set forth on Schedule II; if the Investor is a partnership, corporation, limited liability company or other entity, then the office or offices of Investor in which its investment decision was made is located at the address or addresses of the Investor set forth on Schedule II.

**4.11 Transfer Restrictions.** Each Investor acknowledges and agrees that the Shares and, if issued, the Conversion Shares are subject to restrictions on transfer as set forth in the Shareholders Agreement.

**5. Conditions of the Investors' Obligations at the Closing.** The obligations of each Investor to consummate the Closing under Section 2 of this Agreement are subject to the fulfillment, to the satisfaction of such Investor on or prior to the Closing, or waiver by such Investor, of the following conditions:

**5.1 Representations and Warranties.** Each of the representations and warranties of the Company contained in Section 3 shall have been true and complete when made and shall be true and complete in all material respects on and as of the Closing with the same effect as though such representations and warranties had been made on and as of the date of such Closing, except in either case for those representations and warranties that address matters only as of a particular date, which representations will have been true and complete as of such particular date.

**5.2 Performance.** The Company shall have performed and complied with all obligations and conditions contained in the Transaction Documents that are required to be performed or complied with by them on or before the Closing.

**5.3 Authorizations.** All Consents of any competent Governmental Authority or of any other Person that are required to be obtained by the Company in connection with the consummation of the transactions contemplated by the Transaction Documents (including but not limited to those related to the lawful issuance and sale of the Shares, and any waivers of notice requirements, rights of first refusal, preemptive rights, put or call rights), including necessary board and shareholder approvals of the Company, shall have been duly obtained and effective as of the Closing, and evidence thereof shall have been delivered to the Investors as it may reasonably request.

**5.4 Proceedings and Documents.** All corporate and other proceedings in connection with the transactions to be completed at the Closing and all documents incident thereto with respect to this Agreement and the other Transaction Documents and the transactions contemplated hereby and thereby, shall have been completed in form and substance reasonably satisfactory to the Investors, and each Investor shall have received all such counterpart original or other copies of such documents as it may reasonably request.

**5.5 Memorandum and Articles.** The Memorandum and Articles, in the forms attached hereto as Exhibit A-1 and Exhibit A-2, respectively, shall have been duly adopted by all necessary action of the Board of Directors and/or the members of the Company, and such adoption shall have become effective prior to the Closing with no alternation or amendment as of the Closing.

**5.6 Transaction Documents.** Each of the parties to the Transaction Documents, other than the Investors, shall have executed and delivered such Transaction Documents to the Investors.

**6. Conditions of the Company's Obligations at Closing.** The obligations of the Company owed to each Investor to consummate the Closing under Section 2 of this Agreement, unless otherwise waived in writing by the Company, are subject to the fulfillment on or before the Closing of each of the following conditions:

**6.1 Representations and Warranties.** The representations and warranties of such Investor contained in Section 4 shall have been true and complete when made and shall be true and complete on and as of the Closing with the same effect as though such representations and warranties had been made on and as of the date of the Closing, except in either case for those representations and warranties that address matters only as of a particular date, which representations will have been true and complete as of such particular date.

**6.2 Performance.** Such Investor shall have performed and complied with all covenants, obligations and conditions contained in this Agreement that are required to be performed or complied with by such Investor on or before the Closing.

**6.3 Execution of Transaction Documents.** Such Investor shall have executed and delivered to the Company the Transaction Documents, to which such Investor is a party.

**7. Other Agreements.**

**7.1 Confidentiality.** The terms and conditions of the Transaction Documents (collectively, the “**Financing Terms**”), including their existence, shall be considered confidential information and shall not be disclosed by any of the Parties to any other Person except that (i) each Party, as appropriate, may disclose any of the Financing Terms to its current or bona fide prospective investors, employees, investment bankers, lenders, accountants and attorneys, in each case only where such Persons are under appropriate nondisclosure obligations; (ii) each Investor may disclose any of the Financing Terms to its fund manager and the employees thereof so long as such Persons are under appropriate nondisclosure obligations; and (iii) if any Party is requested or becomes legally compelled (including without limitation, pursuant to securities Laws) to disclose the existence or content of any of the Financing Terms in contravention of the provisions of this Section, such Party shall promptly provide the other Parties with written notice of that fact so that such other Parties may seek a protective order, confidential treatment or other appropriate remedy and in any event shall furnish only that portion of the information that is legally required and shall exercise reasonable efforts to obtain reliable assurance that confidential treatment will be accorded such information.

**8. Miscellaneous.**

**8.1 Further Assurances.** Upon the terms and subject to the conditions herein, each of the Parties hereto agrees to use its reasonable best efforts to take or cause to be taken all action, to do or cause to be done, to execute such further instruments, and to assist and cooperate with the other Parties hereto in doing, all things necessary, proper or advisable under applicable Laws or otherwise to consummate and make effective, in the most expeditious manner practicable, the transactions contemplated by this Agreement and the other Transaction Documents (it being understood that no Party shall be obligated to grant any waiver of any condition or other waiver hereunder).

**8.2 Successors and Assigns.** Except as otherwise provided herein, the terms and conditions of this Agreement shall inure to the benefit of and be binding upon the respective successors and assigns of the Parties hereto whose rights or obligations hereunder are affected by such terms and conditions. This Agreement and the rights and obligations therein may not be assigned by the Company without the prior written consent of the Investors. Nothing in this Agreement, express or implied, is intended to confer upon any Party other than the Parties hereto or their respective successors and assigns any rights, remedies, obligations, or liabilities under or by reason of this Agreement, except as expressly provided in this Agreement.

**8.3 Governing Law.** This Agreement shall be governed by and construed under the Laws of Hong Kong, without regard to principles of conflict of Laws thereunder.

**8.4 Dispute Resolution.**

(i) Any dispute, controversy or claim (each, a “Dispute”) arising out of or relating to this Agreement, or the interpretation, breach, termination, validity or invalidity thereof, shall be referred to arbitration upon the demand of either party to the dispute with notice (the “Arbitration Notice”) to the other.

(ii) The Dispute shall be settled by arbitration in Hong Kong by the Hong Kong International Arbitration Centre (the “HKIAC”) in accordance with the Hong Kong International Arbitration Centre Administered Arbitration Rules (the “HKIAC Rules”) in force when the Arbitration Notice is submitted in accordance with the HKIAC Rules. There shall be one (1) arbitrator. The HKIAC Council shall select the arbitrator, who shall be qualified to practice law in Hong Kong.

(iii) The arbitral proceedings shall be conducted in English. To the extent that the HKIAC Rules are in conflict with the provisions of this Section, including the provisions concerning the appointment of the arbitrators, the provisions of this Section shall prevail.

(iv) Each party to the arbitration shall cooperate with each other party to the arbitration in making full disclosure of and providing complete access to all information and documents requested by such other party in connection with such arbitral proceedings, subject only to any confidentiality obligations binding on such party.



(v) The award of the arbitral tribunal shall be final and binding upon the parties thereto, and the prevailing party may apply to a court of competent jurisdiction for enforcement of such award.

(vi) The arbitral tribunal shall decide any Dispute submitted by the parties to the arbitration strictly in accordance with the substantive Laws of Hong Kong (without regard to principles of conflict of Laws thereunder) and shall not apply any other substantive Law.

(vii) Any party to the Dispute shall be entitled to seek preliminary injunctive relief, if possible, from any court of competent jurisdiction pending the constitution of the arbitral tribunal.

(viii) During the course of the arbitral tribunal's adjudication of the Dispute, this Agreement shall continue to be performed except with respect to the part in dispute and under adjudication.

**8.5 Notices.** Any notice required or permitted pursuant to this Agreement shall be given in writing and shall be given either personally or by sending it by next-day or second-day courier service, fax, electronic mail or similar means to the address of the relevant Party as shown on Schedule II (or at such other address as such Party may designate by fifteen (15) days' advance written notice to the other Parties to this Agreement given in accordance with this Section). Where a notice is sent by next-day or second-day courier service, service of the notice shall be deemed to be effected by properly addressing, pre-paying and sending by next-day or second-day service through an internationally-recognized courier a letter containing the notice, with a written confirmation of delivery, and to have been effected at the earlier of (i) delivery (or when delivery is refused) and (ii) expiration of two (2) Business Days after the letter containing the same is sent as aforesaid. Where a notice is sent by fax or electronic mail, service of the notice shall be deemed to be effected by properly addressing, and sending such notice through a transmitting organization, with a written confirmation of delivery, and to have been effected on the day the same is sent as aforesaid, if such day is a Business Day and if sent during normal business hours of the recipient, otherwise the next Business Day. Notwithstanding the foregoing, to the extent a "with a copy to" address is designated, notice must also be given to such address in the manner above for such notice, request, consent or other communication hereunder to be effective.

**8.6 Rights Cumulative; Specific Performance.** Each and all of the various rights, powers and remedies of a party hereto will be considered to be cumulative with and in addition to any other rights, powers and remedies which such Party may have at Law or in equity in the event of the breach of any of the terms of this Agreement. The exercise or partial exercise of any right, power or remedy will neither constitute the exclusive election thereof nor the waiver of any other right, power or remedy available to such Party. Without limiting the foregoing, the Parties hereto acknowledge and agree irreparable harm may occur for which money damages would not be an adequate remedy in the event that any of the provisions of this Agreement were not performed in accordance with their specific terms or were otherwise breached. It is accordingly agreed that the Parties shall be entitled to injunction to prevent breaches of this Agreement and to enforce specifically the terms and provisions of this Agreement.

**8.7 Fees and Expenses.** Each of the parties hereto shall bear its own costs and expenses in connection with the negotiation, execution, delivery and performance of this Agreement and the other Transaction Documents and the transactions contemplated hereby and thereby. If any action at Law or in equity is necessary to enforce or interpret the terms of this Agreement, the prevailing party shall be entitled to reasonable attorney's fees, costs and necessary disbursements in addition to any other relief to which such party may be entitled.

**8.8 Severability.** In case any provision of the Agreement shall be invalid, illegal or unenforceable, the validity, legality and enforceability of the remaining provisions shall not in any way be affected or impaired thereby. If, however, any provision of this Agreement shall be invalid, illegal, or unenforceable under any such applicable Law in any jurisdiction, it shall, as to such jurisdiction, be deemed modified to conform to the minimum requirements of such Law, or, if for any reason it is not deemed so modified, it shall be invalid, illegal, or unenforceable only to the extent of such invalidity, illegality, or limitation on enforceability without affecting the remaining provisions of this Agreement, or the validity, legality, or enforceability of such provision in any other jurisdiction.

**8.9 Amendments and Waivers.** Any term of this Agreement may be amended, only with the written consent of each of (i) the Company, and (ii) the Investors that shall hold at least a majority of Shares immediately after the Closing. Any amendment effected in accordance with this paragraph shall be binding upon each of the Parties hereto. Notwithstanding the foregoing, the observance of any term of this Agreement may be waived (either generally or in a particular instance and either retroactively or prospectively) only with the written consent of the Party against whom such waiver is sought.

**8.10 No Waiver.** Failure to insist upon strict compliance with any of the terms, covenants, or conditions hereof will not be deemed a waiver of such term, covenant, or condition, nor will any waiver or relinquishment of, or failure to insist upon strict compliance with, any right, power or remedy power hereunder at any one or more times be deemed a waiver or relinquishment of such right, power or remedy at any other time or times.

**8.11 Delays or Omissions.** No delay or omission to exercise any right, power or remedy accruing to any Party under this Agreement, upon any breach or default of any other Party under this Agreement, shall impair any such right, power or remedy of such non-breaching or non-defaulting Party nor shall it be construed to be a waiver of any such breach or default, or an acquiescence therein, or of or in any similar breach or default thereafter occurring; nor shall any waiver of any single breach or default be deemed a waiver of any other breach or default theretofore or thereafter occurring. Any waiver, permit, consent or approval of any kind or character on the part of any Party of any breach or default under this Agreement, or any waiver on the part of any Party of any provisions or conditions of this Agreement, must be in writing and shall be effective only to the extent specifically set forth in such writing.

**8.12 No Presumption.** The Parties acknowledge that any applicable Law that would require interpretation of any claimed ambiguities in this Agreement against the Party that drafted it has no application and is expressly waived. If any claim is made by a Party relating to any conflict, omission or ambiguity in the provisions of this Agreement, no presumption or burden of proof or persuasion will be implied because this Agreement was prepared by or at the request of any Party or its counsel.

**8.13 Headings and Subtitles; Interpretation.** The titles and subtitles used in this Agreement are used for convenience only and are not to be considered in construing or interpreting this Agreement. Unless a provision hereof expressly provides otherwise: (i) the term “or” is not exclusive; (ii) words in the singular include the plural, and words in the plural include the singular; (iii) the terms “herein”, “hereof”, and other similar words refer to this Agreement as a whole and not to any particular section, subsection, paragraph, clause, or other subdivision; (iv) the term “including” will be deemed to be followed by, “but not limited to”; (v) the masculine, feminine, and neuter genders will each be deemed to include the others; (vi) the terms “shall”, “will”, and “agrees” are mandatory, and the term “may” is permissive; (vii) the term “day” means “calendar day”, and “month” means calendar month, (viii) all references in this Agreement to designated “Sections” and other subdivisions are to the designated Sections and other subdivisions of the body of this Agreement, (ix) all references in this Agreement to designated Schedules, Exhibits and Appendices are to the Schedules, Exhibits and Appendices attached to this Agreement, (x) the phrase “directly or indirectly” means directly, or indirectly through one or more intermediate Persons or through contractual or other arrangements, and “direct or indirect” has the correlative meaning, (xi) references to laws include any such law modifying, re enacting, extending or made pursuant to the same or which is modified, re enacted, or extended by the same or pursuant to which the same is made, (xii) all accounting terms not otherwise defined herein have the meanings assigned under the Accounting Standards, (xiii) pronouns of either gender or neuter shall include, as appropriate, the other pronoun forms, (xiv) references to this Agreement, any other Transaction Documents and any other document shall be construed as references to such document as the same may be amended, supplemented or novated from time to time, and (xv) all references to dollars or to “US\$” are to currency of the United States of America and all references to RMB are to currency of the PRC (and each shall be deemed to include reference to the equivalent amount in other currencies).

**8.14 Counterparts.** This Agreement may be executed in two or more counterparts, each of which shall be deemed an original, but all of which together shall constitute one and the same instrument. Facsimile and e-mailed copies of signatures shall be deemed to be originals for purposes of the effectiveness of this Agreement.

**8.15 Entire Agreement.** This Agreement and the Transaction Documents, together with all schedules and exhibits hereto and thereto, constitute the full and entire understanding and agreement among the Parties with regard to the subjects hereof and thereof, and supersede all other agreements between or among any of the Parties with respect to the subject matters hereof and thereof.

**8.16 Use of English Language.** This Agreement has been executed and delivered in the English language. Any translation of this Agreement into another language shall have no interpretive effect.

*[The remainder of this page has been left intentionally blank]*

IN WITNESS WHEREOF, the parties hereto have caused their respective duly authorized representatives to execute this Agreement on the date and year first above written.

COMPANY:

Belite Bio, Inc

By: /s/ Tom Lin

Name: Tom Lin

Title: Director

---

[Share Purchase Agreement]

IN WITNESS WHEREOF, the parties hereto have caused their respective duly authorized representatives to execute this Agreement on the date and year first above written.

INVESTORS:

Lin Bioscience International Ltd.

By: /s/ Tom Lin

Name: Tom Lin

Title: Director

---

[Share Purchase Agreement]

IN WITNESS WHEREOF, the parties hereto have caused their respective duly authorized representatives to execute this Agreement on the date and year first above written.

INVESTORS:

By: /s/ Cheng-Chao Sung  
Name: Cheng-Chao Sung  
ID: #####

---

[Share Purchase Agreement]

IN WITNESS WHEREOF, the parties hereto have caused their respective duly authorized representatives to execute this Agreement on the date and year first above written.

INVESTORS:

By: /s/ Tian-Ren Huang  
Name: Tian-Ren Huang  
ID: #####

---

[Share Purchase Agreement]

IN WITNESS WHEREOF, the parties hereto have caused their respective duly authorized representatives to execute this Agreement on the date and year first above written.

INVESTORS:

By: /s/ Ching-Yu Peng  
Name: Ching-Yu Peng  
ID: #####

---

[Share Purchase Agreement]

---



**SCHEDULE I**

**SCHEDULE OF INVESTORS**

---

[Share Purchase Agreement]

**SCHEDULE II**

**ADDRESS FOR NOTICES**

---

[Share Purchase Agreement]

**SCHEDULE III**  
**LIST OF KEY EMPLOYEES**

---

[Share Purchase Agreement]

**SCHEDULE IV**  
**BANK ACCOUNT**

---

[Share Purchase Agreement]

**SCHEDULE V**

**DISCLOSURE SCHEDULE**

---

[Share Purchase Agreement]

**EXHIBIT A-1**

**FORM OF SECOND AMENDED AND RESTATED MEMORANDUM OF ASSOCIATION**

---

[Share Purchase Agreement]

EXHIBIT A-2

FORM OF SECOND AMENDED AND RESTATED ARTICLES OF ASSOCIATION

---

[Share Purchase Agreement]

**EXHIBIT B**

**FORM OF AMENDED AND RESTATED SHAREHOLDERS AGREEMENT**

---

[Share Purchase Agreement]



CERTAIN CONFIDENTIAL INFORMATION CONTAINED IN THIS DOCUMENT, MARKED BY [\*\*\*], HAS BEEN OMITTED BECAUSE IT IS NOT MATERIAL AND WOULD LIKELY CAUSE COMPETITIVE HARM TO THE COMPANY IF PUBLICLY DISCLOSED

**EXCLUSIVE LICENSE AGREEMENT**

AGREEMENT, dated September 13, 2016 (the "Effective Date"), between THE TRUSTEES OF COLUMBIA UNIVERSITY IN THE CITY OF NEW YORK, a New York corporation ("Columbia"), and Lin Biosciences, Inc., a Taiwanese corporation ("Company").

WHEREAS, Columbia possesses intellectual property rights related to the Patents, Materials, and Technical Information as defined herein;

WHEREAS, Company desires to license such intellectual property rights to pursue the development of Products as defined herein;

WHEREAS, Columbia is the recipient of NIH Grant Award U01NS074476 entitled "SMALL MOLECULE DRUGS FOR TREATMENT OF DRY AGE-RELATED MACULAR DEGENERATION" and directed by Columbia's employee Konstantin Petrukhin (the "Investigator") (the "Grant") under which such grant significant resources are being brought to bear to advance the Products through early clinical development;

1. Definitions.

a. "Affiliate" shall mean any corporation or other entity that directly or indirectly controls, is controlled by, or is under common control with, another corporation or entity. Control means direct or indirect ownership of, or other beneficial interest in, more than fifty percent (50%) of the voting stock, other voting interest, or income of a corporation or other entity.

b. "Generic Product" refers to a product having the same or substantially same active pharmaceutical ingredient of the Patent Product that obtained a marketing approval by means of a procedure for establishing equivalence to the Patent Product under a 21 U.S.C. Section 355(b)(2) filing in the United States or any substantially equivalent procedures in any foreign countries.

c. "Cover" or "Covered By" shall mean (i) infringes, in the case of a claim in an issued patent, or (ii) would infringe the claim if it existed in an issued patent, in the case of a claim in a pending application provided however if a pending application has not been granted within five (5) years of the first substantive patent office action considering the patentability of any claim by the relevant patent office in the country or territory in which such application is pending (after which time such pending application shall cease to Cover a product or service for purposes of this Agreement and shall have no impact under this Agreement unless and until such former pending application becomes an issued application).

---

d. "Designee" shall mean a corporation or other entity that is employed by, under contract to, or in partnership with (i) Company, (ii) a Sublicensee, (iii) an Affiliate of Company or (iv) an Affiliate of a Sublicensee, wherein such corporation or other entity is granted the right to make, use, sell, promote, distribute, market, import, or export Products.

e. "Field" shall mean all uses including all ocular indications except diabetic retinopathy, which shall included but is not limited to Dry Age Related Macular Degeneration and Stargardt Disease. Columbia will notify Company within twelve months of the Effective Date whether diabetic retinopathy could be added to the Field.

f. "License Year" shall mean the one year period from the Effective Date of this Agreement or an anniversary thereof to the next anniversary of the Effective Date.

g. "Materials" shall mean the tangible physical material, if any, delivered to Company hereunder, any progeny thereof developed by Company, its Affiliates or Sublicensees, and any derivatives thereof developed by Company, its Affiliates or Sublicensees that are not Covered By the Patents. Any Materials delivered to Company hereunder shall be listed in Exhibit B hereto.

h. "Net Sales" shall mean the greater of the gross invoice or contract price charged to Third Party customers for the Product or the actual consideration paid by Third Party customers for the Product. For all Products used or consumed by any Third Party, Company shall be entitled to deduct [\*\*\*] from Net Sales in lieu of all other deductions such as taxes, shipping charges, allowances, and the like prior to calculating royalties due. The intent of this definition of Net Sales is to allow Columbia to derive a royalty on the end sale of a Product to the first Third Party.

If a Product is sold as part of a Combination Product, the Net Sales of such Product for the purpose of calculating royalties and sales-based milestones owed under this Agreement for sales of such Product, shall be determined as follows: first, Company shall determine the actual Net Sales of such Combination Product (using the above provisions) and then such amount shall be multiplied by the fraction  $A/(A+B)$ , where A is the invoice price of such Product, if sold separately, and B is the aggregate invoice price of each other drug, device, or biological product in the Combination Product, if sold separately. If any other drug, device, or biological product in the Combination Product is not sold separately in a country, Net Sales for such country shall be calculated by multiplying actual Net Sales in such country of such Combination Product by a fraction  $A/C$  where A is the invoice price of such Product if sold separately, and C is the invoice price of the Combination Product. If neither Product nor any other drug, device, or biological product in the Combination Product is sold separately, the adjustment to Net Sales shall be determined by the Parties in good faith to reasonably reflect the fair market value of the contribution of such Product in the Combination Product to the total fair market value of such Combination Product. **Combination Product** means: (a) a product consisting of one or more products that are separately sold that are packaged together with a Product and after such packaging are sold as a single package or as a unit for a single price; or (b) a drug, device or biological product packaged and sold separately that is sold as a unit with a Product for a single price.

In the case of transfers of Products between any of Company, Sublicensees, Designees, and Affiliates of any of the foregoing, for subsequent sale, rental, lease or other transfer of such Products to Third Parties, Net Sales shall be the greater of (i) the actual amount charged for the transfer of the Product between any of Company, Sublicensees, Designees, and Affiliates of any of the foregoing and (ii) the gross invoice or contract price charged to the Third Party customer for that Product in an arms-length transaction.

The transfer of Products between any of Company, Sublicensees, Designees, and Affiliates of any of the foregoing, for humanitarian or compassionate use or for use in clinical trials or research whereby Company, Sublicensees, Designees, and Affiliates of any of the foregoing will not receive any monetary value for such Product will not be included in the calculation of Net Sales.

i. "Other Product" shall mean any product or service (or component thereof), other than a Patent Product, the discovery, development, manufacture, use, sale, offering for sale, importation, exportation, distribution, rental or lease of uses or incorporates, in whole or in part, of Materials or Technical Information.

j. "Patent" or "Patents" shall mean: (i) the United States and foreign patents and/or patent applications listed in Exhibit A hereto; (ii) any non-provisional patent applications that claim priority to any provisional patent applications listed in Exhibit A hereto; (iii) any and all claims of continuation-in-part applications that claim priority to the United States patent applications listed in Exhibit A, but only where such claims are directed to inventions disclosed in the manner provided in the first paragraph of 35 U.S.C. Section 112 in the United States patent applications listed in Exhibit A and such claims in any patents issuing from such continuation-in-part applications; (iv) any and all foreign patent applications, foreign patents or related foreign patent documents that claim priority to the patents and/or patent applications listed in Exhibit A; (v) any and all divisionals, continuations, reissues, re-examinations, renewals, substitutions, and extensions of the foregoing; and (vi) any and all patents issuing from the foregoing. Notwithstanding the preceding definition, Patent and Patents shall not include any patents or patent applications based on research conducted after the Effective Date, except as otherwise agreed in a separate writing.

k. "Patent Product" shall mean any product or service (or component thereof) the discovery, development, manufacture, use, sale, offering for sale, importation, exportation, distribution, rental or lease of which is Covered By a claim of a Patent.

l. "Phase I" shall mean, with respect to a clinical trial conducted pursuant to an IND, any controlled human clinical trial conducted in the United States as required under and pursuant to 21 C.F.R. §312.21(a), or, with respect to a jurisdiction other than the United States, a similar clinical study.

m. "Phase II" shall mean, with respect to a clinical trial conducted pursuant to an IND, any controlled human clinical trial conducted in the United States as required under and pursuant to 21 C.F.R. §312.21(b), or, with respect to a jurisdiction other than the United States, a similar clinical study.

n. "Phase III" shall mean, with respect to a clinical trial conducted pursuant to an IND, any controlled human clinical trial conducted in the United States as required under and pursuant to 21 C.F.R. §312.21(c), or, with respect to a jurisdiction other than the United States, a similar clinical study.

o. "Priority Review Voucher" means a priority review voucher for a Product awarded by FDA pursuant to Section 524 or Section 529 of the Federal Food, Drug and Cosmetic Act ("FDCA").

p. "Priority Review Voucher Revenue" means any consideration actually received by Company or its Affiliates or a Sublicensee from a Third Party solely as consideration for a Priority Review Voucher Sale to such Third Party,

q. "Priority Review Voucher Sale" means the sale by the Company or Sublicensee or an Affiliate or Designee of the foregoing of a Priority Review Voucher to a Third Party where such sale is not in connection with the sale or transfer of other assets relating to a Product or as part of a Change of Control of Company or its Affiliates.

r. "Product" or "Products" shall mean a Patent Product and/or an Other Product.

s. "Regulatory Approval" shall mean approval by the FDA of (i) a New Drug Application as described in 21 C.F.R. § 314.50 et seq., or (ii) a 510(k) or PMA application (each as described in 21 C.F.R. § 800 et seq.) or an equivalent approval in a jurisdiction outside of the United States.

t. "Regulatory Exclusivity Product" shall mean, with respect to a Product in a country in the Territory, that Company has been granted the exclusive legal right by a regulatory authority in such country to market and sell the Product in such country.

u. "Sublicensee" shall mean any third party to whom Company has granted a sublicense pursuant to this Agreement. An Affiliate of Company exercising rights hereunder shall not be considered a Sublicensee.

vu. "Technical Information" shall mean any know-how, technical information and data developed by Columbia by Dr. Petrukhin prior to the Effective Date and provided to Company by Columbia, which know-how, technical information and data are necessary or useful for the discovery, development, manufacture, use, sale, offering for sale, importation, exportation, distribution, rental or lease of a Product, including, without limitation, (i) any know-how, technical information and data disclosed in any Patent or (ii) any reports or disclosures concerning research or inventions provided or disclosed to, or otherwise received by, Company. Technical Information shall include, but is not limited to, the information set forth in Exhibit C hereto.

w. "Territory" shall mean worldwide.

x. "Third Party" shall mean any entity or person other than Company, Sublicensees, Designees, or their Affiliates.

2. License Grant.

a. Columbia grants to the Company and any Affiliate thereof, upon and subject to all the terms and conditions of this Agreement (including Section 3 hereof):

(i) an exclusive license under the Patents to discover, develop, manufacture, have made, use, sell, offer to sell, have sold, import, export, distribute, rent or lease Products in the Field and throughout the Territory;

(ii) an exclusive license to use Technical Information to discover, develop, manufacture, have made, use, sell, offer to sell, have sold, import, export, distribute, rent or lease Products in the Field and throughout the Territory until such time as Technical Information is published or otherwise publicly distributed and, thereafter, the license granted hereunder shall automatically convert to a non-exclusive license; provided however, that Columbia and its faculty and employees shall have the right to publish, disseminate or otherwise disclose the Technical Information; and

(iii) an exclusive license to use Materials to discover, develop, manufacture, have made, use, sell, offer to sell, have sold, import, export, distribute, rent or lease Products in the Field and throughout the Territory.

b. Columbia grants to Company the right to grant sublicenses after completion of [\*\*\*] of a Product, provided that: (i) the Sublicensee agrees to abide by and be subject to all the terms and provisions of this Agreement applicable to the Company; (ii) the Sublicensee shall have no further right to grant sublicenses under this Agreement; (iii) in the event any Sublicensee (or any entity or person acting on its behalf) initiates any proceeding or otherwise asserts any claim challenging the validity or enforceability of any Patent in any court, administrative agency or other forum, Company shall, upon written request by Columbia, terminate forthwith the sublicense agreement with such Sublicensee, (provided such is a legally available remedy) and the sublicense agreement shall provide for such right of termination by Company (provided such is a legally available remedy); (iv) the sublicense agreement shall provide that, in the event of any inconsistency between the sublicense agreement and this Agreement, this Agreement shall control; (v) the Sublicensee will submit quarterly reports to Company consistent with the reporting provision of Section 5a herein; (vi) Company remains fully liable for the performance of its and its Sublicensee's obligations hereunder; (vii) Company notifies Columbia of any proposed grant of a sublicense and provides to Columbia, upon request, a copy of any sublicense agreement thirty (30) business days after the execution thereof, which agreement shall be confidential information of the Company; and (viii) no such sublicense or attempt to obtain a sublicense shall relieve Company of its obligations under Section 6 hereof to exercise its own commercially reasonable efforts, directly or through a sublicense, to discover, develop and market Products, nor relieve Company of its obligations to pay Columbia any and all license fees, royalties and other payments due under the Agreement, including but not limited to under Sections 4, 5 and 11 of the Agreement.

c. Company hereby agrees and covenants, in consideration of the rights granted to it under this Agreement, not to sue, or otherwise claim or seek to enforce any of the Patents against the Third Party sponsoring research at Columbia utilizing the Patents in the field of diabetic retinopathy ("Authorized Third Party"), with respect to Authorized Third Party's development, manufacture, use, sale, import, distribution, rental, lease or any other practice of the compounds disclosed and claimed in the Patents in the field of diabetic retinopathy.

d. All rights and licenses granted by Columbia to Company under this Agreement are subject to (i) any limitations imposed by the terms of any government grant, government contract or government cooperative agreement applicable to the technology that is the subject of this Agreement, and (ii) applicable requirements of 35 U.S.C. Sections 200 et seq., as amended, and implementing regulations and policies. Without limitation of the foregoing, Company agrees that, to the extent required under 35 U.S.C. Section 204, any Product used, sold, distributed, rented or leased by Company, Sublicensees, Designees, and their Affiliates in the United States will be manufactured substantially in the United States. In addition, Company agrees that, to the extent required under 35 U.S.C. Section 202(c)(4), the United States government is granted a nonexclusive, nontransferable, irrevocable, paid-up license to practice or have practiced for or on behalf of the United States any Patent throughout the world.

e. All rights not specifically granted herein are reserved to Columbia. Except as expressly provided under this Section 2, no right or license is granted (expressly or by implication or estoppel) by Columbia to Company or its Affiliates or Sublicensees under any tangible or intellectual property, materials, patent, patent application, trademark, copyright, trade secret, know-how, technical information, data or other proprietary right.

3. Reservation of Rights for Research Purposes: Freedom of Publication.

a. Columbia reserves the right to practice the Patents and use Materials, to the extent Patents and Materials are exclusively licensed hereunder, for academic research and educational purposes in the Field and to permit other non-profit entities or individuals to practice and use such Patents and Materials for academic research and educational purposes in the Field provided that in no event shall such Technical Information, Materials or Patents be used in connection with any research sponsored by a third party commercial entity entered into after the Effective Date. Company acknowledges that as of the Effective Date, the Authorized Third Party is sponsoring research at Columbia utilizing the Patents and Materials in the field of diabetic retinopathy. Columbia shall obtain from all entities or individuals who are given permission to practice and use such Patents and Materials an agreement in writing to limit such use to academic research and educational purposes. Nothing in this Agreement shall be interpreted to limit in any way the right of Columbia and its faculty or employees to practice and use such Patents and Materials for any purpose outside the Field or to license or permit such use outside the Field by third parties.

b. Company acknowledges that Columbia is dedicated to free scholarly exchange and to public dissemination of the results of its scholarly activities. Columbia and its faculty and employees shall have the right to publish, disseminate or otherwise disclose any information relating to its research activities, including Technical Information.

4. Fees, Royalties and Payment.

a. Importance of Technical Information and Materials. Company has requested, and Columbia has agreed, to grant certain rights to Technical Information and Materials. Company requires these rights in order to develop and commercialize the technology licensed hereunder. Because of the importance of Technical Information and Materials, Company has agreed to pay certain royalties to Columbia on Other Products, as specified herein, even if it is not Covered By a Patent, in order to obtain rights to Technical Information and Materials. Company has agreed to these payments because of the commercial value of Technical Information and Materials, separate and distinct from the commercial value of the Patents. Company acknowledges that it would not have entered into this Agreement without receiving the rights to the Technical Information and Materials specified in Section 2. Company further acknowledges that licenses to Technical Information, Materials, and each patent and application within the definition of Patents were separately available from a license to the Patents, and that for convenience and because of the preference of Company, the parties executed a combined license to the Patents, Technical Information, and Materials.

b. In consideration of the licenses granted under Section 2a of this Agreement, the Company shall pay to Columbia as follows:

Agreement

(i) License Fee: A nonrefundable, non-recoverable and non-creditable license fee in the sum of \$2,500,000.00, payable within ninety days after execution of this

(ii) Royalties:

recoverable royalty of:

(A) With respect to sales of Products by Company or Sublicensee, their Designees or their Affiliates, in the Territory, a nonrefundable and non-

(1) [\*\*\*] on Net Sales of Patent Products; and

(2) [\*\*\*] on Net Sales of Regulatory Exclusive Products; and

(3) [\*\*\*] on Net Sales of Other Products.

In the event that a Generic Product is available in a certain country, the royalties set forth in Section 4b will be reduced to [\*\*\*] in such country for the Product referenced by the Generic Product.

(B) Notwithstanding the foregoing, commencing on the second anniversary of the commercial launch of any Product, the Company shall pay to Columbia a nonrefundable and non-recoverable minimum royalty payment as follows: (i) [\*\*\*], payable annually within [\*\*\*] following the [\*\*\*] of the first bona fide commercial sale of a Product by Company, a Sublicensee, a Designee, or any of their Affiliates, to a Third Party customer (the "First Commercial Sale"), and (ii) [\*\*\*] payable [\*\*\*] on the first business day of [\*\*\*] following the [\*\*\*] anniversary of the First Commercial Sale and every anniversary thereafter until the end of the royalty term as specified in Section 16b. Each such minimum royalty payment will be credited against earned royalties accrued during the same calendar year in which the minimum royalty payment is due and payable. To the extent minimum royalty payments exceed the earned royalties accrued during the same calendar year, this excess amount cannot be carried over to any other year, either to decrease the earned royalties due in that year or to decrease the minimum royalty payments due in that year.

c. In consideration of Company's right to sublicense third parties granted under Section 2b of this Agreement, Company shall pay to Columbia the following nonrefundable, non-recoverable and non-creditable amounts (the intention of the parties being that Columbia shall receive consideration equivalent to a full pass-through royalty on all sales of Products by Sublicensees as set forth in Section 4b(ii)(A)):

(i) Other Payments: [\*\*\*] of any and all other gross revenues (excluding royalties), fees, payments and consideration (including a portion of any equity securities of any cross-licensing rights granted by Sublicensee to Company), including without limitation, any upfront, milestone or lump sum payments, received by Company from Sublicensees, their Designees or their Affiliates as full or partial consideration for the grant of any sublicense by Company pursuant to Section 2b of this Agreement but shall not include (a) for research and development conducted as agreed with the Sublicensee and conducted after the date on which the Sublicensee actually signed the sublicense agreement and which payments are not in excess of Company's fully burdened costs, fees, expenses, and royalties related to performing any research and development relating to the Products, (b) any consideration received for an equity interest in, extension of credit to or other investment in Company or its Affiliates to the extent such consideration does not exceed [\*\*\*] of fair market value of the equity or other interest received as determined by agreement of the parties or by an independent appraiser mutually agreeable to the parties, or (c) the receipt of any equipment or the use of any real estate where such equipment or real estate is used for the mutual benefit of the Sublicensee and the Company or where the Company pays fair market value for such equipment or real estate.

(ii) Company will pay Columbia an amount equal to [\*\*\*] of Priority Review Voucher Revenue. If Company has not sold the Priority Review Voucher [\*\*\*] of receipt of the Priority Review Voucher, royalties due under Section 3b(ii)(A)1 shall [\*\*\*] of Net Sales of Patent Products.

d. Development Milestone Payments: In the event that the Company, Sublicensees, or their Affiliates (collectively "Developer") develops a Product for commercial sale in the Territory, the following nonrefundable, non-recoverable and non-creditable milestone payments shall be made by Company to Columbia with respect to the first Product as follows:

MILESTONE	PAYMENT
[***]	[***]
[***]	[***]
[***]	[***]
[***]	[***]
[***]	[***]

The above milestone payment shall be paid on the first Product and first indication only.

e. Duration of Other Product Royalties. Royalties on Other Products shall be payable on a country-by-country and product-by-product basis for the longer of [\*\*\*] years after the first bona fide commercial sale of an Other Product in a country or expiration of any market exclusivity period granted by a regulatory agency

f. Highest Royalty Due. If a Product is covered by both the definition of Patent Product, Regulatory Exclusivity Product and Other Product, but not a Generic Product, Columbia shall be entitled to the Patent Product royalty rate on the Product. Columbia shall not be entitled to more than one royalty payment on the same Product sale under Section 4. To the extent a Product ceases being a Patent Product, but is still an Other Product, Columbia shall be entitled to the Other Product royalty rate on the Product, but only for such time as specified in Section 4e. By way of example, but not by way of limitation, if the manufacture of a Product is Covered by the claim of a Patent, and the manufacture of that Product also incorporates in part Technical Information, Company must pay the royalty specified in Section 4b(ii)(A)(1). If, after some period of time (for example, five years) of paying the royalties specified in Section 4b(ii)(A)(1) on the Product, the Product ceases to be a Patent Product, Company must continue to pay royalties on the Product pursuant to Section 4b(ii)(A)(3) for the duration specified in Section 4e measured from the first bona fide commercial sale of the Patent Product on a country-by-country and product-by-product basis.



g. No Non-Monetary Consideration. Without Columbia's prior written consent, which shall not be unreasonably withheld or delayed, Company, Sublicensees, Designees, and Affiliates of the foregoing, shall not solicit or accept any consideration for the sale of any Product other than as will be accurately reflected in Net Sales. Furthermore, Company shall not enter into any transaction with any Affiliate that would circumvent its monetary or other obligations under this Agreement.

h. Rate Adjustment on Challenge; Payment of Costs and Expenses.

(i) In the event Company (or any entity or person acting on its behalf) initiates any proceeding any claim challenging the validity or enforceability of any Patent in any court, administrative agency or other forum ("Challenge"), all royalty rates, minimum royalties, and other payment rates set forth in Sections 4b(ii) and 4c shall be automatically [\*\*\*] on and after the date of such challenge for the remaining term of this Agreement.

(ii) Company shall pay all costs and expenses incurred by Columbia (including actual attorneys' fees) in connection with defending a Challenge. Columbia may bill Company on a quarterly basis with respect to such costs and expenses, and Company shall make payment within [\*\*\*] days after receiving an invoice from Columbia.

(iii) In the event at least one claim of a Patent that is subject to a Challenge survives the Challenge by not being found invalid or unenforceable, regardless of whether the claim is amended as part of the Challenge, all royalty rates, minimum royalties, and other payment rates set forth in Sections 4b(ii) and 4c shall be [\*\*\*] on and after the date of such finding for the remaining term of this Agreement.

Company acknowledges and agrees that the provisions set forth in this Section 4h reasonably reflect the value derived from the Agreement by Company in the event of a Challenge. In addition, Company acknowledges and agrees that any payments made under this Section 4h shall be nonrefundable and non-recoverable for any reason whatsoever.

i. Sale Below Fair Market Value. In the event that Company, Sublicensees, Designees or their Affiliates sell Product to a Third Party for subsequent sale, rental, lease or other transfer to whom it also sells other products, the price for Licensed Product shall not be established such that Net Sales is below fair market value with the intent of increasing market share for other products sold by Company, Sublicensees, Designees or their Affiliates to such Third Party or for the purpose of reducing the amount of royalties payable on the Net Sales of Product. If the sale of Product under such circumstances results in Net Sales below the fair market value of Product, then the Net Sales of Product in such transaction shall be deemed to be the fair market value for purposes of calculating payments owed to Columbia under this Agreement. These provisions will not apply to the transfer of Product to a Third Party for humanitarian or compassionate use or for use in clinical trials or research whereby Company, Sublicensee or any Designee or Affiliate of any of the foregoing will not receive any monetary value for such Product.

5. Reports and Payments.

a. Within [\*\*\*] days after the first business day of each [\*\*\*] of each License Year of this Agreement, Company shall submit to Columbia a written report with respect to the preceding [\*\*\*] (the "Payment Report") stating:

(i) Gross and Net Sales of Products by Company, Sublicensees, Designees and their Affiliates during such [\*\*\*], together with detailed information sufficient to permit Columbia to verify the accuracy of reported Net Sales, including Product names, country where manufactured, country where sold, actual selling price, units sold ;

(ii) Amounts accruing to, and amounts received by, Company from its Sublicensees during such [\*\*\*] together with the respective payment reports received by Company from any Sublicensees; and

(iii) A calculation under Section 4 of the amounts due to Columbia, making reference to the applicable subsection thereof.

b. Simultaneously with the submission of each Payment Report, Company shall make payments to Columbia of the amounts due for the [\*\*\*] covered by the Payment Report. Payment shall be by check payable to The Trustees of Columbia University in the City of New York and sent to the following address:

The Trustees of Columbia University in the City of New York  
Columbia Technology Ventures  
P.O. Box 1394  
New York, NY 10008-1394

or to such other address as Columbia may specify by notice hereunder, or if requested by Columbia, by wire transfer of immediately available funds by Company to:

[\*\*\*]  
**(This is the bank's address, not Columbia University's.  
Do not use this address for correspondence to Columbia University.)**  
[\*\*\*]

or to such other bank and account identified by notice to Company by Columbia. Company is required to send the [\*\*\*] royalty statement whether or not royalty payments are due.

c. Within [\*\*\*] days after the date of termination or expiration of this Agreement, Company shall pay Columbia any and all amounts that are due pursuant to this Agreement as of the date of such termination or expiration, together with a Payment Report for such payment in accordance with Section 5a hereof, except that such Payment Report shall cover the period from the end of the last [\*\*\*] prior to termination or expiration to the date of termination or expiration. Nothing in the foregoing shall be deemed to satisfy any of Company's other obligations under this Agreement upon termination or expiration.

d. Minimum royalty payments are payable in accordance with Section 4b(ii)(B).

e. With respect to revenues obtained by Company in foreign countries, Company shall make royalty payments to Columbia in the United States in United States Dollars. Royalty payments for transactions outside the United States shall first be determined in the currency of the country in which they are earned, and then converted to United States dollars using the buying rates of exchange quoted by The Wall Street Journal (or its successor) in New York, New York for the last business day of the [\*\*\*] in which the royalties were earned. Any and all loss of exchange value, taxes, or other expenses incurred in the transfer or conversion of foreign currency into U.S. dollars, and any income, remittance, or other taxes on such royalties required to be withheld at the source shall be the exclusive responsibility of Company, and shall not be used to decrease the amount of royalties due to Columbia. Royalty statements shall show sales both in the local currency and US dollars, with the exchange rate used clearly stated.

f. Company shall maintain at its principal office usual books of account and records showing its actions under this Agreement, and sufficient to determine Company's compliance with its obligations hereunder. Upon reasonable notice, but not more than [\*\*\*] per calendar year, Columbia may have an independent national certified public accountant or auditor, (to whom Company has no reasonable objection) inspect and copy such books and records for purposes of verifying the accuracy of the amounts paid under this Agreement. The review may cover a period of not more than [\*\*\*] years before the first day of the [\*\*\*] in which the review is requested. In the event that such review shows that Company has underpaid royalties by [\*\*\*] or more with respect to any [\*\*\*], or if such underpayment is in excess of [\*\*\*] for any [\*\*\*], or an aggregate of [\*\*\*] for any [\*\*\*], Company shall pay, within [\*\*\*] days after demand by Columbia, the costs and expenses of such review (including the fees charged by Columbia's accountant and attorney involved in the review), in addition to amount of any underpayment and any interest thereon. Company agrees to cooperate fully with the independent accountant or auditor and Columbia's in house attorney in connection with any such review. For the sake of clarity, the audit will be performed by the independent accountant or auditor. During the review, Company shall provide Columbia's accountant or auditor and in-house attorney to audit and test for completeness, including without limitation, with information relating to sales, inventory, manufacturing, purchasing, transfer records, customer lists, invoices, purchase orders, sales orders, shipping documentation, third-party royalty reports, cost information, pricing policies, and agreements with third parties (including Sublicensees, Designees, Affiliates of Company, Sublicensees and Designees, and customers) (collectively, "Company Documentation"). Columbia agrees that all Company Documentation will be reviewed by the independent accountant or auditor and Columbia's in house attorney only.

g. Notwithstanding anything to the contrary in this Agreement (including Section 15b), and without limiting any of Columbia's rights and remedies hereunder, any payment required hereunder that is made late (including unpaid portions of amounts due) shall bear interest, compounded monthly, either at the rate of [\*\*\*] per annum, or in Columbia's sole discretion, at the U.S. prime rate plus [\*\*\*] as published by the Wall Street Journal on the last day of the applicable billing period. Any interest charged or paid in excess of the maximum rate permitted by applicable New York State Law shall be deemed the result of a mistake and interest paid in excess of the maximum rate shall be credited or refunded (at the Company's option) to Company.

h. Company shall reimburse Columbia for any costs and expenses incurred in connection with collecting on any arrears of Company with respect to its payment and reimbursement obligations under this Agreement (such as Section 11b of this Agreement), including the costs of engaging any collection agency for such purpose.

6. Diligence.

a. Company shall use its commercially reasonable efforts to research, discover, develop and market a Products for commercial sale and distribution in the Field and throughout the Territory, and to such end, such efforts will include the following:

- (i) Investigational New Drug Application (IND)
  - File IND [\*\*\*] of receiving final study report on GLP toxicity studies (Company as Sponsor)
- (ii) Phase I Clinical Trials
  - MAD Phase trial (normal volunteers) completed [\*\*\*]
  - Phase Ib trial in Stargardt patients and/or elderly individuals completed [\*\*\*] (may be combined with Phase II for Starbardt disease)
- (iii) Phase II/III Clinical Trials
  - Complete recruitment of [\*\*\*]
  - Complete [\*\*\*] Phase II/III in Stargardt Disease [\*\*\*]
  - Complete recruitment of Phase II clinical trial in Dry AMD [\*\*\*]
  - Complete Phase II clinical trial in Dry AMD [\*\*\*]
  - Complete recruitment of Phase III clinical trial in Dry AMD [\*\*\*]
  - Complete Phase III clinical trial in Dry AMD [\*\*\*]
- (iv) Regulatory Approval
  - Obtain Regulatory Approval in Stargardt Disease [\*\*\*]
  - Obtain Regulatory Approval in Dry AMD [\*\*\*]

b. In the event that Company is unable to achieve a particular milestone set forth in Section 6a, Company will notify Columbia and upon payment of a [\*\*\*] fee, Columbia will agree to a [\*\*\*] extension of the due date for such milestone. In the event after completion of Phase I Trials (as per Section 6a(ii)) there are unforeseen changes in clinical or regulatory development that Company believes would affect the timely achievement of any milestone, Company may request an extension from Columbia for such milestone, which will not be unreasonably withheld or delayed. Notwithstanding any other provisions of this Agreement, failure to achieve any of Company's diligence obligations under this Section shall result in Columbia having the option of terminating all of the licenses granted under Section 2 in accordance with Section 16 of this Agreement, or converting any or all of such exclusive licenses to non-exclusive licenses with no right to sublicense and no right to initiate legal proceedings pursuant to Section 11.

i. No less often than every six (6) months after the Effective Date of this Agreement, Company shall report in writing to Columbia on progress made toward the diligence objectives set forth above.

7. Confidentiality.

a. Except to the extent required to discover, develop, manufacture, use, sell, have sold, distribute, rent or lease Products in the Field, each Party will treat as confidential any Confidential Information disclosed hereunder, and will not disclose or distribute the same to any third party without the discloser's written permission.

b. The obligations of confidentiality under this Section 7 do not apply to any Confidential Information that Company can demonstrate:

(i) was known to recipient prior to receipt thereof from discloser;

(ii) was or becomes a matter of public information or publicly available through no act or failure to act on the part of recipient;

(iii) is acquired by recipient from a third party not bound by a confidentiality obligation with respect to the Discloser's Confidential Information; or

(iv) Recipient discovers, develops independently without reference to or use of such Confidential Information, as evidenced by contemporaneous written records.

Notwithstanding the foregoing, either Party to this Agreement shall have the right to disclose such Confidential Information pursuant to (i) a judicial order issued by a court of competent jurisdiction, (ii) other valid and binding court ordered discovery, (iii) lawful governmental order or (iv) law, regulation or rule (including, without limitation, the Securities Exchange Act of 1934, as amended or any foreign equivalent) or the rules of any applicable exchange on which any shares are listed, but only to the extent so ordered, provided, however, that in each case the Party so ordered or obligated shall notify the other Party to this Agreement, in writing, of such pending action to compel disclosure or such order in sufficient time to permit adequate time for response by the affected Party. The Recipient shall provide all reasonable assistance, at the Disclosing Party's expense and direction, in opposing such disclosure order.

8. Disclaimer of Warranty; Limitations of Liability.

a. COLUMBIA IS LICENSING THE PATENTS, MATERIALS, TECHNICAL INFORMATION, AND THE SUBJECT OF ANY OTHER LICENSE HEREUNDER, ON AN "AS IS" BASIS. COLUMBIA MAKES NO WARRANTIES EITHER EXPRESS OR IMPLIED OF ANY KIND, AND HEREBY EXPRESSLY DISCLAIMS ANY WARRANTIES, REPRESENTATIONS OR GUARANTEES OF ANY KIND AS TO THE PATENTS, MATERIALS, TECHNICAL INFORMATION, PRODUCTS AND/OR ANYTHING DISCOVERED, DEVELOPED, MANUFACTURED, USED, SOLD, OFFERED FOR SALE, IMPORTED, EXPORTED, DISTRIBUTED, RENTED, LEASED OR OTHERWISE DISPOSED OF UNDER ANY LICENSE GRANTED HEREUNDER, INCLUDING BUT NOT LIMITED TO: ANY WARRANTIES OF MERCHANTABILITY, TITLE, FITNESS, ADEQUACY OR SUITABILITY FOR A PARTICULAR PURPOSE, USE OR RESULT; ANY WARRANTIES AS TO THE VALIDITY OF ANY PATENT; AND ANY WARRANTIES OF FREEDOM FROM INFRINGEMENT OF ANY DOMESTIC OR FOREIGN PATENTS, COPYRIGHTS, TRADE SECRETS OR OTHER PROPRIETARY RIGHTS OF ANY PARTY.

b. In no event shall Columbia, or its trustees, officers, faculty members, students, employees and agents, have any liability to Company, Sublicensees, Designees, or Affiliates of the foregoing, or any Third Party arising out of the use, operation or application of the Patents, Technical Information, Materials, Products, or anything discovered, developed, manufactured, used, sold, offered for sale, imported, exported, distributed, rented, leased or otherwise disposed of under any license granted hereunder by Company, Sublicensees, Designees or Affiliates of the foregoing, or any Third Party for any reason, including but not limited to, the unmerchantability, inadequacy or unsuitability of the Patents, Materials, Technical Information, Products and/or anything discovered, developed, manufactured, used, sold, offered for sale, imported, exported, distributed, rented, leased or otherwise disposed of under any license granted hereunder for any particular purpose or to produce any particular result, or for any latent defects therein except in the case where such liability is the direct result of Columbia's gross negligence or intentional misconduct.

c. In no event will Columbia, or its trustees, officers, faculty members, students, employees and agents, be liable to the Company, Sublicensees, Designees or Affiliates of the foregoing, or any Third Party, for any consequential, incidental, special or indirect damages (including, but not limited to, from any destruction to property or from any loss of use, revenue, profit, time or good will) based on activity arising out of or related to this Agreement, whether pursuant to a claim of breach of contract or any other claim of any type except in the case where such damages are the direct result of Columbia's gross negligence or intentional misconduct.

d. In no event shall Columbia's liability to Company exceed the payments made to Columbia by Company under this Agreement.

e. The parties hereto acknowledge that the limitations and exclusions of liability and disclaimers of warranty set forth in this Agreement form an essential basis of the bargain between the parties.

9. Prohibition Against Use of Columbia's Name.

Company will not use the name, insignia, or symbols of Columbia, its faculties or departments, or any variation or combination thereof, or the name of any trustee, faculty member, other employee, or student of Columbia for any purpose whatsoever without Columbia's prior written consent except to state that the patents are licensed from Columbia and as otherwise required by law, regulation, directive, treaty or order or subpoena, including under securities laws or regulations or other rules of any exchange on which securities are traded.

10. Compliance with Governmental Obligations.

a. Notwithstanding any provision in this Agreement, Columbia disclaims any obligation or liability arising under the license provisions of this Agreement if Company or its Affiliates is charged in a governmental action for not complying with or fails to comply with governmental regulations in the course of taking steps to bring any Product to a point of practical application.

b. Company and its Affiliates shall comply upon reasonable notice from Columbia with all governmental requests directed to either Columbia or Company or its Affiliates and provide all information and assistance necessary to comply with the governmental requests.

c. Company and its Affiliates shall ensure that research, development, manufacturing and marketing under this Agreement complies with all government regulations in force and effect including, but not limited to, Federal, state, and municipal legislation.

11. Patent Prosecution and Maintenance: Litigation.

a. Columbia, by counsel it selects to whom Company has no reasonable objection, in consultation with Company and any counsel appointed by the Company, will prepare, file, prosecute and maintain all Patents in Columbia's name and in countries designated by the Company. Columbia shall instruct its patent counsel (1) to copy Company on all correspondence related to Patents (including copies of each patent application, office action, response to office action, request for terminal disclaimer, and request for reissue or reexamination of any patent or patent application) and (2) as requested by Company, to provide an update as to the current status of all Patents. The parties agree that consultation between the parties relating to the Patents under this Section 11 shall be pursuant to a common interest in the validity, enforceability and scope of the Patents. Each party shall treat such consultation, along with any information disclosed by each party in connection therewith (including any information concerning patent expenses), on a strictly confidential basis, and shall not disclose such consultation or information to any party without the other party's prior written consent. If Company seeks to challenge the validity, enforceability or scope of any Patent, Columbia's consultation obligation under this Section 11a shall automatically terminate; for the avoidance of doubt, any such termination shall not affect Company's confidentiality and nondisclosure obligations with respect to consultation or disclosure of information prior to such termination, and shall not affect any other provisions of this Agreement (including Company's reimbursement obligation under Section 11b).

b. Company will reimburse Columbia for the actual fees, costs, and expenses Columbia has incurred prior to [\*\*\*] not to exceed [\*\*\*] upon receiving Columbia's itemized invoices and will pay the actual fees, costs, and expenses that Columbia incurs following [\*\*\*] in preparing, filing, prosecuting and maintaining the Patents and those past patent expenses Columbia incurred prior to [\*\*\*] relating to the following patents and patent applications to which Patents claim priority, issue fees, working fees, maintenance fees and renewal charges (collectively "Patent Expenses"). Columbia, using reasonable efforts, estimates that unreimbursed patent expenses incurred through [\*\*\*] upon receiving Columbia's itemized invoices under Section 11a in connection with the Patents set forth in Exhibit A are \$ [\*\*\*], and shall be reimbursed in full by Company to Columbia within seven (7) business days after the Effective Date and receiving Columbia's itemized invoice. Patent Expenses incurred by Columbia after [\*\*\*] shall be reimbursed to Columbia by Company within fourteen (14) days of receiving Columbia's itemized invoice. Pursuant to Section 1(e), should the diabetic retinopathy indication be licensed to another party, Columbia agrees to provide a reduction on a pro rata credit basis of the patent expenses to the Company. However, at Columbia's election, Columbia may require advance payment of a reasonable estimate of future Patent Expenses, and Columbia may require the Company to make such payment up to three months prior to the date Columbia has chosen for the legal work to be completed. In any event, Columbia will give at least 14 days' notice to the Company prior to the date the advance payment is due. Any unused balance, if any, will be credited towards future Patent Expenses, or upon Company's written request, returned to the Company. Within fourteen (14) days of receiving an invoice from Columbia for any Patent Expenses incurred in excess of the reasonable estimate, Company shall reimburse Columbia for such excess amount. Upon failure of Company to pay Patenting Expenses for any Patent(s) as required by this Section 11b, Columbia may abandon any said Patent(s) in its sole discretion. In such event, Columbia will provide notice of abandonment to Company.

c. Subject to Sections 11d and 11f, Columbia shall have the sole right to initiate, control, defend and/or settle any proceedings involving the validity, enforceability or infringement of any Patents when in its sole judgment such action may be necessary, proper, and justified.

d. Upon written notice to Columbia, Company may request that Columbia take steps to stop a third party who is selling a product that does or will compete with a Product sold or being developed by Company or any of its Affiliates (but not a Sublicensee, or Sublicensee Affiliate) ("Third Party Infringer") from infringing an issued patent falling within the definition of Patents by providing Columbia with written evidence demonstrating prima facie infringement of specific claims of such Patent. Company shall have the right to initiate legal proceedings against any such Third-Party Infringer in its own name and at Company's sole expense, unless Columbia, not later than ninety (90) days after receipt of such notice, either (i) causes such infringement to cease or (ii) initiates legal proceedings against the Third-Party Infringer. Company will provide all assistance reasonably requested by Columbia and will not make any admission or assert any position in any legal or administrative proceeding that is inconsistent with or adverse to any position asserted by Columbia in any proceedings against the Third-Party Infringer, without Columbia's prior written consent. Notwithstanding the foregoing, Columbia shall have no obligation to assert more than one Patent in one jurisdiction against the Third-Party Infringer. In the event that Columbia does not cause infringement to cease or fails to initiate legal proceedings as set forth above and Company initiates legal proceedings against the Third-Party Infringer, Columbia will join the action as a co-plaintiff if the court determines that Columbia is an essential party to the action. Any proposed disposition or settlement of a legal proceeding filed by Company to enforce any issued patent falling within the definition of Patents against any Third-Party Infringer shall be subject to Columbia's prior written approval, which approval shall not be unreasonably withheld or delayed. Notwithstanding the foregoing, Company's rights under this Section 11d shall apply only to claims of Patents that are exclusively licensed to Company under this Agreement and only in the Field and Territory which are exclusively licensed to Company under this Agreement.



e. Any recovery, whether by way of settlement or judgment, from a third party pursuant to a legal proceeding initiated in accordance with Section 11d shall first be used to reimburse the party initiating such legal proceeding for its actual fees, costs and expenses incurred in connection with such proceeding. Any remaining amounts from any such settlement or judgment shall be divided as follows: (A) Columbia shall retain or receive, as applicable, the royalty that it would have otherwise received under Section 4b(ii) had such activities been performed by Company, and (B) all other such amounts (including any punitive or exemplary damages) shall be divided [\*\*\*] to the party who initiated or carried on the proceedings and [\*\*\*] to the other party.

f. In the event a party initiates or defends a legal proceeding concerning any Patent pursuant to Section 11, the other party shall cooperate fully with and supply all assistance reasonably requested by the party initiating such proceeding, including without limitation, joining the proceeding as a party if requested. The party that institutes any legal proceeding concerning any Patent pursuant to Section 11 shall have sole control of that proceeding.

12. Indemnity and Insurance.

a. Company will indemnify, defend, and hold harmless Columbia, its trustees, officers, faculty, employees, students and agents, from and against any and all actions, suits, claims, demands, prosecutions, liabilities, costs, expenses, damages, deficiencies, losses or obligations (including attorneys' fees) based on, arising out of, or relating to this Agreement, including, without limitation (collectively the "Claims"), (i) the discovery, development, manufacture, packaging, use, sale, offering for sale, importation, exportation, distribution, rental or lease of Products, even if altered for use for a purpose not intended, (ii) the use of Patents, Materials or Technical Information by Company, Sublicensees, Designees, or their Affiliates or customers, (iii) any representation made or warranty given by Company, Sublicensees, Designees, or their Affiliates with respect to Products, Patents, Materials or Technical Information, (iv) any infringement claims relating to Products, Patents, Materials or Technical Information, and (v) any asserted violation of the Export Laws (as defined in Section 14 hereof) by Company, Sublicensees, Designees, or their Affiliates, except that Company shall not be required to indemnify Columbia if the Claims are the direct result of Columbia's gross negligence or willful misconduct. Company shall reimburse Columbia for the actual fees, costs, and expenses (including attorneys' fees) that it may incur in enforcing this provision.

b. Company shall maintain, during the term of this Agreement, commercial general liability insurance (including product liability and contractual liability insurance applicable to Company's indemnity obligations under Section 12a) with reputable and financially secure insurance carriers reasonably acceptable to Columbia to cover the activities of Company, Sublicensees, Designees, and their Affiliates, for minimum limits of [\*\*\*] combined single limit for bodily injury and property damage per occurrence and in the aggregate. Such insurance shall include Columbia, its trustees, faculty, officers, employees and agents as additional insureds. Company shall furnish a certificate of insurance evidencing such coverage, with thirty days' written notice to Columbia of cancellation or material change in coverage. The minimum amounts of insurance coverage required herein shall not be construed as creating any limitation on the Company's indemnity obligation under Section 12a of this Agreement.

c. Company's insurance shall be primary coverage; any insurance Columbia may purchase shall be excess and noncontributory. The Company's insurance shall be written to cover claims incurred, discovered, manifested, or made during or after the expiration of this Agreement.

d. Company shall at all times comply with all statutory workers' compensation and employers' liability requirements covering its employees with respect to activities performed under this Agreement.

13. Marking.

Prior to the issuance of patents falling within the definition of Patents, Company shall mark all Patent Products, where reasonably practicable, made, sold, offered for sale, imported, or otherwise disposed of by Company under the license granted in this Agreement with the words "Patent Pending," and following the issuance of one or more patents, with the numbers of such patents. The Company shall cause its Affiliates, and its Sublicensees and Designees and their Affiliates, to comply with the marking requirements of this Section 13 where reasonably practicable.

14. Export Control Laws.

Company agrees to comply with U.S. export laws and regulations pertaining to the export of technical data, services and commodities, including the International Traffic in Arms Regulations (22 C.F.R. § 120 et seq.), the Export Administration Regulations (15 C.F.R. § 730 et seq.), the regulations administered by the Treasury Department's Office of Foreign Assets Control (31 C.F.R. § 500, et seq.), and the Anti-Boycott Regulations (15 C.F.R. § 760). The parties shall cooperate with each other to facilitate compliance with these laws and regulations.

Company understands that sharing controlled technical data with non-U.S. persons is an export to that person's country of citizenship that is subject to U.S. export laws and regulations, even if the transfer occurs in the United States. Company shall obtain any necessary U.S. government license or other authorization required pursuant to the U.S. export control laws and regulations for the export or re-export of any commodity, service or technical data covered by this Agreement, including technical data acquired from Columbia pursuant to this Agreement and products created as a result of that data.

15. Breach and Cure.

a. In addition to applicable legal standards, Company shall be deemed to be in material breach of this Agreement for: (i) failure to pay fully and promptly amounts due pursuant to Section 4 (including without limitation, the minimum royalties under subsection b(ii)(B) thereof and any payments required under subsection h thereof) and payable pursuant to Section 5; (ii) failure of Company to meet any of its obligations under Section 6 of this Agreement; (iii) failure to comply with governmental requests directed to Columbia or Company pursuant to Section 10b; (iv) failure to reimburse Columbia for or pay fully and promptly the costs of prosecuting and maintaining Patents pursuant to Section 11; (v) failure to obtain and maintain insurance in the amount and of the type provided for in Section 12; and (vi) failure to comply with the Export Laws under Section 14.

b. Either party shall have the right to cure its material breach. The cure shall be effected within a reasonable period of time but in no event later than sixty (60) days after notice of any breach given by the non-breaching party.

16. Term of Agreement.

a. This Agreement shall be effective as of the Effective Date and shall continue in full force and effect until its expiration or termination in accordance with this Section 16.

In addition, upon any termination of this Agreement pursuant to Section 16c, with respect to: (A) all know-how, technical information and data developed by Company ("Company Technical Information") during the term of this Agreement, and prior to its termination, to the extent such Company Technical Information is solely and directly related to the Company's efforts to develop Products; Columbia shall have the right to use such Company Technical Information for any purpose whatsoever on a non-exclusive basis, including the right to sublicense same to future licensees, and Company will provide Columbia (and/or its future licensees) access to any regulatory information filed or authorized by Company with any U.S. or foreign government agency with respect to such Products, and (B) all Company filed patent applications or Company obtained patents, related to any addition, development, modification and/or improvement of Products ("Company Patents"); Company hereby grants Columbia a royalty free, worldwide, non-exclusive license (together with rights to sublicense its future licensees) to make, use and sell Products under such Company Patents. Company agrees upon request, to enter into good faith negotiations with Columbia or Columbia's future licensee(s), for the purpose of granting exclusive licensing rights (subject to pre-existing licenses) to said Company Patents in a timely fashion and under commercially reasonable terms. In the event that Columbia grants a license to a Third Party to intellectual property that includes Company Technical Information or Company Patents, the Parties will negotiate in good faith Company's share of any net revenue received by Columbia from such license taking into consideration Company's contribution to the intellectual property licensed to such Third Party. In the event that this Agreement is terminated by either Party under Section 17, Company will transfer the ownership of the Orphan Drug Designation and Orphan Medicinal Product Designation promptly after the effective date of termination of this Agreement to Columbia.

b. Unless terminated earlier under any provision of this Agreement, the term of the licenses granted hereunder shall extend, on a country-by-country and product-by-product basis, until the later of (i) the date of expiration of the last to expire of the issued patents falling within the definition of Patents, (ii) [\*\*\*] after the first bona fide commercial sale of a Product in the country in question, or (iii) expiration of any market exclusivity period granted by a regulatory agency.

c. The licenses granted under this Agreement may be terminated by Columbia or, at Columbia's option, Columbia has the right to convert any or all of such exclusive licenses granted under this Agreement to nonexclusive licenses, with no right to sublicense, and no right by company to initiate legal proceedings pursuant to Section 11: (i) upon written notice to Company if Columbia elects to terminate in accordance with Section 6b; (ii) upon written notice to Company for Company's material breach of the Agreement and Company's failure to cure such material breach in accordance with Section 15b; (iii) in the event Company becomes insolvent or is generally not paying its debts as such debts become due; (iv) in the event Company ceases to conduct business as a going concern; and (v) in the event Company (or any entity or person acting on its behalf) initiates any proceeding challenging the validity or enforceability of any Patent in any court, administrative agency or other forum. Termination under (ii) – (v) shall be effective upon date of notice sent pursuant to Section 17.

d. Upon any termination of this Agreement pursuant to Section 16c, all sublicenses granted by the Company under it shall be assigned to Columbia, upon request and at Columbia's discretion, provided that Columbia's obligations under such sublicense shall be consistent with and not exceed Columbia's obligations to Company under this Agreement and provided that such sublicense agrees in a writing sent to Columbia to assume all obligations of this Agreement for the benefit of Columbia, including the obligations to make all payments due under this Agreement, including but not limited to those specified in Section 4b, 4c, 4d, 4h and 11b.

e. Sections 4c(ii), 4h, 5c, 5f, 5g, 5h, 7, 8, 9, 10, 12, 16a, 16d, 16e, 16f, 16g, 16h, 17, 19, 22, 23, and 25 will survive any termination or expiration of this Agreement.

f. Any termination of this Agreement shall not adversely affect any rights or obligations that may have accrued to either party prior to the date of termination, including without limitation, Company's obligation to pay all amounts due and payable under Sections 4 (including the minimum royalties accrued under subsection b(ii)(B) thereof and any payments required under subsection h thereof), 5 and 11 hereof.

g. Upon any termination of this Agreement for any reason other than the expiration of this Agreement under Section 16b or Company's failure to cure a material breach of this Agreement under Section 16c(ii), Company, Sublicensees, Designees, and their Affiliates shall have the right, for one year or such longer period as the parties may reasonably agree, to dispose of Products or substantially completed Products then on hand, and to complete orders for Products then on hand, and royalties shall be paid to Columbia with respect to such Products as though this Agreement had not terminated. If this Agreement expires under Section 16b, then the Company shall thereafter be free to use the Technical Information and Materials without any further obligation to Columbia.

h. Notwithstanding anything to the contrary in the Agreement, to the extent the manufacture of a Product is Covered By an issued patent within the definition of Patents and occurs prior to the expiration of such issued patent, the sale of that Product after the expiration date of the issued patent shall still constitute a royalty-bearing sale under Section 4.

17. Notices. Any notice required or permitted to be given under this Agreement shall be sufficient if in writing and shall be considered given (i) when mailed by certified mail (return receipt requested), postage prepaid, or (ii) on the date of actual delivery by hand or overnight delivery, with receipt acknowledged,

if to Columbia, to: Executive Director  
Columbia Technology Ventures  
Columbia University  
80 Claremont Avenue, #4F, Mail Code 9606  
New York, NY 10027-5712

copy to: General Counsel  
Columbia University  
412 Low Memorial Library  
535 West 116<sup>th</sup> Street, Mail Code 4308  
New York, New York 10027

if to the Company, to: Chairman & CEO  
Tom Lin, MD, PhD  
Lin Bioscience, Inc.  
12F., No. 68, Sec 5, Zhongxiao E. Road, Xinyi Dist.,  
Taipei City 110, Taiwan (R.O.C.)

copy to: Irene Wang  
12358 Carmel Country Road, A304  
San Diego, CA 92130, USA

or to such other address as a party may specify by notice hereunder.

18. Assignment. This Agreement and all rights and obligations hereunder may not be assigned by either party without the written consent of the other party except in connection with the sale of all or substantially all of the assets of such party or the division to which this agreement relates. Any attempt to assign without compliance with this provision shall be void.

19. Waiver and Election of Remedies. The failure of any party to insist upon strict adherence to any term of this Agreement on any occasion shall not be considered a waiver or deprive that party thereafter of the right to insist upon strict adherence to that term or any other term of this Agreement. All waivers must be in writing and signed by an authorized representative of the party against which such waiver is being sought. The pursuit by either party of any remedy to which it is entitled at any time or continuation of the Agreement despite a breach by the other shall not be deemed an election of remedies or waiver of the right to pursue any other remedies to which it may be entitled.

20. Binding on Successors. This Agreement shall be binding upon and inure to the benefit of the parties and their respective successors and assigns to the extent assignment is permitted under this Agreement.

21. Independent Contractors. It is the express intention of the parties that the relationship of Columbia and the Company shall be that of independent contractors and shall not be that of agents, partners or joint venturers. Nothing in this Agreement is intended or shall be construed to permit or authorize either party to incur, or represent that it has the power to incur, any obligation or liability on behalf of the other party.

22. Entire Agreement; Amendment. This Agreement, together with the Exhibits, sets forth the entire agreement between the parties concerning the subject matter hereof and supersedes all previous agreements, written or oral, concerning such subject matter. This Agreement may be amended only by written agreement duly executed by the parties.

23. Severability. In the event that any provision of this Agreement is held by a court of competent jurisdiction to be unenforceable because it is invalid, illegal or unenforceable, the validity of the remaining provisions shall not be affected, and the rights and obligations of the parties shall be construed and enforced as if the Agreement did not contain the particular provisions held to be unenforceable, unless such construction would materially alter the meaning of this Agreement. By way of example, but not by way of limitation, Sections 4h(i), 4h(ii) and 4h(iii) are intended by Company and Columbia to be severable from each other, such that if one clause is found to be unenforceable, the other clauses remain operative and in effect.

24. No Third-Party Beneficiaries. Except as expressly set forth herein, the parties hereto agree that there are no third-party beneficiaries of any kind to this Agreement.

25. Governing Law. This Agreement shall be governed by and construed in accordance with the internal substantive laws of the State of New York as applicable to agreements made and wholly performed within the State of New York, and without reference to the conflict or choice of laws principles of any jurisdiction. Unless otherwise separately agreed in writing, the parties agree that any and all claims arising under or related to this Agreement shall be heard and determined only in either the United States District Court for the Southern District of New York or in the courts of the State of New York located in the City and County of New York, and the parties irrevocably agree to submit themselves to the exclusive and personal jurisdiction of those courts and irrevocably waive any and all rights any such party may now or hereafter have to object to such jurisdiction or the convenience of the forum.

26. Execution in Counterparts; Facsimile or Electronic Transmission. This Agreement may be executed in counterparts, and by facsimile or electronic transmission. This Agreement is not binding on the parties until it has been signed below on behalf of each party.

IN WITNESS WHEREOF, Columbia and the Company have caused this Agreement to be executed by their duly authorized representatives as of the day and year first written above.

**THE TRUSTEES OF COLUMBIA  
UNIVERSITY IN THE CITY OF NEW YORK**

By /s/  
Executive Director,  
Columbia Technology Ventures

TTS#49055

**Lin Bioscience, Inc.**

By /s/ Tom Lin

Title Chairman and Chief Executive Officer

EXHIBIT A

Patents

[\*\*\*]



Exhibit B

Materials

[\*\*]

Exhibit C  
Technical Information

[\*\*\*]



August 15, 2017

Tom Lin, MD, PhD  
Lin Bioscience  
12F., No. 68, Sec 5, Zhongxiao E. Road, Xinyi Dist.,  
Taipei City 110, Taiwan (R.O.C.)

RE: Amendment to the Exclusive License Agreement between Lin Bioscience, Inc. (“Company”) and The Trustees of Columbia University in the City of New York (“Columbia”), dated September 13, 2016, (“Agreement”)

Dear Dr. Lin:

The above referenced Exclusive License Agreement (“Agreement”) entered into by the Trustees of Columbia University in the City of New York (“Columbia”) and Lin Bioscience, Inc. (“Company”), dated as of September 13, 2016, is hereby amended, pursuant to Section 22 of the Agreement, as follows:

- 1. l.e. Field: The parties agree to delete and replace Section 1e. with the following:

““Field” shall mean all uses.”

All other terms and conditions of the Agreement shall remain in full force and effect, except as expressly amended herein. If there is any inconsistency or conflict between this Letter and the Agreement, the provisions of this Letter shall govern and control. This Letter shall be binding upon, and shall inure to the benefit of, the parties hereto and their respective successors and assigns.

Please indicate your agreement to the terms of this Letter by signing where indicated below, and returning a copy to my attention for countersignature.

Very truly yours,

/s/ Scot Hamilton  
Scot Hamilton  
Senior Director

09-07-2017

TTS# 50909

AGREED AND ACKNOWLEDGED:

Lin Bioscience, Inc.  
By: /s/ Tom Lin  
Tom Lin  
Chairman and CEO  
Date: 15 AUGUST 2017

**MORNINGSIDE** 80 Claremont Avenue, 4th Floor, MC 9606, New York, New York 10027 T 212.854.8444 F 212.854.8463  
**MEDICAL CENTER** 630 West 168th Street, PH 1535, New York, New York 10032 T 212.305.5198 F 212.305.5070  
techventures@columbia.edu www.techventures.columbia.edu

Via Federal Express and electronic mail

May 3, 2018

Chairman & CEO  
Tom Lin, MD, PhD  
Lin Bioscience, Inc.  
12F., No. 68, Sec 5, Zhongxiao E. Road, Xinyi Dist.,  
Taipei City 110, Taiwan (R.O.C.)

**Re: Exclusive License Agreement between The Trustees of Columbia University in the City of New York ("Columbia") and Lin Bioscience, Inc. ("LBS"), dated September 13, 2016 ("License Agreement")**

Dear Dr. Lin,

It is our understanding that LBS is in the process of restructuring and is requesting Columbia's approval for the following assignments of the License Agreement: (i) the assignment by LBS of all of its rights, title, interest, and obligations in and to the License Agreement to its wholly owned Cayman subsidiary Lin BioScience International Ltd ("LBS KY1") (the "First Assignment"), and (ii) the assignment by LBS KY1 of all of its rights, title, interest, and obligations in and to the License Agreement to its wholly owned Cayman subsidiary Lin BioScience Co., Ltd. ("LBS KY2") (the "Second Assignment"). The restructuring and the First Assignment and Second Assignment are illustrated and summarized in Exhibit A hereto, which you have kindly provided to us.

You have advised us that in the First Assignment, LBS KY1 will assume and perform all of LBS's duties, obligations and responsibilities under the License Agreement and that in the Second Assignment, LBS KY2 will assume and perform all of LBS KY1's duties, obligations and responsibilities under the License Agreement.

Columbia hereby consents to the First Assignment and the Second Assignment as described herein. Upon the date that the two subscription agreements for this restructuring are executed, LBS KY2 shall be substituted for LBS in all respects under the License Agreement and LBS KY2 (i) shall assume all duties, obligations and responsibilities under the License Agreement and (ii) shall be entitled to enforce any and all rights and benefits arising under the License Agreement.

---

Sincerely,

/s/ Scot Hamilton

---

Scot Hamilton, Director  
Columbia Technology Ventures,  
Pursuant to the Delegation of Authority  
to Sign Documents on behalf of  
Columbia University Letter, Dated July 1,  
2017, after complying with all requirements therein for exercise of such authority.

Cc: Irene Wang

---

Current Structure

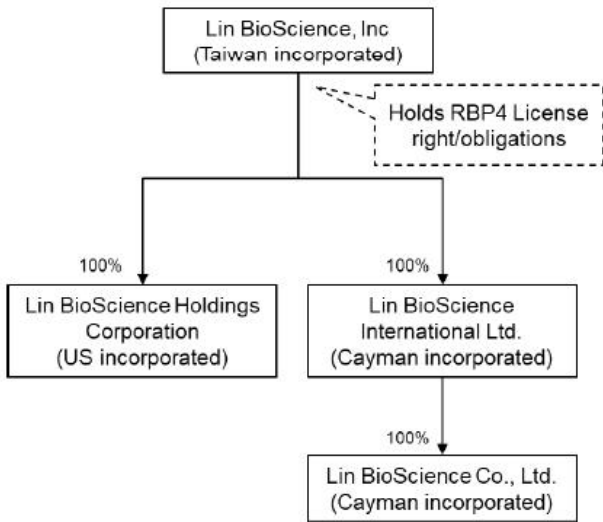

=

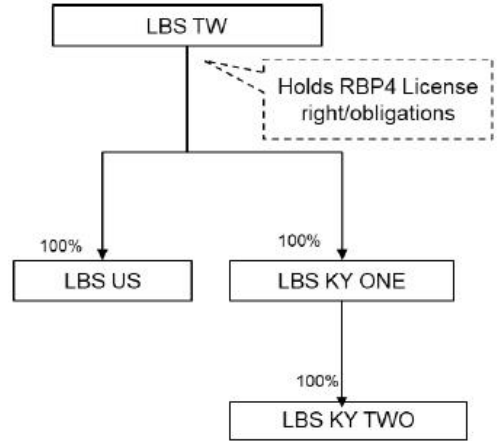

LBS restructuring & assignment

Step 1

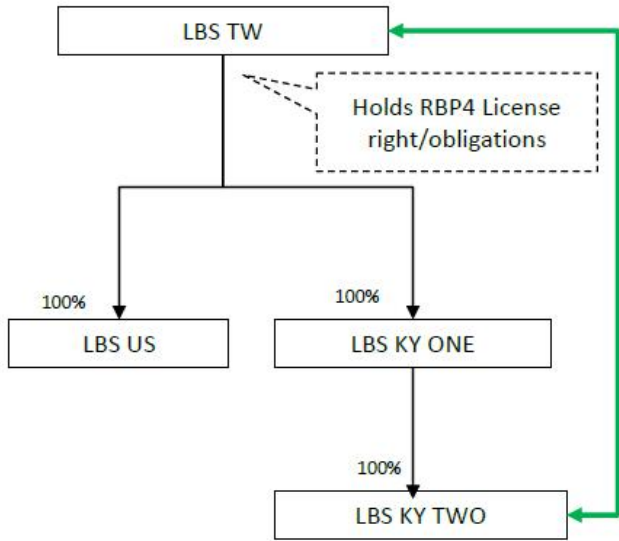

1. LBS TW signs agreement with LBS KY ONE on day "T", to (1) assign all LBS TW's rights and obligations under Columbia RBP4 License agreement to LBS KY ONE with a consideration of USD[xx]mn paid by issuing LBS KY ONE's shares, and (2) to sell LBS US to LBS KY ONE, with a consideration of USD[xx]mn paid by issuing LBS KY ONE's shares. ("LBS TW-KY ONE" agreement)

LBS restructuring & assignment

Step 2

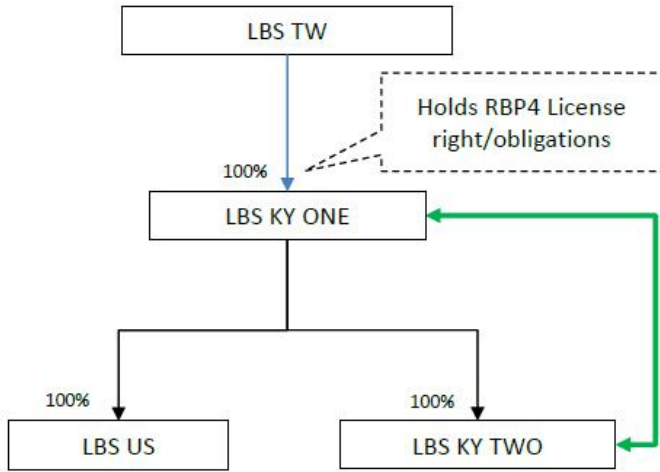

2. LBS TW signs agreement with LBS KY ONE on day "T", to (1) assign all LBS TW's rights and obligations under Columbia RBP4 License agreement to LBS KY ONE with a consideration of USD[xx]mn paid by issuing LBS KY ONE's shares, and (2) to sell LBS US to LBS KY ONE, with a consideration of USD[xx]mn paid by issuing LBS KY ONE's shares. ("LBS TW-KY ONE" agreement)



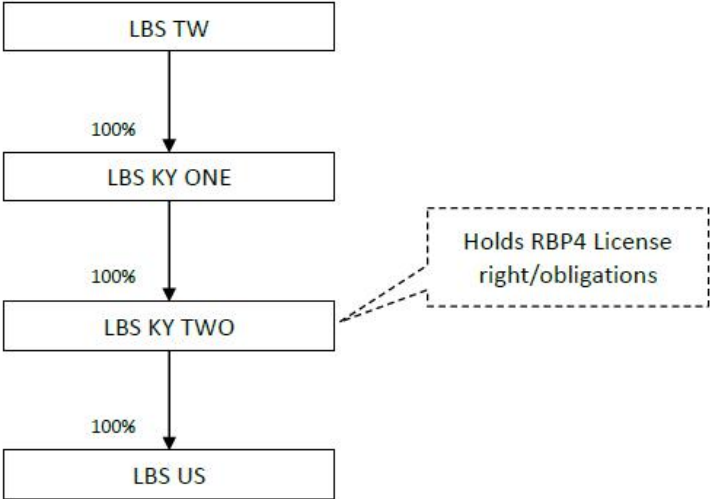

**CERTAIN CONFIDENTIAL INFORMATION CONTAINED IN THIS DOCUMENT, MARKED BY [\*\*\*], HAS BEEN OMITTED BECAUSE IT IS NOT MATERIAL AND WOULD LIKELY CAUSE COMPETITIVE HARM TO THE COMPANY IF PUBLICLY DISCLOSED**

**SECOND AMENDMENT TO EXCLUSIVE LICENSE AGREEMENT**

This SECOND AMENDMENT TO EXCLUSIVE LICENSE AGREEMENT (the "Second Amendment") is made and entered into by and between THE TRUSTEES OF COLUMBIA UNIVERSITY IN THE CITY OF NEW YORK ("Columbia") and BELITE BIO, INC ("Company"). This Second Amendment shall become effective upon the date that this Second Amendment is signed by both Columbia and Company (the "Second Amendment Effective Date").

**WITNESSETH:**

---

**WHEREAS**, Columbia and LIN BIOSCIENCE, INC. are parties to that certain Exclusive License Agreement dated September 13, 2016, and amended August 15, 2017 (the "License Agreement");

**WHEREAS**, LIN BIOSCIENCE, INC. and LIN BIOSCIENCE INTERNATIONAL LTD. entered an agreement dated June 30, 2018 to assign the License Agreement to LIN BIOSCIENCE INTERNATIONAL LTD. (the "First Assignment");

**WHEREAS**, LIN BIOSCIENCE INTERNATIONAL LTD. and Company (formerly known as Lin BioScience Co., Ltd.) entered an agreement dated July 1, 2018 to assign the License Agreement to Company (the "Second Assignment");

**WHEREAS**, Columbia provided its consent to the First Assignment and the Second Assignment dated May 3, 2018; and

**WHEREAS**, Company and the Columbia wish to amend the License Agreement in certain respects to add intellectual property licensed to Company under the License Agreement;

**NOW, THEREFORE**, in consideration of the premises and the mutual covenants herein set forth, the parties hereto hereby agree as follows:

1. Except as modified through this Second Amendment, all provisions of the License Agreement shall remain in full force and effect. Each capitalized term used herein, and not otherwise defined herein, shall have the meaning set forth in the License Agreement.

---

2. Exhibit A of the License Agreement is hereby amended by adding the following Patent:

Invention Report No.	Application	Filing Date	Country
[***]	[***]		
	[***]	[***]	[***]

3. Except as expressly set forth in this Second Amendment, the License Agreement shall remain in full force and effect. If there is any inconsistency or conflict between this Second Amendment and the License Agreement, the provisions of this Second Amendment shall govern and control. This Second Amendment may be executed in any number of counterparts, each of which shall be deemed an original, but all of which together shall constitute one and the same instrument. This Second Amendment shall be binding upon, and shall inure to the benefit of, the parties hereto and their respective successors and assigns.
-

IN WITNESS WHEREOF, the parties hereto have caused this Second Amendment to the License Agreement to be executed as of the date first above written.

**THE TRUSTEES OF COLUMBIA  
UNIVERSITY IN THE CITY OF NEW YORK**

By /s/ Scot G. Hamilton

Name: Scot G. Hamilton

Title: AVP

TTS: 53601 (Original: 49055)

Date: March 27, 2019

**BELITE BIO, INC**

By /s/ Tom Lin

Name: Tom Lin

Title: Director

Date: March 28, 2019

---

**CERTAIN CONFIDENTIAL INFORMATION CONTAINED IN THIS DOCUMENT, MARKED BY [\*\*\*], HAS BEEN OMITTED BECAUSE IT IS NOT MATERIAL AND WOULD LIKELY CAUSE COMPETITIVE HARM TO THE COMPANY IF PUBLICLY DISCLOSED**

**THIRD AMENDMENT  
TO  
EXCLUSIVE LICENSE AGREEMENT**

This THIRD AMENDMENT TO EXCLUSIVE LICENSE AGREEMENT (this "Amendment") is made and entered into as of October 24, 2019 ("Third Amendment Effective Date") by and between Belite Bio, Inc ("Company") and The Trustees of Columbia University in the City of New York ("Columbia").

**WITNESSETH:**

---

WHEREAS, Columbia and LIN BIOSCIENCE, INC. are parties to that certain Exclusive License Agreement dated September 13, 2016, and amended on August 15, 2017 (the "License Agreement");

WHEREAS, LIN BIOSCIENCE, INC. and LIN BIOSCIENCE INTERNATIONAL LTD. entered an agreement dated June 30, 2018 to assign the License Agreement to LIN BIOSCIENCE INTERNATIONAL LTD. (the "First Assignment");

WHEREAS, LIN BIOSCIENCE INTERNATIONAL LTD. and Company (formerly known as Lin BioScience Co., Ltd.) entered an agreement dated July 1, 2018 to assign the License Agreement to Company (the "Second Assignment");

WHEREAS, Columbia provided its consent to the First Assignment and the Second Assignment dated May 3, 2018;

WHEREAS, Company and Columbia are parties to the License Agreement, and amended on March 28, 2019 (collectively, the "Agreement"). Each capitalized term used herein, and not otherwise defined herein, shall have the meaning set forth in the Agreement; and

WHEREAS, Company and the Columbia wish to amend the Agreement in certain respects;

NOW, THEREFORE, in consideration of the premises and the mutual covenants herein set forth, the parties hereto hereby agree as follows:

---

1. The first two lines of Section 2b of the Agreement is deleted in its entirety and replaced with the following:

“Columbia grants to Company the right to grant sublicenses, provided that (i) the Sublicensee agrees to”

2. Section 4c(ii) of the Agreement shall be deleted in its entirety and replaced with the following:

“Company or Sublicensee, as applicable, will pay to Columbia an amount equal to [\*\*\*] of Priority Review Voucher Revenue. If Company or Sublicensee, as applicable, have not sold the Priority Review Voucher [\*\*\*] receipt of the Priority Review Voucher, royalties due under Section 3b(ii)(A)(1) shall [\*\*\*] of Net Sales of Patent Products.”

3. Section 4d shall be amended by adding the following language at the end of the provision:

“In the event that Company achieves a milestone for a Product without the need to achieve any milestone(s) preceding it, Company will pay Columbia the milestone payment for the achieved milestone and payment(s) due for any preceding milestone(s) not already paid for such Product.”

4. Except as expressly set forth in this Third Amendment, the Agreement shall remain in full force and effect. If there is any inconsistency or conflict between this Third Amendment and the Agreement, the provisions of this Amendment shall govern and control. This Third Amendment may be executed in any number of counterparts, each of which shall be deemed an original, but all of which together shall constitute one and the same instrument. This Third Amendment shall be binding upon, and shall inure to the benefit of, the parties hereto and their respective successors and assigns.

IN WITNESS WHEREOF, the parties hereto have caused this Third Amendment to the License Agreement to be executed as of the date first above written.

**THE TRUSTEES OF COLUMBIA  
UNIVERSITY IN THE CITY OF NEW YORK**

By /s/ Scot G. Hamilton

Name: Scot G. Hamilton

Title: AVP

TTs#55016

**BELITE BIO, INC**

By /s/ Tom Lin

Name: Tom Lin

Title: Director

---

**CERTAIN CONFIDENTIAL INFORMATION CONTAINED IN THIS DOCUMENT, MARKED BY [\*\*\*], HAS BEEN OMITTED BECAUSE IT IS NOT MATERIAL AND WOULD LIKELY CAUSE COMPETITIVE HARM TO THE COMPANY IF PUBLICLY DISCLOSED**

**FOURTH AMENDMENT  
TO  
EXCLUSIVE LICENSE AGREEMENT**

This FOURTH AMENDMENT TO EXCLUSIVE LICENSE AGREEMENT (this "Amendment") is made and entered into as of September 1, 2021 ("Fourth Amendment Effective Date") by and between Belite Bio, Inc ("Company") and The Trustees of Columbia University in the City of New York ("Columbia").

**WITNESSETH:**

---

WHEREAS, Columbia and LIN BIOSCIENCE, INC. are parties to that certain Exclusive License Agreement dated September 13, 2016, and amended on August 15, 2017, March 28, 2019 and October 24, 2019 (collectively, the "License Agreement");

WHEREAS, LIN BIOSCIENCE, INC. and LIN BIOSCIENCE INTERNATIONAL LTD. entered an agreement dated June 30, 2018 to assign the License Agreement to LIN BIOSCIENCE INTERNATIONAL LTD. (the "First Assignment");

WHEREAS, LIN BIOSCIENCE INTERNATIONAL LTD. and Company (formerly known as Lin BioScience Co., Ltd.) entered an agreement dated July 1, 2018 to assign the License Agreement to Company (the "Second Assignment");

WHEREAS, Columbia provided its consent to the First Assignment and the Second Assignment dated May 3, 2018;

WHEREAS, Company and Columbia are parties to the License Agreement as amended (collectively, the "Agreement"). Each capitalized term used herein, and not otherwise defined herein, shall have the meaning set forth in the Agreement; and

WHEREAS, Company and Columbia wish to amend the Agreement in certain respects;

NOW, THEREFORE, in consideration of the premises and the mutual covenants herein set forth, the parties hereto hereby agree as follows:

1. Section 6 of the Agreement (Diligence) is deleted in its entirety and replaced with the following:

6. Diligence.

a. Company shall use its commercially reasonable efforts to research, discover, develop and market a Products for commercial sale and distribution in the Field and throughout the Territory, and to such end, such efforts will include the following:

- (i) Investigational New Drug Application (IND)
  - File IND [\*\*\*] of receiving final study report on GLP toxicity studies (Company as Sponsor)
- (ii) Phase I Clinical Trials
  - MAD Phase I trial (normal volunteers) completed [\*\*\*]
  - Complete Phase Ib trial in Stargardt Disease patients [\*\*\*] (may be combined with Phase II for Stargardt Disease)
- (iii) Phase II/III Clinical Trials
  - Start Phase II in Stargardt Disease [\*\*\*]
  - Start Phase III in Stargardt Disease [\*\*\*]
  - Start Phase II or Phase III clinical trial in Dry AMD [\*\*\*]
- (iv) Regulatory Approval
  - Obtain Regulatory Approval in Stargardt Disease [\*\*\*]
  - Obtain Regulatory Approval in Dry AMD [\*\*\*]

2. Company and Columbia acknowledge that Columbia's employee Dr. Kostantin Petrukhin and Company's employee(s) Yu-Hsin Tom Lin and Cheng-Chi Irene Wang are inventors on certain patent applications filed by Company, and that such Patents are jointly-owned by Company and Columbia (the "Joint Patent(s)"). Company and Columbia agree that Company will continue to prepare, file and maintain such patent applications and/or patents for the Joint Patents at Company's sole expense, in consultation with Columbia using counsel reasonably acceptable to Columbia. The following shall be inserted at the end of Section 11(a) (Patent Prosecution and Maintenance; Litigation):



“For any Patents jointly-owned by Columbia and Company (“Joint Patent(s)”) filed by or on behalf of Company, Company shall instruct its patent counsel (1) to copy Columbia on all correspondence related to such Patents (including but not limited to copies of each patent application, office action, response to office action, request for terminal disclaimer, and request for reissue or reexamination of any patent or patent application) and (2) as requested by Columbia, to provide an update as to the current status of such Patents.

Company shall not abandon any Joint Patents without giving Columbia sixty (60) days’ written notice. Upon receiving such notice, Columbia shall have the right in its sole discretion to remove such Joint Patents from the Patents exclusively licensed to the Company under this Agreement and to assume complete control of all further patent prosecution in that country at Columbia’s sole expense, and Company will have, to the fullest extent permitted by applicable law and contract, no further right, title, or interest in that particular patent application or any patent issuing in the applicable country(ies), and will not be entitled to commercialize said Joint Patent(s). Company shall at the request of Columbia freely execute any documents necessary to vest the maximum legally-permissible ownership or control of the applicable patent application(s) or patent(s) in Columbia (e.g., by assignment or exclusive license).”

3. The parties wish to add the Joint Patents to the exclusive license to Patents granted by Columbia to Company under the Agreement. The following Patents shall be added to Exhibit A:

Invention Report No.	Application / Patent No.	Filing Date	Country
***	***		
	***	***	***
	***	***	***
	***	***	***
	***	***	***
	***	***	***
	***	***	***

4. Except as expressly set forth in this Fourth Amendment, the Agreement shall remain in full force and effect. If there is any inconsistency or conflict between this Fourth Amendment and the Agreement, the provisions of this Amendment shall govern and control. This Fourth Amendment may be executed in any number of counterparts, each of which shall be deemed an original, but all of which together shall constitute one and the same instrument. This Fourth Amendment shall be binding upon, and shall inure to the benefit of, the parties hereto and their respective successors and assigns.

IN WITNESS WHEREOF, the parties hereto have caused this Fourth Amendment to the License Agreement to be executed as of the date first above written.

**THE TRUSTEES OF COLUMBIA  
UNIVERSITY IN THE CITY OF NEW YORK**

By: /s/ Scot G. Hamilton  
Name: Scot G. Hamilton  
Title: AVP for CTV at Columbia University

TTS #58759 (Original Agt #49055)

**BELITE BIO, INC**

By: /s/ Tom Lin  
Name: Tom Lin  
Title: Director

**LBS-008 RESEARCH AND DEVELOPMENT SERVICES AGREEMENT**

This Research and Development Services Agreement (this “**Agreement**”), effective as of July 1, 2021 (“**Effective Date**”), is entered into by and between Belite Bio, Inc., a Cayman corporation, with contact office located at 12F., No.68, Sec. 5, Zhongxiao E. Rd., Xinyi Dist., Taipei City 110, Taiwan (“**Belite Inc**”) and Lin BioScience, Inc., a Taiwan corporation, located at 12F., No.68, Sec. 5, Zhongxiao E. Rd., Xinyi Dist., Taipei City 110, Taiwan (“**Lin Inc.**”).

**BACKGROUND**

- A. Lin Inc. is a drug development company specializing in innovative therapies for diseases with unmet medical needs. Its pipeline aimed at treating life-threatening or disabling diseases in oncology, ophthalmology and metabolic disease.
- B. Belite Inc is the subsidiary of Lin Inc.
- C. Belite Inc desires to have Lin Inc. perform certain new drug development services based on the terms and conditions set forth below.

NOW, **THEREFORE**, in consideration of the mutual promises and covenants contained herein, the parties hereto agree as follows:

**1. DEFINITIONS**

- (a) “**Deliverables**” shall mean the results to be delivered by Lin Inc. to Belite Inc as set forth in the SOW.
- (b) “**IPR**” means patents, copyrights, trade secrets, design rights or any other proprietary rights, applications for any of the foregoing and any other protection of a similar nature throughout the world, whether now existing or hereinafter developed or obtained.
- (c) “**SOW**” means the document titled “**Statement of Work**” that is attached hereto as Exhibit A.
- (d) “**Services**” means the services provided by Lin Inc. relating to, including without limitation, conduct or facilitation of research, development or clinical trials for pipeline LBS-008 as set forth in the SOW.

**2. SERVICES**

Services. Subject to the terms and conditions of this Agreement, including without limitation the SOW, during the term of this Agreement, Lin Inc. shall provide the Services and deliver the Deliverables to Belite Inc as set forth in the SOW. Subject to the requirements set forth in the SOW, Belite Inc shall have sole discretion and control over the work performed under this Agreement and the manner in which such work is performed and Lin Inc. shall follow Belite Inc’s instruction.

### 3. FEES AND BILLING

- (a) Fees. Belite Inc shall pay Lin Inc. for the Services for an amount equal to 110 percent of Lin Inc.'s actual costs for its performance of the Services, including its costs of research and development and personnel, provided that Lin Inc. shall provide Belite Inc with relevant invoices and documentation proving such costs are reasonably incurred by Lin Inc. for its performance of the Services.
- (b) Expenses. Belite Inc will reimburse Lin Inc. for Lin Inc.'s actual expenses for transportation, travel and lodging provided that such expenses are incurred by Lin Inc. for its performance of the Services and will be reimbursed against invoices.
- (c) Billing and Payment Terms. The fees and expenses set forth in Subparagraphs (a) and (b) of this Section 3 are the only payments Belite Inc shall pay to Lin Inc. under this Agreement.
- (d) Taxes. All payments required by this Agreement are exclusive of any and all sales, value-added, use, or withholding tax on international services. Such taxes, fees and/or duties, except any taxes based on Lin Inc.'s income, will be assumed by Belite Inc without deduction to amounts owed to Lin Inc.

### 4. DELIVERABLES AND IPR

- (a) Deliverables. Lin Inc. will transfer to Belite Inc the ownership of the Deliverables.
- (b) IPR. Lin Inc. acknowledges and agrees that Belite Inc is the sole and exclusive owner of all IPR that Lin Inc. directly or indirectly managed, developed or assisted in the performance of the Services.

### 5. CONFIDENTIAL INFORMATION

- (a) Confidential Information. "**Confidential Information**" means information, including without limitation information concerning or relating to a party's business, plans, customers, technology, products, and the terms and conditions of this Agreement, in any form that may be disclosed by a party hereto (the "**Disclosing Party**") to the other party (the "**Receiving Party**"); provided that it shall be either (a) conspicuously marked "**Confidential**" or "**Proprietary**" if disclosed to the Receiving Party in tangible form, or (b) if disclosed orally, is reduced by the Disclosing Party to a writing conspicuously marked "**Confidential**" or "**Proprietary**", given to the Receiving Party within thirty (30) days of such oral disclosure.
- (b) Exclusions. Notwithstanding the provisions of Subparagraph (a) of this Section 5, Confidential Information excludes information that the Receiving Party can demonstrate: (i) is or becomes part of the public domain through no fault or breach of the Receiving Party; (ii) is known to the Receiving Party prior to disclosure thereof; (iii) is subsequently rightfully obtained by the Receiving Party from a third party that has the legal right to disclose such information to the Receiving Party; (iv) is independently developed by the Receiving Party; (v) is disclosed to others without an obligation of confidentiality; and (vi) is required by law to be disclosed by the Receiving Party, provided that the Receiving Party gives the Disclosing Party prompt written notice of such requirement prior to such disclosure.

- (c) Use and Disclosure. During the term of this Agreement and for a period of 3 years thereafter, each party agrees that it shall use the Confidential Information of the other party only to the extent reasonably necessary to perform its obligations or exercise its rights under this Agreement and will not disclose, or permit to be disclosed, the same, directly or indirectly, to any third party except as permitted under this Agreement or otherwise approved in writing by the other party. Each party agrees to exercise at least reasonable care in protecting the Confidential Information from unauthorized use and disclosure.

## **6. LIMITATION OF LIABILITY**

IN NO EVENT WILL EITHER PARTY BE LIABLE FOR ANY LOSS OF PROFITS, LOSS OF USE, BUSINESS INTERRUPTION, LOSS OF DATA, DELAY, COST OF COVER, OR ANY INDIRECT, SPECIAL, OR CONSEQUENTIAL DAMAGES OF ANY KIND IN CONNECTION WITH, RELATING TO OR ARISING OUT OF THIS AGREEMENT, THE SERVICES OR THE DELIVERABLES, EVEN IF SUCH PARTY HAS BEEN ADVISED OF THE POSSIBILITY OF SUCH DAMAGES.

## **7. REPRESENTATION & WARRANTIES**

Lin Inc. represents and warrants that the Services, Deliverables, and any other information/materials provided by Belite Bio, LLC to Belite Inc under this Agreement do not and will not infringe or misappropriate any IPR of any third party or constitute unfair competition or trade practices under the laws of any jurisdiction and there are no claims pending against Lin Inc.

## **8. INDEMNIFICATION**

Lin Inc. shall defend, indemnify and hold Belite Inc harmless from any and all claims, damages, losses or suits arising out of or in connection with the performance of this Agreement.

## **9. TERM AND TERMINATION**

- (a) Term. This Agreement shall become effective on the Effective Date, and will continue to be in effect until June 30, 2022 unless and until earlier terminated according to the provisions of Section 9(b).
- (b) Termination.
  - (i) Either party will have the right to terminate this Agreement, or the applicable SOW, if the other party breaches any material term or condition of this Agreement and fails to cure such breach within 30 days after receipt of written notice of such breach.

- (ii) Belite Inc shall have the right to terminate this Agreement, or the applicable SOW, for its convenience by providing Lin Inc. with 30-day advance written notice of such termination.
- (iii) Either party may terminate this Agreement if: (1) the other party becomes the subject of a voluntary petition in bankruptcy or any voluntary proceeding relating to insolvency, receivership, liquidation, or composition for the benefit of creditors; or (2) the other party becomes the subject of an involuntary petition in bankruptcy or any involuntary proceeding relating to insolvency, receivership, liquidation, or composition for the benefit of creditors, if such petition or proceeding is not dismissed within sixty (60) days of filing.
- (c) Effect of Termination. Upon termination or expiration of this Agreement: (i) Lin Inc. may immediately cease providing Services hereunder; and (ii) any and all payment obligations of Belite Inc under this Agreement will become due immediately. Within thirty (30) days after such expiration or termination, each party shall return all tangible embodiments of Confidential Information of the other party in its possession at the time of expiration or termination.
- (d) Survival. Sections 1, 4, 5, 6, 7, 8, 9, 10 and 11 will survive any expiration or termination of this Agreement.

#### **10. GOVERNING LAW & DISPUTE RESOLUTION**

- (a) Governing Law. The rights and obligations of the parties under this Agreement shall be governed by and construed under the laws of Taiwan (Republic of China, R.O.C., hereinafter Taiwan) without reference to conflict of laws principles.
- (b) Dispute Resolution. The parties agree that the Taiwan Taipei District Court shall have the exclusive jurisdiction over all questions and controversies arising out of or in connection with the performance or execution of this Agreement.

#### **11. MISCELLANEOUS PROVISIONS**

- (a) Conflict with Exhibits. In the event that there is any conflict or ambiguity between a provision in this Agreement and that in any of the exhibits hereto this Agreement shall control and have precedence over such exhibit.
- (b) Force Majeure. Neither party will be liable for any failure or delay in its performance under this Agreement due to any cause beyond its reasonable control, including without limitation act of war, acts of God, earthquake, flood, embargo, riot, sabotage, labor shortage or dispute, governmental act or failure of the internet.
- (c) Assignment. Neither party may assign this Agreement without the prior written consent of the other party, except that either party may assign this Agreement in whole as part of a corporate reorganization, consolidation, merger, or sale of substantially all of its assets without any prior consent of the other party. Any attempted assignment or delegation without such consent will be void. This Agreement will bind and inure to the benefit of each party's successors and permitted assigns.

- (d) Notices. Any notice or communication required or permitted to be given hereunder may be delivered by hand, deposited with an overnight courier, sent by confirmed facsimile, or mailed by registered or certified mail, return receipt requested, postage prepaid, to the parties' respective address first set forth above, or at such other address as may hereafter be furnished in writing by either party hereto to the other. Such notice will be deemed to have been given as of the date it is delivered, mailed or sent, whichever is earlier.
- (e) Headings. The section headings and captions contained in this Agreement or its exhibits are included merely for convenience of reference. Such headings and captions are not to be considered part of, or to be used in interpreting, this Agreement and in no way limit or affect any of the contents of this Agreement or its exhibits.
- (f) Entire Agreement; Counterparts. This Agreement, including the SOW which is incorporated herein by reference, constitutes the complete and exclusive agreement between the parties with respect to the subject matter hereof, and supersedes and replaces any and all prior or contemporaneous discussions, negotiations, understandings and agreements, written and oral, regarding such subject matter. This Agreement may not be modified or amended except in a writing signed by a duly authorized representative of both parties. This Agreement may be executed in two or more counterparts, each of which will be deemed an original, but all of which together shall constitute one and the same instrument.

IN WITNESS WHEREOF, Belite Inc's and Lin Inc.'s authorized representatives have duly executed this Agreement below to indicate their assent to its terms:

**Belite Bio, Inc**

Signature: /s/ Tom Lin  
Print Name: Tom Lin  
Title: Director

**Lin BioScience, Inc.**

Signature: /s/ Tom Lin  
Print Name: Tom Lin  
Title: Chairman



**EXHIBIT A**  
**Statement of Work**

For the research and development of new drug LBS-008, services from Lin Inc. shall be as follows:

**LBS-008**

<b>Work</b>	
Clinical	Clinical study management

CERTAIN CONFIDENTIAL INFORMATION CONTAINED IN THIS DOCUMENT, MARKED BY [\*\*\*], HAS BEEN OMITTED BECAUSE IT IS NOT MATERIAL AND WOULD LIKELY CAUSE COMPETITIVE HARM TO THE COMPANY IF PUBLICLY DISCLOSED

FIFTH AMENDMENT

TO

EXCLUSIVE LICENSE AGREEMENT

This FIFTH AMENDMENT TO EXCLUSIVE LICENSE AGREEMENT (this "Amendment") is made and entered into as of February 4, 2022 ("Fifth Amendment Effective Date") by and between Belite Bio, Inc ("Company") and The Trustees of Columbia University in the City of New York ("Columbia").

WITNESSETH:

---

WHEREAS, Columbia and LIN BIOSCIENCE, INC. are parties to that certain Exclusive License Agreement dated September 13, 2016, and amended on August 15, 2017, March 28, 2019, October 24, 2019 and September 1, 2021 (collectively, the "License Agreement");

WHEREAS, LIN BIOSCIENCE, INC. and LIN BIOSCIENCE INTERNATIONAL LTD. entered an agreement dated June 30, 2018 to assign the License Agreement to LIN BIOSCIENCE INTERNATIONAL LTD. (the "First Assignment");

WHEREAS, LIN BIOSCIENCE INTERNATIONAL LTD. and Company (formerly known as Lin BioScience Co., Ltd.) entered an agreement dated July 1, 2018 to assign the License Agreement to Company (the "Second Assignment");

WHEREAS, Columbia provided its consent to the First Assignment and the Second Assignment dated May 3, 2018;

WHEREAS, Company and Columbia are parties to the License Agreement as amended (collectively, the "Agreement"). Each capitalized term used herein, and not otherwise defined herein, shall have the meaning set forth in the Agreement; and

WHEREAS, Company and Columbia wish to amend the Agreement in certain respects;

NOW, THEREFORE, in consideration of the premises and the mutual covenants herein set forth, the parties hereto hereby agree as follows:

1. The Parties agree that in the Fourth Amendment they intended to delete and replace only Section 6(a) and did not intend to delete Section 6(b). The following Section 6(b) is hereby restored to the Agreement with effect from September 13, 2016 as though it had never been deleted:
  - b. In the event that Company is unable to achieve a particular milestone set forth in Section 6a, Company will notify Columbia, and upon payment of a [\*\*\*] fee, Columbia will agree to a 6-month extension of the due date for such milestone. In the event after completion of Phase I Trials (as per Section 6a(ii)) there are unforeseen changes in clinical or regulatory development that Company believes would affect the timely achievement of any milestone, Company may request an extension from Columbia for such milestone, which will not be unreasonably withheld or delayed. Notwithstanding any other provisions of this Agreement, failure to achieve any of Company's diligence obligations under this Section shall result in Columbia having the option of terminating all of the licenses granted under Section 2 in accordance with Section 16 of this Agreement or converting any or all of such exclusive licenses to non-exclusive licenses with no right to sublicense and no right to initiate legal proceedings pursuant to Section 11.
    - i. No less often than every [\*\*\*] months after the Effective Date of this Agreement, Company shall report in writing to Columbia on progress made toward the diligence objectives set forth above.
2. The parties wish to include the compound [\*\*\*] in the scope of "Materials." Such compound shall be added to the table of Compounds in Exhibit B (Materials).
3. Section 16(a) shall be deleted and replaced with the following:
  - a. This Agreement shall be effective as of the Effective Date and shall continue in full force and effect until its expiration or termination in accordance with this Section 16.
    - (i) In addition, upon any termination of this Agreement pursuant to Section 16c, with respect to: (A) all know-how, technical information and data developed by Company ("Company Technical Information") during the term of this Agreement, and prior to its termination, to the extent such Company Technical Information is solely and directly related to the Company's efforts to develop Products, Columbia shall have the right to use such Company Technical Information for any purpose whatsoever on a non-exclusive basis, including the right to sublicense same to future licensees, and Company will provide Columbia (and/or its future licensees) access to any regulatory information filed or authorized by Company with any U.S. or foreign government agency with respect to such Products; and (B) all Company filed patent applications or Company obtained patents containing claims which, under a reasonable legal construction, could be interpreted to read on or cover a Product ("Company Patents"), Company hereby grants Columbia a royalty free, worldwide, non-exclusive license (together with rights to sublicense its future licensees) to make, use and sell Products under such Company Patents. The licenses granted in this Section 16(a)(i) are intended, in part, to reduce obstacles to commercialization of Columbia's Patents together with Company Patents in an effort to promote development and commercialization of federally funded inventions included within Columbia's Patents.

(ii) Company agrees upon request to enter into good faith negotiations with Columbia or Columbia's future licensee(s), for the purpose of granting exclusive licensing rights (subject to pre-existing licenses) to said Company Patents in a timely fashion and under commercially reasonable terms. In the event that Columbia grants a license to a Third Party to intellectual property that includes Company Technical Information or Company Patents, the Parties will negotiate in good faith Company's share of any net revenue received by Columbia from such license, taking into consideration Company's contribution to the intellectual property licensed to such Third Party. In the event that this Agreement is terminated by either Party under Section 16c, Company will transfer the ownership of the Orphan Drug Designation and Orphan Medicinal Product Designation promptly after the effective date of termination of this Agreement to Columbia.

4. The following sentence shall be added to Section 16(c):

This Agreement may be terminated by Company upon sixty (60) days' prior written notice to Columbia, provided that Company covenants that it is no longer discovering, developing, manufacturing, using, selling, offering for sale, importing, exporting, distributing, renting or leasing any Patent Products or Other Products, and will not do so in the future.

5. The following Section 16(i) shall be added to the Agreement:

i. Pre-expiration Termination. Except as provided in Section 16g, if the Agreement terminates before its expiration as indicated in Section 16b, Company shall i) not use or sell Products discovered, incorporating, or made using the Technical Information or Materials for the remainder of the term indicated in Section 16b and ii) upon Columbia's request, promptly transfer to Columbia all Material and all written copies of unpublished Technical Information in its possession and delete all the unpublished Technical Information from all computer databases.

6. Except as expressly set forth in this Fifth Amendment, the Agreement shall remain in full force and effect. If there is any inconsistency or conflict between this Fourth Amendment and the Agreement, the provisions of this Amendment shall govern and control. This Fifth Amendment may be executed in any number of counterparts, each of which shall be deemed an original, but all of which together shall constitute one and the same instrument. This Fifth Amendment shall be binding upon, and shall inure to the benefit of, the parties hereto and their respective successors and assigns.

IN WITNESS WHEREOF, the parties hereto have caused this Fifth Amendment to the License Agreement to be executed as of the date first above written.

**THE TRUSTEES OF COLUMBIA  
UNIVERSITY IN THE CITY OF NEW YORK**

By: /s/ Orin Herskowitz

Name: Orin Herskowitz

Title: Exec Dir, CTV

TTS #59587 (Original Agt #49055)

**BELITE BIO, INC**

By: /s/ Tom Lin

Name: Tom Lin

Title: Director

**FIRST AMENDMENT TO LBS-008 RESEARCH AND DEVELOPMENT  
SERVICES AGREEMENT**

This First Amendment to LBS-008 Research and Development Services Agreement (this “**Amendment**”), effective as of Feb 23, 2022 (“**Effective Date**”), is entered into by and between Belite Bio, Inc., a Cayman corporation, with contact office located at 5820 Oberlin Drive, Suite 101, San Diego CA, 92121 USA (“**Belite Inc**”) and Lin BioScience, Inc., a Taiwan corporation, located at 12F., No.68, Sec. 5, Zhongxiao E. Rd., Xinyi Dist., Taipei City 110, Taiwan (“**Lin Inc.**”).

**BACKGROUND**

- A. The Parties entered into that certain LBS-008 Research and Development Services Agreement, dated July 1st, 2021 (the “**Agreement**”), whereby Belite Inc and Lin Inc. set forth their agreements with respect to certain services to be provided by Lin Inc.
- B. In consideration of Taiwan’s laws and regulations, including but not limitation of the qualification of pharmaceutical firms of Pharmaceutical Affairs Act the Parties desire to amend the Agreement to clarify the terms specified herein.

NOW, **THEREFORE**, in consideration of the premises and mutual promises and covenants contained herein, the Parties hereto agree as follows:

1. Section 4 of the Agreement is hereby amended by deleting all of the current provisions of Section 4 and inserting in lieu thereof the following:

**“DELIVERABLES AND IPR”**

- (a) **Deliverables**. Anything discovered, invented, or developed by Lin Inc. or its personnel in the course of the Services (“**Inventions**”) and all Deliverables, including but not limited to the data, certificate, or designation obtained or received by Lin Inc. in the course of the Services, are and shall remain the sole and exclusive property of Belite Inc. Lin Inc. hereby assigns to Belite Inc all Lin Inc.’s right, title and interest in and to any Inventions and Deliverables. Lin Inc. agrees to (1) promptly and fully disclose any Inventions to Belite Inc, (2) assign all of Lin Inc.’s right, title and interest in and to any such Inventions and Deliverables to Belite Inc without other consideration or royalty, except the fees and expenses as prescribed in Section 3, and (3) execute all applications, assignments or other instruments reasonably requested by Belite Inc.
- (b) **IPR**. Belite Inc hereby grants Lin Inc. a revocable, non-exclusive, non-transferable, royalty-free license (with the right to grant and authorize sublicenses) under Belite Bio’s Retinol Binding Protein 4 (“**RBP4**”)-related patents in Taiwan, to the extent that is necessary for Lin Inc. to perform the Services. Lin Inc. acknowledges and agrees that Belite Inc is the sole and exclusive owner of all IPR that Lin Inc. will directly or indirectly manage, develop or assist in the performance of the Services.
2. The Agreement, as amended herein, is ratified and confirmed.

3. All other terms and conditions of the Agreement remain unchanged and in full force and effect.
4. This Amendment may be executed in counterparts (including by facsimile or other electronic transmission), all of which together shall constitute an agreement binding on all the Parties, notwithstanding that all such Parties are not signatories to the original or the same counterpart. Each Party shall become bound by this Amendment immediately upon affixing its signature hereto.

IN WITNESS WHEREOF, Belite Inc's and Lin Inc.'s authorized representatives have duly executed this Amendment below to indicate their assent to its terms:

**Belite Bio, Inc**

Signature: /s/ Tom Lin  
Print Name: Tom Lin  
Title: Director

**Lin BioScience, Inc.**

Signature: /s/ Tom Lin  
Print Name: Tom Lin  
Title: Chairman



## Significant Subsidiaries of the Registrant

<b>Significant Subsidiaries of the Registrant</b>	<b>Place of Incorporation</b>
Belite Bio Holdings Corp.	State of Delaware
Belite Bio, LLC	State of Delaware
RBP4 Pty Ltd	Australia
Belite Bio (HK) Limited	Hong Kong
Belite Bio (Shanghai) Limited	China

---

# FRIEDMAN LLP<sup>®</sup>

ACCOUNTANTS AND ADVISORS

## CONSENT OF INDEPENDENT REGISTERED PUBLIC ACCOUNTING FIRM

We consent to the inclusion in this Registration Statement on Form F-1 of our report dated March 15, 2022, with respect to our audits of consolidated financial statements of Belite Bio, Inc and Subsidiaries as of December 31, 2021 and 2020 and for each of the years in the two-year period ended December 31, 2021. We also consent to the reference to our firm under the heading “Experts” in the Registration Statement.

/s/ Friedman LLP

New York, New York  
April 5, 2022

One Liberty Plaza, 165 Broadway, 21<sup>st</sup> Floor, New York, NY 10006 p 212.842.7000

[friedmanllp.com](http://friedmanllp.com)

Your livelihood, empowered.

An Independent Member Firm of DFK with offices worldwide.



# 通商律師事務所

COMMERCE & FINANCE LAW OFFICES

中国上海市南京西路 1515 号静安嘉里中心一座 10 层 200040  
10/F, Tower 1, Jing An Kerry Centre, 1515 West Nanjing Road, Shanghai 200040, China  
电话 Tel: +86 21 6019 2600 传真 Fax: +86 21 6019 2697  
网址 Web: www.tongshang.com

April 5, 2022

Belite Bio, Inc  
5820 Oberlin Drive, Suite 101  
San Diego, CA 92121

Dear Sir/Madam,

We have acted as legal counsel as to the laws of the People's Republic of China to Belite Bio, Inc (the "**Company**"), a company incorporated under the laws of the Cayman Islands, on certain matters covered by our legal opinion in connection with (i) the proposed initial public offering (the "**Offering**") by the Company of American Depositary Shares (the "**ADSs**"), in accordance with the Company's registration statement on Form F-1, including all amendments or supplements thereto, filed by the Company with the U.S. Securities and Exchange Commission under the U.S. Securities Act of 1933, as amended, and (ii) the Company's proposed listing of the ADSs on the Nasdaq Capital Market.

We hereby consent to the use and reference of our name under the headings "Risk Factors", "Legal Matters" and elsewhere, and the filing of this letter and the legal opinion as exhibits to, the Registration Statement.

In giving such consent, we do not thereby admit that we fall within the category of the person whose consent is required under Section 7 of the U.S. Securities Act of 1933, as amended, or the regulations promulgated thereunder.

Yours sincerely,

/s/ Commerce & Finance Law Offices  
Commerce & Finance Law Offices

---

## CODE OF BUSINESS CONDUCT AND ETHICS

## I. PURPOSE

This Code of Business Conduct and Ethics (the "Code") contains general guidelines for conducting the business of Belite Bio, Inc, a Cayman Islands company, and its subsidiaries and consolidated affiliated entity (collectively, the "Company," consistent with the highest standards of business ethics, and is intended to qualify as a "code of ethics" within the meaning of Section 406 of the Sarbanes-Oxley Act of 2002 and the rules promulgated thereunder. To the extent this Code requires a higher standard than required by commercial practice or applicable laws, rules or regulations, we adhere to these higher standards.

This Code is designed to deter wrongdoing and to promote:

- honest and ethical conduct, including the ethical handling of actual or apparent conflicts of interest between personal and professional relationships;
- full, fair, accurate, timely, and understandable disclosure in reports and documents that the Company files with, or submits to, the U.S. Securities and Exchange Commission (the "SEC") and in other public communications made by the Company;
- compliance with applicable laws, rules and regulations;
- prompt internal reporting of violations of the Code; and
- accountability for adherence to the Code.

## II. APPLICABILITY

This Code applies to all directors, officers and employees of the Company, whether they work for the Company on a full-time, part-time, consultative or temporary basis (each, an "employee" and collectively, the "employees"). Certain provisions of the Code apply specifically to our chief executive officer, chief financial officer, other chief senior officers, senior finance officer, controller, vice presidents and any other persons who perform similar functions for the Company (each, a "senior officer," and collectively, the "senior officers").

The Board of Directors of the Company (the "Board") has appointed the Company's Chief Financial Officer, as the Compliance Officer for the Company (the "Compliance Officer"). If you have any questions regarding the Code or would like to report any violation of the Code, please contact the Compliance Officer.

## III. CONFLICTS OF INTEREST

*Identifying Conflicts of Interest*

A conflict of interest occurs when an employee's private interest interferes, or appears to interfere, in any way with the interests of the Company as a whole. An employee should actively avoid any private interest that may impact such employee's ability to act in the interests of the Company or that may make it difficult to perform the employee's work objectively and effectively. In general, the following should be considered conflicts of interest:

- Competing Business. No employee may be employed by a business that competes with the Company or deprives it of any business.
-

· Corporate Opportunity. No employee should use corporate property, information or his or her position with the Company to secure a business opportunity that would otherwise be available to the Company. If an employee discovers a business opportunity that is in the Company's line of business through the use of the Company's property, information or position, the employee must first present the business opportunity to the Company before pursuing the opportunity in his or her individual capacity.

· Financial Interests.

(i) No employee may have any financial interest (ownership or otherwise), either directly or indirectly through a spouse or other family member, in any other business or entity if such interest adversely affects the employee's performance of duties or responsibilities to the Company, or requires the employee to devote time to it during such employee's working hours at the Company;

(ii) No employee may hold any ownership interest in a privately held company that is in competition with the Company;

(iii) An employee may hold up to 5% ownership interest in a publicly traded company that is in competition with the Company; provided that if the employee's ownership interest in such publicly traded company increases to more than 5%, the employee must immediately report such ownership to the Compliance Officer;

(iv) No employee may hold any ownership interest in a company that has a business relationship with the Company if such employee's duties at the Company include managing or supervising the Company's business relations with that company; and

(v) Notwithstanding the other provisions of this Code,

(a) a director or any family member of such director (collectively, "Director Affiliates") or a senior officer or any family member of such senior officer (collectively, "Officer Affiliates") may continue to hold his or her investment or other financial interest in a business or entity (an "Interested Business") that:

(1) was made or obtained either (x) before the Company invested in or otherwise became interested in such business or entity; or (y) before the director or senior officer joined the Company (for the avoidance of doubt, regardless of whether the Company had or had not already invested in or otherwise become interested in such business or entity at the time the director or senior officer joined the Company); or

(2) may in the future be made or obtained by the director or senior officer, provided that at the time such investment or other financial interest is made or obtained, the Company has not yet invested in or otherwise become interested in such business or entity;

provided that such director or senior officer shall disclose such investment or other financial interest to the Board;

(b) an interested director or senior officer shall refrain from participating in any discussion among senior officers of the Company relating to an Interested Business and shall not be involved in any proposed transaction between the Company and an Interested Business; and

(c) before any Director Affiliate or Officer Affiliate (i) invests, or otherwise acquires any equity or other financial interest, in a business or entity that is in competition with the Company; or (ii) enters into any transaction with the Company, the related director or senior officer shall obtain prior approval from the Audit Committee of the Board.

---

For purposes of this Code, a company or entity is deemed to be “in competition with the Company” if it competes with the Company’s business of researching, developing, manufacturing and commercialization of biopharmaceutical drugs or other therapeutic treatments for age-related metabolic diseases and conditions, including macular degeneration, liver disease and diabetes.

· Loans or Other Financial Transactions. No employee may obtain loans or guarantees of personal obligations from, or enter into any other personal financial transaction with, any company that is a material customer, supplier or competitor of the Company. This guideline does not prohibit arms-length transactions with recognized banks or other financial institutions.

· Service on Boards and Committees. No employee shall serve on a board of directors or trustees or on a committee of any entity (whether profit or not-for-profit) whose interests could reasonably be expected to conflict with those of the Company. Employees must obtain prior approval from the Board before accepting any such board or committee position. The Company may revisit its approval of any such position at any time to determine whether an employee’s service in such position is still appropriate.

The above is in no way a complete list of situations where conflicts of interest may arise. The following questions might serve as a useful guide in assessing a potential conflict of interest situation not specifically addressed above:

- Is the action to be taken legal?
- Is it honest and fair?
- Is it in the best interests of the Company?

#### ***Disclosure of Conflicts of Interest***

The Company requires that employees fully disclose any situations that could reasonably be expected to give rise to a conflict of interest. If an employee suspects that he or she has a conflict of interest, or a situation that others could reasonably perceive as a conflict of interest, the employee must report it immediately to the Compliance Officer. Conflicts of interest may only be waived by the Board, or the appropriate committee of the Board, and will be promptly disclosed to the public to the extent required by law and applicable rules of the Nasdaq Stock Market.

#### ***Family Members and Work***

The actions of family members outside the workplace may also give rise to conflicts of interest because they may influence an employee’s objectivity in making decisions on behalf of the Company. If a member of an employee’s family is interested in doing business with the Company, the criteria as to whether to enter into or continue the business relationship and the terms and conditions of the relationship must be no less favorable to the Company compared with those that would apply to an unrelated party seeking to do business with the Company under similar circumstances.

Employees should report any situation involving family members that could reasonably be expected to give rise to a conflict of interest to their supervisor or the Compliance Officer. For purposes of this Code, “family members” or “members of employee’s family” include an employee’s spouse, siblings, parents, in-laws and children.

---

#### **IV. GIFTS AND ENTERTAINMENT**

The giving and receiving of appropriate gifts may be considered common business practice. Appropriate business gifts and entertainment are welcome courtesies designed to build relationships and understanding among business partners. However, gifts and entertainment should never compromise, or appear to compromise, an employee's ability to make objective and fair business decisions.

It is the responsibility of employees to use good judgment in this area. As a general rule, employees may give or receive gifts or entertainment to or from customers or suppliers only if the gift or entertainment is in compliance with applicable law, insignificant in amount and not given in consideration or expectation of any action by the recipient. All gifts and entertainment expenses made on behalf of the Company must be properly accounted for on expense reports.

We encourage employees to submit gifts received to the Company.

Bribes and kickbacks are criminal acts, strictly prohibited by law. An employee must not offer, give, solicit or receive any form of bribe or kickback anywhere in the world.

#### **V. FCPA COMPLIANCE**

The U.S. Foreign Corrupt Practices Act ("FCPA") prohibits giving anything of value, directly or indirectly, to officials of foreign governments or foreign political candidates in order to obtain or retain business. A violation of FCPA does not only violate the Company's policy but also constitute a civil or criminal offense under FCPA which the Company is subject to after the Effective Time. No employee shall give or authorize directly or indirectly any illegal payments to government officials of any country. While the FCPA does, in certain limited circumstances, allow nominal "facilitating payments" to be made, any such payment must be discussed with and approved by an employee's supervisor (in the case of the chief executive officers, by the board of directors) in advance before it can be made.

#### **VI. PROTECTION AND USE OF COMPANY ASSETS**

Employees should protect the Company's assets and ensure their efficient use for legitimate business purposes only. Theft, carelessness and waste have a direct impact on the Company's profitability. Any use of the funds or assets of the Company, whether for personal gain or not, for any unlawful or improper purpose is strictly prohibited.

To ensure the protection and proper use of the Company's assets, each employee should:

- Exercise reasonable care to prevent theft, damage or misuse of Company property;
- Promptly report any actual or suspected theft, damage or misuse of Company property;
- Safeguard all electronic programs, data, communications and written materials from unauthorized access; and
- Use Company property only for legitimate business purposes.

Except as approved in advance by the Chief Executive Officer or Chief Financial Officer of the Company, the Company prohibits political contributions (directly or through trade associations) by any employee on behalf of the Company. Prohibited political contributions include:

- any contributions of the Company's funds or other assets for political purposes;
  - encouraging individual employees to make any such contribution; and
  - reimbursing an employee for any political contribution.
-

## **VII. INTELLECTUAL PROPERTY AND CONFIDENTIALITY**

Employees should abide by the Company's rules and policies in protecting the intellectual property and confidential information, including the following:

- All inventions, creative works, computer software, and technical or trade secrets developed by an employee in the course of performing the employee's duties or primarily through the use of the Company's assets or resources while working at the Company shall be the property of the Company.
- Employees should maintain the confidentiality of information entrusted to them by the Company or the entities with which the Company has business relationships, except when disclosure is authorized or legally mandated. Confidential information includes all non-public information that might be of use to competitors, or harmful to the company or its business associates, if disclosed.
- The Company maintains a strict confidentiality policy. During an employee's term of employment with the Company, the employee shall comply with any and all written or unwritten rules and policies concerning confidentiality and shall fulfill the duties and responsibilities concerning confidentiality applicable to the employee.
- In addition to fulfilling the responsibilities associated with his or her position in the Company, an employee shall not, without obtaining prior approval from the Company, disclose, announce or publish trade secrets or other confidential business information of the Company, nor shall an employee use such confidential information outside the course of his or her duties to the Company.
- Even outside the work environment, an employee must maintain vigilance and refrain from disclosing important information regarding the Company or its business, business associates or employees.
- An employee's duty of confidentiality with respect to the confidential information of the Company survives the termination of such employee's employment with the Company for any reason until such time as the Company discloses such information publicly or the information otherwise becomes available in the public sphere through no fault of the employee.
- Upon termination of employment, or at such time as the Company requests, an employee must return to the Company all of its property without exception, including all forms of medium containing confidential information, and may not retain duplicate materials.

## **VIII. ACCURACY OF FINANCIAL REPORTS AND OTHER PUBLIC COMMUNICATIONS**

Upon the completion of the Company's initial public offering, the Company will be required to report its financial results and other material information about its business to the public and the SEC. It is the Company's policy to promptly disclose accurate and complete information regarding its business, financial condition and results of operations. Employees must strictly comply with all applicable standards, laws, regulations and policies for accounting and financial reporting of transactions, estimates and forecasts. Inaccurate, incomplete or untimely reporting will not be tolerated and can severely damage the Company and result in legal liability.

---



Employees should be on guard for, and promptly report, any possibility of inaccurate or incomplete financial reporting. Particular attention should be paid to:

- Financial results that seem inconsistent with the performance of the underlying business;
- Transactions that do not seem to have an obvious business purpose; and
- Requests to circumvent ordinary review and approval procedures.

The Company's senior financial officers and other employees working in the finance department have a special responsibility to ensure that all of the Company's financial disclosures are full, fair, accurate, timely and understandable. Any practice or situation that might undermine this objective should be reported to the Compliance Officer.

Employees are prohibited from directly or indirectly taking any action to coerce, manipulate, mislead or fraudulently influence the Company's independent auditors for the purpose of rendering the financial statements of the Company materially misleading. Prohibited actions include but are not limited to:

- issuing or reissuing a report on the Company's financial statements that is not warranted in the circumstances (due to material violations of U.S. GAAP, generally accepted auditing standards or other professional or regulatory standards);
- not performing audit, review or other procedures required by generally accepted auditing standards or other professional standards;
- not withdrawing an issued report when withdrawal is warranted under the circumstances; or
- not communicating matters required to be communicated to the Company's Audit Committee.

#### **IX. COMPANY RECORDS**

Accurate and reliable records are crucial to the Company's business and form the basis of its earnings statements, financial reports and other disclosures to the public. The Company's records are a source of essential data that guides business decision-making and strategic planning. Company records include, but are not limited to, booking information, payroll, timecards, travel and expense reports, e-mails, accounting and financial data, measurement and performance records, electronic data files and all other records maintained in the ordinary course of business.

All Company records must be complete, accurate and reliable in all material respects. There is never an acceptable reason to make false or misleading entries. Undisclosed or unrecorded funds, payments or receipts are strictly prohibited. An employee is responsible for understanding and complying with the Company's record keeping policy. An employee should contact the Compliance Officer if he or she has any questions regarding the record keeping policy.

#### **X. COMPLIANCE WITH LAWS AND REGULATIONS**

Each employee has an obligation to comply with the laws of the cities, provinces, regions and countries in which the Company operates. This includes, without limitation, laws covering commercial bribery and kickbacks, patents, copyrights, trademarks and trade secrets, information privacy, insider trading, offering or receiving gratuities, employment harassment, environmental protection, occupational health and safety, false or misleading financial information, misuse of corporate assets and foreign currency exchange activities. Employees are expected to understand and comply with all laws, rules and regulations that apply to their positions at the Company. If any doubt exists about whether a course of action is lawful, the employee should seek advice immediately from the Compliance Officer.

---

## **XI. DISCRIMINATION AND HARASSMENT**

The Company is firmly committed to providing equal opportunity in all aspects of employment and will not tolerate any illegal discrimination or harassment based on race, ethnicity, religion, gender, age, national origin or any other protected class. For further information, employees should consult the Compliance Officer.

## **XII. FAIR DEALING**

Each employee should endeavor to deal fairly with the Company's customers, suppliers, competitors and employees. None should take unfair advantage of anyone through manipulation, concealment, abuse of privileged information, misrepresentation of material facts, or any other unfair-dealing practice.

## **XIII. HEALTH AND SAFETY**

The Company strives to provide employees with a safe and healthy work environment. Each employee has responsibility for maintaining a safe and healthy workplace for other employees by following environmental, safety and health rules and practices and reporting accidents, injuries and unsafe equipment, practices or conditions. Violence or threats of violence are not permitted.

Each employee is expected to perform his or her duty to the Company in a safe manner, not under the influence of alcohol, illegal drugs or other controlled substances. The use of illegal drugs or other controlled substances in the workplace is prohibited.

## **XIV. VIOLATIONS OF THE CODE**

All employees have a duty to report any known or suspected violation of this Code, including any violation of laws, rules, regulations or policies that apply to the Company. Reporting a known or suspected violation of this Code by others will not be considered an act of disloyalty, but an action to safeguard the reputation and integrity of the Company and its employees.

If an employee knows of or suspects a violation of this Code, it is such employee's responsibility to immediately report the violation to the Compliance Officer, who will work with the employee to investigate his or her concern. All questions and reports of known or suspected violations of this Code will be treated with sensitivity and discretion. The Compliance Officer and the Company will protect the employee's confidentiality to the extent possible, consistent with the law and the Company's need to investigate the employee's concern.

It is the Company's policy that any employee who violates this Code will be subject to appropriate discipline, including termination of employment, based upon the facts and circumstances of each particular situation. An employee's conduct, if it does not comply with the law or with this Code, can result in serious consequences for both the employee and the Company.

The Company strictly prohibits retaliation against an employee who, in good faith, seeks help or reports known or suspected violations. An employee inflicting reprisal or retaliation against another employee for reporting a known or suspected violation will be subject to disciplinary action, including termination of employment.

## **XV. WAIVERS OF THE CODE**

Waivers of this Code will be granted on a case-by-case basis and only in extraordinary circumstances. Waivers of this Code may be made only by the Board, or the appropriate committee of the Board; provided that waiver of this Code for executive officers or directors must be made by the Board, and should be promptly disclosed to the public if so required by and in accordance with applicable laws and regulations and rules of the Nasdaq Stock Market.

## **XVI. CONCLUSION**

This Code contains general guidelines for conducting the business of the Company consistent with the highest standards of business ethics. If employees have any questions about these guidelines, they should contact the Compliance Officer. We expect all employees to adhere to these standards. Each employee is separately responsible for his or her actions. Conduct that violates the law or this Code cannot be justified by claiming that it was ordered by a supervisor or someone in higher management positions. If an employee engages in conduct prohibited by the law or this Code, such employee will be deemed to have acted outside the scope of his or her employment. Such conduct will subject the employee to disciplinary action, including termination of employment.

---

通商律師事務所  
COMMERCE & FINANCE LAW OFFICES

中国上海市南京西路1515号静安嘉里中心一座10层 200040  
10/F, Tower 1, Jing An Kerry Centre, 1515 West Nanjing Road, Shanghai 200040, China  
电话 Tel: +86 21 6019 2600 传真 Fax: +86 21 6019 2697  
电邮 Email: shanghai@tongshang.com 网址 Web: www.tongshang.com

April 5, 2022

Belite Bio, Inc

Dear Mesdames/Sirs,

1. We are lawyers qualified in the People's Republic of China (the "PRC") and are qualified to issue opinions on the PRC Laws (as defined in Section 3). For the purpose of this legal opinion (this "Opinion"), the PRC does not include the Hong Kong Special Administrative Region, the Macau Special Administrative Region and Taiwan.
2. We act as the PRC counsel to Belite Bio, Inc (the "Company"), a company incorporated under the laws of the Cayman Islands, on certain matters covered by this opinion in connection with (a) the proposed initial public offering (the "Offering") by the Company of American Depositary Shares (the "ADSS"), in accordance with the Company's registration statement on Form F-1, including all amendments or supplements thereto, filed by the Company with the U.S. Securities and Exchange Commission (the "SEC") under the U.S. Securities Act of 1933, as amended, and (b) the Company's proposed listing of the ADSs on the Nasdaq Capital Market (the "Nasdaq").
3. The following terms as used in this Opinion are defined as follows:

"Article 177"

means Article 177 of the Securities Law, which stipulates as follows:

*The securities regulatory authority of the State Council may establish cooperative mechanisms in conjunction with the securities regulatory authorities of any other jurisdictions for cross-border supervision and administration.*

*Overseas securities regulatory authorities shall not directly initiate investigation and obtain evidence within the territory of the PRC. Without the consent of the securities regulatory authority of the State Council and the relevant competent department under the State Council, no entity or individual shall provide overseas the documents and materials relating to securities business activities.*

"Cyber Security Law"

means the Cyber Security Law of the PRC promulgated by the Standing Committee of the National People's Congress on November 7, 2016, which became effective on June 1, 2017.

“ <u>PRC Laws</u> ”	means any and all officially published laws, regulations, statutes, rules, decrees, notices, and supreme court’s judicial interpretations currently in force and publicly available in the PRC as of the date hereof.
“ <u>PRC Subsidiary</u> ”	means Belite Bio (Shanghai) Limited (倍亮生技医药 (上海) 有限公司)
“ <u>Prospectus</u> ”	means the prospectus, including all amendments or supplements thereto, that forms part of the registration statement.
“ <u>Securities Law</u> ”	means the Securities Law of the PRC promulgated by the Standing Committee of the National People’s Congress on December 28, 2019, which became effective on March 1, 2020.

4. In order to issue this opinion, we have reviewed certain matters relating to PRC Laws that are relevant to the Offering (limited to the issues covered by this opinion), and we have examined all documentation and other materials provided to us by the Company and its PRC Subsidiary in relation to the issues covered by this opinion.

In examining the documents and for the purpose of giving this Opinion, we have assumed the genuineness of all signatures, chops and seals, the authenticity of all the documents submitted to us as originals and the conformity with authentic originals of documents submitted to us as copies. We have also assumed that the documents from the time they were presented to us up to the date of this legal opinion have remained in full force and effect and that none of the documents has been revoked, amended, varied or supplemented. We have further assumed the accuracy and completeness of all factual statements in the documents. Where important facts were not independently established to us or where important files were not sufficiently provided to us, we have relied upon certificates issued by governmental agents and documents, materials, statements and representations made to us by representatives of the Company and its PRC Subsidiary. We have assumed that no information which is relevant to its Offering and this opinion has been withheld from us by the Company or its PRC Subsidiary, and that all covenants, representations and warranties in the commitment letter or other similar documents provided by the Company, its PRC Subsidiary and/or their senior management are and remain accurate and true in all respects.

5. Based upon the foregoing and subject to the qualifications set out below, we are of the opinion that:

- (1) Given that (i) the first paragraph of Article 177 describes the cooperation for cross-border supervision and administration and (ii) the first sentence of the second paragraph of Article 177 stipulates explicitly that the restricted activities for the overseas securities regulatory authorities are activities relating to direct investigation and evidence collection, unless the relevant governmental or regulatory authorities stipulate otherwise separately, the documents and materials described in the second sentence of the second paragraph of Article 177 is with and limited to the context of investigation and evidence collection rather than the documents and materials in connection with customary actions related to the listing application and non-investigative customary regulatory activities of Nasdaq after the listing of the Company.
- (2) Though the first sentence of the second paragraph of Article 177 prohibits overseas securities regulatory authorities from direct investigation and evidence collection within the territory of the PRC, it doesn't prohibit overseas securities regulatory authorities from initiating activities relating to investigation and evidence collection outside the territory of the PRC. In addition, instead of direct investigation and evidence collection within the territory of the PRC, overseas securities regulatory authorities may seek for cooperation according to any securities regulatory cooperative agreement or memorandum agreed upon between such overseas securities regulatory authorities and the securities regulatory authority of the State Council of the PRC.
- (3) There is no specific definition of overseas securities regulatory authority under the Securities Law. In China, China Securities Regulatory Commission ("CSRC") is a securities regulatory authority. Based on our understanding of the PRC Laws, if the SEC plays a similar role as CSRC in the securities administration in the United States, it may be deemed an overseas securities regulatory authority. Absent of any definition of overseas securities regulatory authorities in the Securities Law and any implementation rules thereof, it remains unclear whether Nasdaq would be deemed overseas securities regulatory authorities under the Securities Law.
- (4) As discussed in item (2) above, the Article 177 does not prohibit overseas securities regulatory authorities from initiating activities relating to investigation and evidence collection outside the territory of the PRC. In case of any investigation and evidence collection activities within the territory of the PRC, overseas securities regulatory authorities may seek for cooperation according to any securities regulatory cooperative agreement or memorandum agreed upon between such overseas securities regulatory authorities and the securities regulatory authority of the State Council of the PRC.
- (5) Under the PRC Laws, investigation and evidence collection activities are initiated by securities regulatory authorities for specific reasons and subject to specific conditions, so customary actions related to the listing application and non-investigative customary regulatory activities are not investigation and evidence collection activities. As such, unless the relevant governmental or regulatory authorities stipulate otherwise separately, documents and materials provided to Nasdaq in the context of a listing application or in connection with regulatory requests or inquiries relating to continued listing on the Nasdaq are not investigation and evidence collection activities.

- (6) Notwithstanding the analysis above, when providing documents or materials of securities business activities, whether to overseas institutions or institutions inside the PRC, relevant entities and individuals may be subject to other PRC Laws in terms of national security and secrecy.
  - (7) To the best of our knowledge after due inquiries, the Company currently does not have any substantive operations in China. Therefore, we are of the opinion that Article 177 of the PRC Securities Law does not apply to documents and materials submitted to Nasdaq in connection with its application for listing on Nasdaq, nor it requires the Company to obtain the approval from CSRC.
  - (8) As of the date of this Opinion, we have not received any official feedback or comment in connection with the analysis in Section 5(1)-(7) from CSRC.
  - (9) The PRC Subsidiary has been duly incorporated and validly exists as a limited liability company under the PRC Laws. The ownership structure of the PRC Subsidiary as set forth in the Prospectus, both currently and immediately after giving effect to the Offering, will not result in any violation of the PRC Laws.
  - (10) To the best of our knowledge after due inquiries, the Company's main business operation is not located in the PRC, and its PRC Subsidiary has not had any substantive operation nor has it dealt with important data or significant amounts of personal information as of the date of this Opinion. In addition, as confirmed by the Company, as of the date of this Opinion, it does not have any intention to have its PRC Subsidiary commence substantive operation or deal with important data or significant amounts of personal information in the near future. Therefore, we are of the opinion that Article 37 of the Cyber Security Law does not apply to documents and materials submitted to Nasdaq in connection with the Company's application for listing on Nasdaq, nor regulatory approval from CSRC or Cyberspace Administration of China ("CAC") is required to be obtained before the Company's listing on the Nasdaq.
  - (11) The statements set forth under the caption "Regulations-PRC regulation" and elsewhere in the Prospectus to the extent they constitute summaries of the PRC Laws or legal conclusions in respect of the PRC Laws, are accurate in all material respects.
6. This Opinion is subject to the following qualifications:
- (1) This Opinion relates only to the PRC Laws and we express no opinion as to any other laws and regulations. There is no guarantee that any of the PRC Laws, or the interpretation thereof or enforcement therefor, will not be changed, amended or replaced in the immediate future or in the longer term with or without retrospective effect.
  - (2) The Standing Committee of the National People's Congress shall have the final interpretation right of the Securities Law and the Cyber Security Law, and CSRC and CAC shall have the right to interpret the implementation of the Securities Law and the Cyber Security Law to some extent. There is no guarantee that the relevant governmental or regulatory authorities will not take a view that is contrary to or otherwise different from our Opinion stated above.

- (3) This Opinion is intended to be used in the context which is specifically referred to herein and each section should be looked on as a whole regarding the same subject matter and no part shall be extracted for interpretation separately from this Opinion.
- (4) This Opinion is subject to the effects of (i) certain legal or statutory principles affecting the enforceability of contractual rights generally under the concepts of public interest, national security, good faith and fair dealing, applicable statutes of limitation, and the limitations by bankruptcy, insolvency, reorganization or similar laws affecting the enforcement of creditor's rights generally; (ii) any circumstance in connection with formulation, execution or performance of any legal documents that would be deemed materially mistaken, clearly unconscionable or fraudulent; (iii) judicial discretion with respect to the availability of injunctive relief, the calculation of damages, and the entitlement of attorneys' fees and other costs; and (iv) the discretion of any competent PRC legislative, administrative or judicial bodies in exercising their authority in connection with the interpretation, implementation and application of relevant PRC Laws.

This Opinion is given for the benefit of the addressee hereof, and without our express prior written consent, may not be relied upon by any person or entity other than the addressee. This Opinion is rendered to you for the purpose hereof only and shall not be issued, quoted or disclosed nor shall a copy be given to any person (apart from Nasdaq) for any other purpose without our express prior written consent.

[The remainder of this page is intentionally left blank]

[Signature Page]

Yours sincerely,

/s/ Commerce & Finance Law Offices  
Commerce & Finance Law Offices

---



April 5, 2022

BELITE BIO, INC  
5820 Oberlin Drive, Suite 101  
San Diego, CA 92121

Ladies and Gentlemen:

Pursuant to Rule 438 under the Securities Act of 1933, as amended, I hereby consent to the reference of my name as a director of BELITE BIO, INC (the "**Company**"), effective immediately upon the effectiveness of the Company's registration statement on Form F-1 filed by the Company with the U.S. Securities and Exchange Commission.

Sincerely yours,

/s/ John M. Longo

Name: John M. Longo

---

April 5, 2022

BELITE BIO, INC  
5820 Oberlin Drive, Suite 101  
San Diego, CA 92121

Ladies and Gentlemen:

Pursuant to Rule 438 under the Securities Act of 1933, as amended, I hereby consent to the reference of my name as a director of BELITE BIO, INC (the “**Company**”), effective immediately upon the effectiveness of the Company’s registration statement on Form F-1 filed by the Company with the U.S. Securities and Exchange Commission.

Sincerely yours,

/s/Ita Lu

\_\_\_\_\_  
Name: Ita Lu

---

April 5, 2022

BELITE BIO, INC  
5820 Oberlin Drive, Suite 101  
San Diego, CA 92121

Ladies and Gentlemen:

Pursuant to Rule 438 under the Securities Act of 1933, as amended, I hereby consent to the reference of my name as a director of BELITE BIO, INC (the "**Company**"), effective immediately upon the effectiveness of the Company's registration statement on Form F-1 filed by the Company with the U.S. Securities and Exchange Commission.

Sincerely yours,

/s/ Gary C. Biddle

Name: Gary C. Biddle

---

## Calculation of Filing Fee Tables

F-1  
(Form Type)

**Belite Bio, Inc**  
(Exact Name of Registrant as Specified in its Charter)

Table 1: Newly Registered Securities

	Security Type	Security Class Title	Fee Calculation or Carry Forward Rule	Amount Registered	Proposed Maximum Offering Price Per Unit	Maximum Aggregate Offering Price <sup>(1)(2)</sup>	Fee Rate	Amount of Registration Fee
Fees to Be Paid	Equity	Ordinary Shares, par value US\$0.0001 per share <sup>(3)</sup>	457(o)	—	—	\$ 46,000,000	0.0000927	\$ 4,264.20
	Equity	Warrants to purchase Ordinary Shares represented by ADSs issued to the representative of the underwriters (“Representative’s Warrants”)	457(g)	—	—	—	—	— <sup>(4)</sup>
	Equity	Ordinary Shares underlying Representative’s Warrants	457(g)	—	—	\$ 1,150,000	0.0000927	\$ 106.61
		Total Offering Amounts				\$ 47,150,000		\$ 4,370.81
		Total Fees Previously Paid				—		—
		Total Fee Offsets				—		—
		Net Fee Due				\$ 4,370.81		

<sup>(1)</sup> Includes ordinary shares that are issuable upon the exercise of the underwriters’ option to purchase additional ADSs.

<sup>(2)</sup> Estimated solely for the purpose of determining the amount of registration fee in accordance with Rule 457(o) under the Securities Act of 1933.

<sup>(3)</sup> American depositary shares issuable upon deposit of ordinary shares registered hereby will be registered under a separate registration statement on Form F-6 (Registration No. 333- ). Each American depositary share represents one ordinary share.

<sup>(4)</sup> In accordance with Rule 457(g), the entire registration fee for the warrants is allocated to the common stock underlying the warrants, and no separate fee is payable for the warrants.